

Door opening up to 1 m/s:
the fastest sectional door
from Europe's no. 1

INDUSTRIAL SECTIONAL DOORS

NEW NetControl for intelligent networking of operator controls and integration into local networks

HÖRMANN





4

Good reasons
to try Hörmann



22

Application areas



38

Versions.
Accessories.
Technology.

Brand quality made in Germany



The family-owned company Hörmann offers all important construction components for building and renovating projects from a single source. We manufacture in highly specialised factories using state-of-the-art production technologies. Our employees work intensively on new products, continual further developments and improvements to details. The results are patents and unique products on the market.





WE THINK AND ACT GREEN. As a family business, we are very conscious of our responsibility to future generations and will offer all products for construction projects as CO₂-neutral versions upon customer request. In this way, customers have the option to offset remaining emissions and make a contribution to climate protection when purchasing our products. The Hörmann sustainability strategy aims to reduce and avoid emissions. We cover 100% of our electrical power needs at all European production sites* with genuine green electricity from renewable sources. We also apply many other measures to reduce our consumption and save more than 75000 tonnes of CO₂ each year. We work with ClimatePartner to offset the remaining emissions by supporting certified climate protection projects.

* Except in France



You can find further information at
www.hoermann.com/sustainability



ClimatePartner
certified product
climate-id.com/FYZNUF



CO₂
measure
reduce
contribute

Sustainable planning for trend-setting construction

Experienced specialists within our customer-oriented sales organisation accompany you from the planning stage, through technical clarification up to the final building inspection. Complete working documentation, such as, e.g. technical manuals, are always accessible and up-to-date at www.hoermann.de





SUSTAINABILITY DOCUMENTED. Hörmann has already received confirmation of sustainability through an Environmental Product Declaration (EPD) in accordance with ISO 14025 from the Institut für Fenstertechnik (ift – Institute of window technology) in Rosenheim, Germany. This EPD was created based on EN ISO 14025:2011 and EN 15804:2012 + A1:2013. In addition, the general guidelines for the preparation of type III Environmental Product Declaration apply. The declaration is based on PCR documents “PCR Part A” PCR-A-0.3.2018 and “Doors” PCR-TT-2.2:2018.



PRODUCT PORTAL FOR ARCHITECTS AND PLANNERS.

Clearly structured navigation and a search function provide faster access to texts for invitations to tender, technical data, certificates, CAD drawings and much more. In addition, BIM data can be provided for many products for the Building Information Modelling process, enabling efficient planning, drafting, construction and management of buildings. Photos and photo-realistic presentations provide additional information on many products.



PRODUCTS
FOR BIM

We are a member of the professional association for digital building products in the Federal Association of Building Systems e.V.



Texts for invitations to tender, CAD drawings, BIM data and documents for your project can be found at www.hormann.co.uk/architects-service/architects-programme



ENERGY SAVINGS COMPASS. Hörmann’s energy savings compass shows how industrial door systems and loading technology are planned with energy efficiency and sustainability in mind. An integrated calculation module estimates the amortisation time for door and loading technology systems. The energy savings compass is available as a web-based interface for PC / Mac and mobile end devices.

Easy to fit and service

Precisely fitting connections, a small number of components and pressed-in bolts enable fast, precise fitting. In addition, the latest generation of industrial sectional doors can also be integrated into digital service and remote maintenance concepts. This lowers the maintenance and service costs, making Hörmann industrial sectional doors economical and sustainable.





Round-the-clock service

FAST SERVICE. Our teams of highly qualified specialists travel all around Germany. But Hörmann also offers consulting, maintenance and repairs in many other countries. Our network of over 500 service technicians guarantees speed and flexibility. We are available around the clock. Our customers can rely on us.



10-year guaranteed availability

HÖRMANN SPARE PARTS. It goes without saying that spare parts for doors, operators, and controls are original Hörmann parts that come with a guaranteed availability of 10 years.



BlueControl

SMART DOOR CONFIGURATION. Initial start-up, service and maintenance of industrial doors is easy and convenient with the BlueControl app.



NEW. NetControl

NEW. INTELLIGENT NETWORKING. The NetControl gateway displays important information about the doors, such as status, error messages, cycles, opening duration and maintenance instructions. This reduces costs for service visits and prevents downtime through preventive replacement of wear parts – for robust logistics processes concerning your door system.

→ For further information, see from page 88.



Long-lasting design

Rollers with ball-bearings, sturdy section connections and an optimal counterbalance enable over 25000 actuations – and up to 200000 with special equipment. The optional plastic frame shoe also provides the frame with lasting protection against corrosion.





Only from Hörmann

Double radius of 510 mm

LOW-WEAR DOOR TRAVEL. The frame construction with a large double radius and optimally dimensioned rollers is gentle on all mechanical door elements.



Only from Hörmann

Twin rollers on the top door section

QUIET OPENING AND CLOSING. The standard twin rollers **1** on the top section ensure quiet door travel, especially during closing. With optional 2-component rollers **2** travel noises are reduced by up to an additional 5 dB(A). This is a decisive advantage not only for doors in residential buildings.



Only from Hörmann

Plastic frame shoe

CORROSION PROTECTION. The optional fibreglass-reinforced plastic frame shoe **3** prevents the frame from coming into direct contact with moisture on the floor and provides lasting protection against corrosion. Together with the door's bottom seal, the frame shoe makes for a bottom edge that is visually appealing.

→ For further information, see from page 56.

Energy-saving operator convenience

With fast door operators, you save valuable energy and speed up your work processes as well. Whatever your requirements for performance, speed and convenience, we offer you perfectly matched operator solutions with suitable security features, operating aids and signal transmitters. This optimally supports the processes in your company, making it an investment that quickly pays off.





Soft start
Soft stop



Opening speed up to 1.0 m/s



Electricity cost saving of approx. 80%*

* Power consumption in energy-saving mode without any connected accessories: below 2 W/h

ULTRA-FAST DOOR OPENING. Shaft operator WA 500 FU impresses with an opening speed of up to 1 m/s, speeding up logistics processes and reducing thermal losses. In addition, the frequency converter control with soft start and soft stop takes the stress off all mechanical door elements, guaranteeing quiet door travel. With the ITO 500 FU operator developed especially for underground garages, the door achieves an opening speed of up to 0.5 m/s.

→ For further information, see from page 80.



NON-CONTACT SAFETY. Efficient monitoring of the closing edge increases safety. The operators WA 500, WA 500 FU and ITO 500 FU optionally come with leading photocell VL1-LE at no surcharge. It responds to movements and obstacles without any contact, reliably stopping the door if necessary.

→ For further information, see from page 92.

Energy-saving detailed solutions

Industrial doors with sections with thermal break and ThermoFrame frame connection offer high thermal insulation and low energy losses. High-quality seals on the side frames and lintel as well as the bottom seal with double chamber as standard reduce air permeability. Further details such as optional ribbing infill, corner seals and lintel counter seal achieve even better air-tightness.

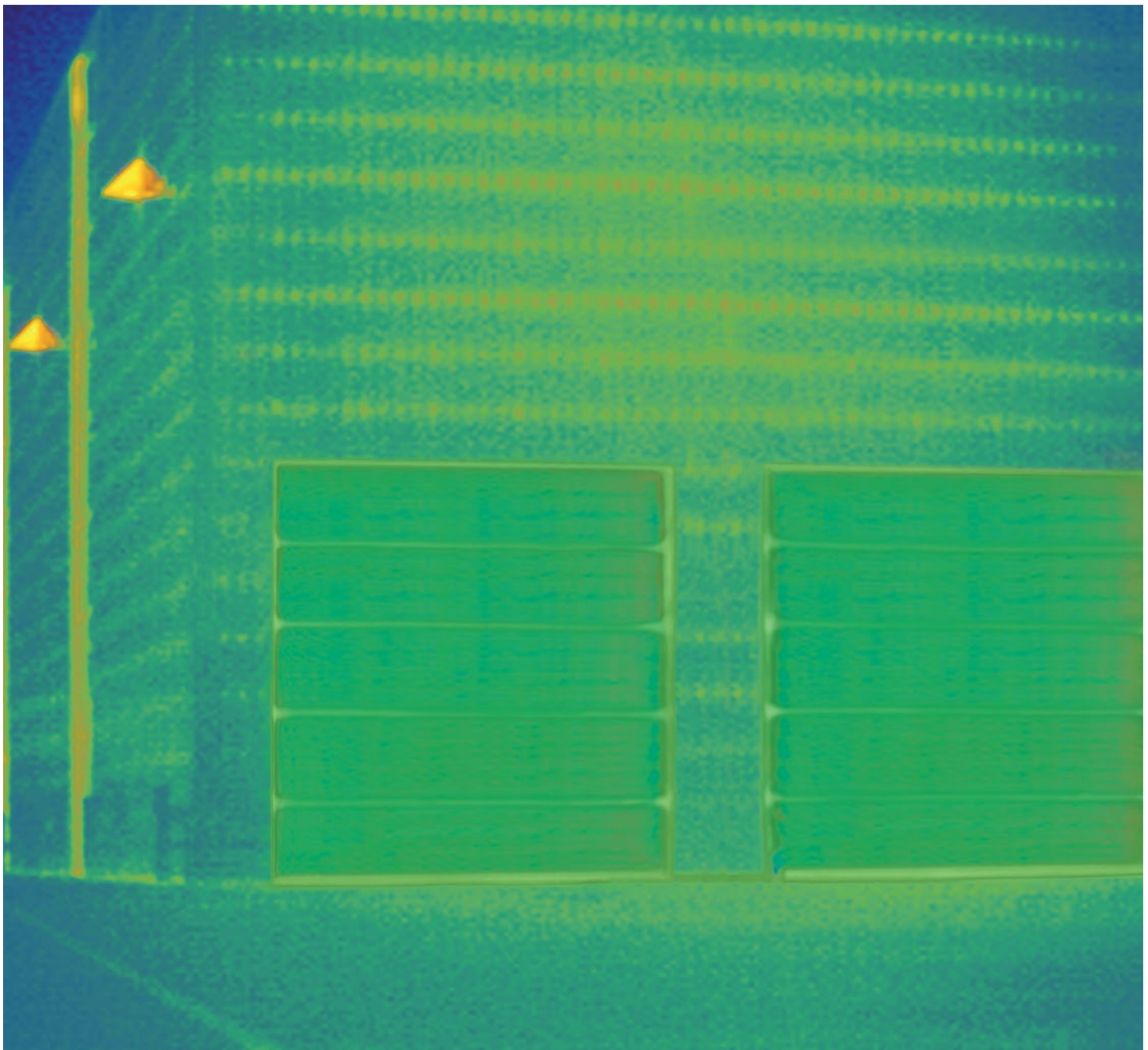

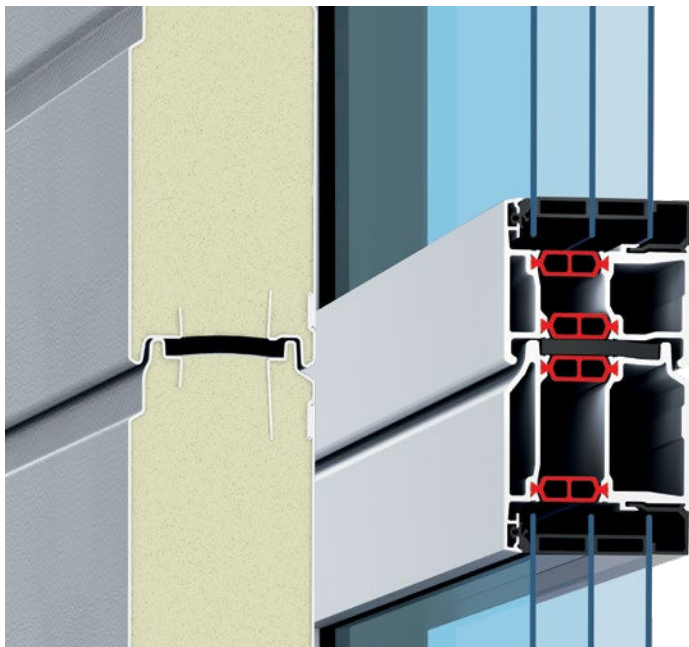

Best thermal insulation

U-value of up to 0.51 W/(m²·K)

ENERGY-SAVING DOORS. The steel sectional doors and aluminium sectional doors with 67 mm depth with thermal break feature excellent thermal insulation, saving you valuable energy costs. With optional quadruple panes or climatic glass, the thermal insulation value can be increased even further.

→ For further information, see from page 40.

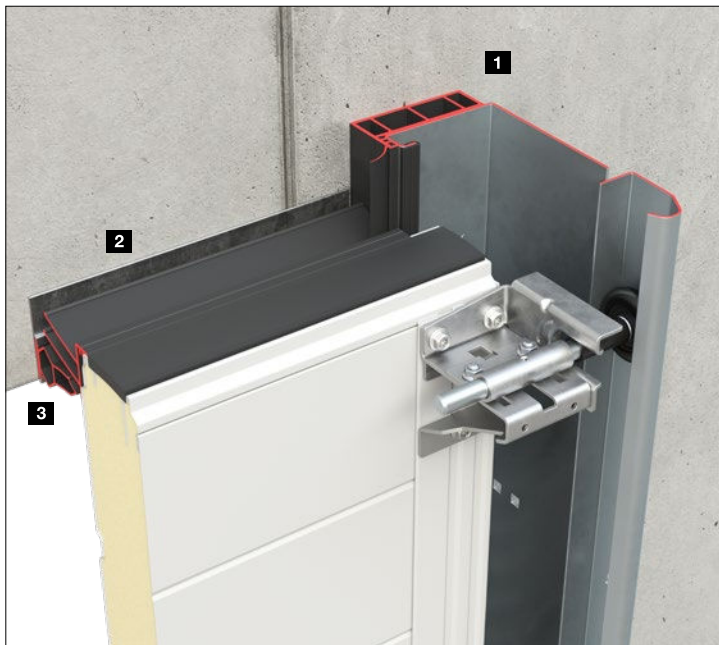

Up to 21%

better thermal insulation¹⁾



Up to class 4

low air permeability²⁾

ENERGY-SAVING EQUIPMENT. The optional ThermoFrame 26 **1** providing support and a thermal break between frame and brickwork as well as double seals on the lintel **2** improve the thermal insulation and air-tightness of your doors. Details such as the additional lintel counter seal **3** and optional infills **4** further reduce energy losses – especially in changing climatic conditions.

→ Further information can be found on page 59.

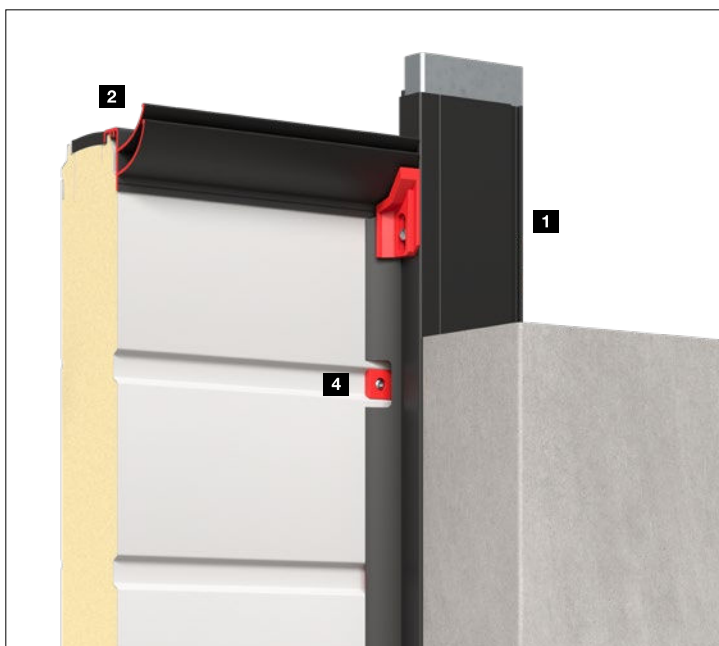

¹⁾ SPU 67 Thermo without glazing with optional ThermoFrame for a door surface of 3000 × 3000 mm

²⁾ SPU 67 Thermo without glazing with optional ThermoFrame and the "increased air-tightness" set

TOP: SPU 67 Thermo (Fig. left) and ALR 67 Thermo (Fig. right)

CENTRE: Viewed from outside

BOTTOM: Viewed from inside

Perfect transparency

Aluminium frame doors lend buildings more light and an elegant appearance. The standard Duratec synthetic glazing offers a permanently clear view, and the matching aluminium profiles convince with a harmonious overall appearance. This also applies to the combination of doors with different depths. This way, your company will always be seen at its best.



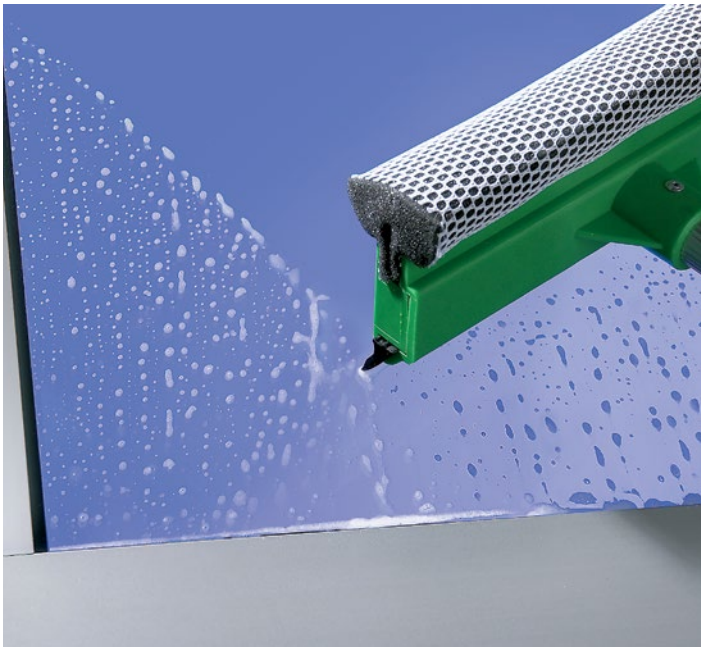

Only from Hörmann
Duratec synthetic glazing



Duratec
Synthetic glazing with maximum
scratch resistance

A PERMANENTLY CLEAR VIEW. A special high-quality coating, similar to that used on car headlights, protects the Duratec synthetic glazing from scratches and damage caused by cleaning over the long term. This preserves the attractive appearance despite heavy use in tough industrial settings. The Duratec glazing is available as standard for all sectional doors with clear synthetic glazing.



Watch the video on YouTube or at
www.hormann.co.uk/media-centre

HARMONIOUS DESIGN. Sectional doors, doors with wicket door, side doors and panels are designed in such a way that all elements present a harmonious overall appearance when fitted in a line of buildings. The rails of the aluminium glazing frames are aligned to match – for both standard profiles and profiles with thermal break, both with depth 42 and depth 67.

Equipment for more security and convenience

We offer you a wide range of optional equipment, allowing you to easily tailor each door to your requirements. For example, a wicket door with trip-free threshold for convenient passage. Optional adjustable rotary latches and shootbolts, including in combination with an exterior handle to securely and conveniently close the door from the outside, or the RC2 security features provide additional security.





Only from Hörmann
Anti-lift kit on both sides



**Anti-lift kit
as standard**



**Optional RC2
security features**
Tested and certified



**Extra-flat
threshold rail**

RELIABLE BREAK-IN RESISTANCE EQUIPMENT.

The standard anti-lift kit functions mechanically and thus effectively protects your goods and machines during power outages. You can optionally equip sectional doors, wicket doors and side doors with proven and certified RC2 security features (for depth 42 mm and 67 mm).

→ Further information can be found on page 75.

SAFE AND CONVENIENT WORK PROCESSES.

The extra-flat stainless steel threshold rail for wicket doors (Fig. left) facilitates work processes and reduces the risk of accidents. It reduces the risk of tripping and makes it considerably easier for slide carriages to pass through. Under certain circumstances, wicket doors with trip-free threshold can even be used as escape doors and unobstructed entrances.

→ For further information, see from page 64.

Individual door solutions

These space-saving door systems can be adapted to different building architectures using various track applications. This gives you planning reliability when building a new facility or renovating. Hörmann offers tailored solutions: special doors for logistics companies, underground garage doors, Vitraplan doors with exclusive glazing or matching facade panels as well as doors integrated in facades with a flush-fitting design.





FULL PASSAGE HEIGHT. With the right door version and size, the low headroom track application with swivel mechanism can achieve the full door height as the clear passage height with just 200 mm of required headroom. This is especially advantageous in underground garages.

SUITABLE FITTING SOLUTIONS. With more than 30 track applications, industrial sectional doors can be optimally matched to the requirements of your building. Detailed solutions such as low-mounted spring shafts or adjustable components additionally facilitate maintenance and make the doors especially service-friendly.

→ For further information, see from page 60.





24

Logistics
Retailers



26

Warehouses
Agricultural buildings



28

Public buildings
Fire brigades



30

Workshops
Car showrooms



32

Collective garages



34

Prestigious buildings
On-site cladding





TOP LEFT. SPU F42 with good thermal insulation for heated buildings

TOP RIGHT. SPU F42 Parcel for loading and unloading lorries and vans at a loading station

BOTTOM LEFT. SPU 67 Thermo in combination with Hörmann loading houses, DOBO dock levellers and inflatable dock seals for use in food and cold logistics

BOTTOM RIGHT. Low-track sectional door SPU F42 in combination with insulated dock levellers and dock seals from Hörmann



Logistics and centres of commerce

Hörmann industrial sectional doors and operators are optimally matched to Hörmann loading technology. You therefore receive a logistics solution that perfectly matches your requirements in terms of thermal efficiency and functions. Double-skinned sectional doors SPU F42 / SPU 67 Thermo are recommended for heated buildings to minimise energy losses as far as possible. SPU F42 / APU F42 Parcel was especially developed for parcel services.

→ For further information on SPU F42 / SPU 67 Thermo, see from page 42.

→ For further information on SPU F42 / APU F42 Parcel, see from page 54.

Warehouses and agricultural buildings

The robust sectional doors are designed for the tough everyday conditions in industrial, commercial and agricultural applications. A wicket door with trip-free threshold provides for easy and safe pedestrian passage, and optional glazings lend the building daylight.

→ For further information about wicket doors with trip-free threshold, see from page 64.





TOP. SPU F42 with wicket door with trip-free threshold for easy pedestrian passage

BOTTOM LEFT. SPU 67 Thermo for large door openings

BOTTOM RIGHT. SPU F42 with ultra-fast door opening of up to 1 m/s with operator WA 500 FU and control 560



Public buildings and fire brigades

Large glazings offer more light in the building and – thanks to Duratec synthetic glazing as standard – a permanently clear view. The PU-foamed steel bottom section of the APU F42 / APU 67 Thermo is cost-effective and resistant to dirt.

→ For further information on APU F42 / APU 67 Thermo, see from page 44.





TOP LEFT. APU 67 Thermo with high thermal insulation and robust steel bottom section

TOP RIGHT. SPU 67 Thermo with aluminium glazing frame

BOTTOM. ALR F42 fully glazed for more light in the building





TOP. ALR 67 Thermo Glazing with real glass panes

BOTTOM LEFT. APU F42 with matching glazing division for doors with wicket door and doors without wicket door

BOTTOM RIGHT. ALR F42 fully glazed for light in the float zone; matching side door NT 60





Workshops and car showrooms

Thanks to large glazings made of real glass, the ALR F42 Glazing becomes a display window, attracting potential customers. The standard Duratec synthetic glazing in the ALR F42 / ALR 67 Thermo ensures a permanently clear view. A wicket door with trip-free threshold offers service-friendly passage.

→ For further information on ALR F42 Glazing / ALR 67 Thermo Glazing, see from page 48.

→ For further information on ALR F42 / ALR 67 Thermo, see from page 46.





TOP LEFT. ALR F42 with on-site grille plates
 TOP RIGHT. ALR F42 with expanded mesh infill
 BOTTOM. ALR F42 with PU sandwich infill

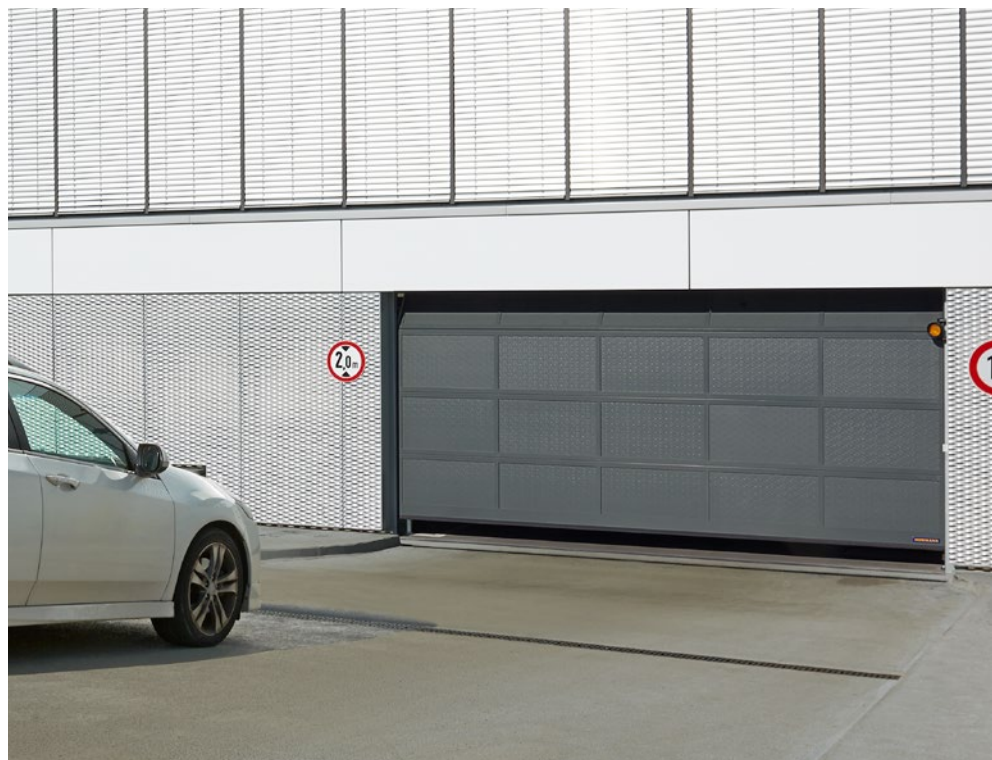



Collective garages

Especially for this purpose, Hörmann offers perfectly matched systems consisting of door, operator and comprehensive accessory programme, which includes everything from posts to warning light systems.

→ You will find more information on operators and accessories from page 78.



Prestigious buildings

Doors with exclusive glazing impress with an engaging mix of reflection and transparency. Matching facade panels can be used for the door surface to create a harmonious overall appearance. Hörmann offers ideal door solutions for sophisticated architecture.

→ For further information on the ALR F42 Vitraplan and ALR F42 Vitraplan AT, see from page 50.





TOP. ALR F42 Vitraplan with grey tinted glazing integrated in the glass facade

BOTTOM LEFT. ALR F42 Vitraplan with modern ALUCOBOND® naturAL Reflect 405 facade panels

BOTTOM RIGHT. ALR F42 Vitraplan with grey tinted glazing

On-site cladding

Design your sectional door according to your wishes with timber, metal, ceramics, plastic and many other materials. The industrial sectional door ALR F42 with aluminium frame construction and PU sandwich infill forms the basis for the facade cladding.

→ For further information on the ALR F42 for on-site cladding, see from page 52.





TOP RIGHT. ALR F42 with on-site flush-fitting cladding made of laminated material board

BOTTOM. ALR F42 with on-site flush-fitting cladding made of aluminium composite panels





40



70



78



Versions Accessories Technology

- 40 Section and frame versions
- 42 Double-skinned steel sectional doors
- 44 Glazed aluminium sectional doors with steel bottom section
- 46 Glazed aluminium sectional doors
- 48 Aluminium sectional doors with extensive glazing
- 50 Aluminium sectional doors for sophisticated architecture
- 52 Aluminium sectional doors for on-site cladding
- 54 Logistics doors
- 56 Equipment
- 64 Wicket doors with trip-free threshold
- 68 Side doors
- 70 Individual colour schemes
- 72 Glazings and infills
- 75 Security features
- 77 Operation options for manually operated doors
- 78 Operators and controls
- 104 Technical data

Section and frame versions

Overview

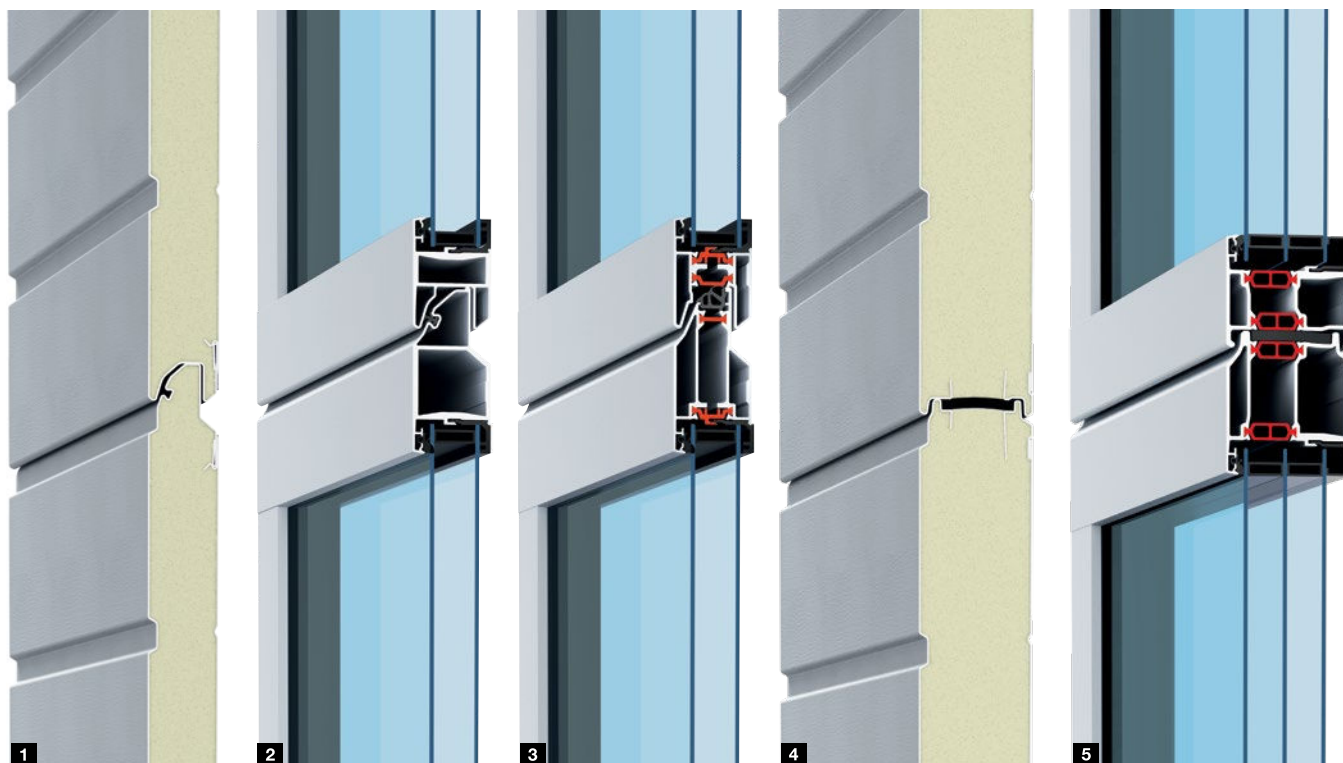

42 mm depth

The steel sections **1** and aluminium frame **2** are designed for the tough everyday conditions in industrial and commercial applications and offer good thermal insulation. In case of higher thermal insulation and maximum transparency requirements, we recommend doors with an aluminium frame with thermal break **3**.

67 mm depth

The standard steel sections with thermal break **4** and aluminium frame **5** feature an excellent thermal insulation of up to $0.51 \text{ W}/(\text{m}^2\cdot\text{K})$ in the SPU 67 Thermo and enable door sizes of up to 10 m in width. The thermal break between the exterior and interior also reduces the accumulation of condensation water on the inside of the door.



Matching appearance
In both depths

The two depths can be combined depending on the requirements in the project, as the door has a fully matching appearance.

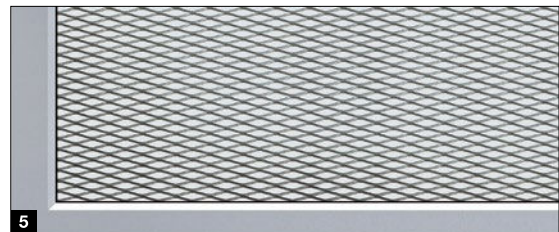
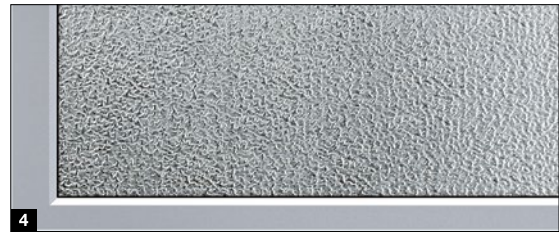
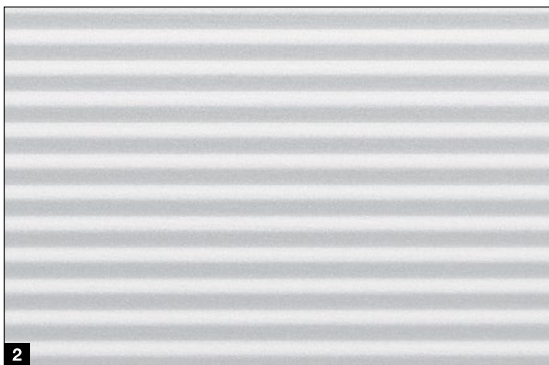

Steel sections

The double-skinned, PU-foamed sections are especially robust and, thanks to a hot-galvanized steel surface with high-quality coating (2C PUR), are optimally protected against adverse weather effects. They are used in steel sectional doors and glazed aluminium frame doors with steel bottom section.

1 The resistant Stucco surface finish offers uniform ribbing every 125 mm in the section and in the section transition. Minor scratches and traces of dirt are harder to notice on this surface finish.

2 The elegant Micrograin surface finish is smooth and features a characteristic fine line pattern. This surface finish harmonises especially well with modern facades that are characterised by their clear design.

The inside of the door is Stucco-textured in Grey white, RAL 9002.

Aluminium frame

The aluminium frames are made of high-quality extruded profiles. They are used in glazed aluminium frame doors and as a glazing element in steel sectional doors.

Glazing **3**

The standard double (with 42 mm depth) or triple (with 67 mm depth) Duratec synthetic glazing offers maximum scratch resistance and good thermal insulation. In case of higher thermal insulation requirements, we recommend quadruple glazings or climatic double panes.

Panels **4**

The double-skinned panels are ideal as a robust bottom profile in glazed frame doors.

Mesh infills **5**

For collective garages, expanded meshes or perforated sheet infills provide optimal ventilation.

→ For further information, see from page 72.

Double-skinned steel sectional doors

SPU F42 / SPU 67 Thermo



Matching appearance

In both depths

- Robust PU-foamed steel sections
- Optionally with Stucco **1** or Micrograin **2** surface finish
- Optional section window or aluminium glazing frame
- Good thermal insulation with SPU F42
- Optimum thermal insulation with SPU 67 Thermo with sections with thermal break



Door type

SPU F42

SPU 67 Thermo

	Without wicket door	With wicket door	Without wicket door	With wicket door
Door size				
Max. width (mm)	8000	7000	10000	7000
Max. height (mm)	7500	7500	7500	7500
Construction				
Depth (mm)	42	42	67	67
Steel sections	●	●	●	●
Aluminium frame	○	○	○	○
With thermal break	-	-	●	●
Thermal insulation EN 13241, Appendix B EN 12428 U-value in W/(m ² ·K) for a door surface of 5000 × 5000 mm				
Closed sectional door	1,0	1,2	0,62	0,82
With ThermoFrame	0,94	1,2	0,51	0,75
Section	0,50	0,50	0,33	0,33

- = As standard
- = Optionally as glazing
- = Not available

Example door versions

Door width up to 4500 mm (Example 4500 × 4500 mm)

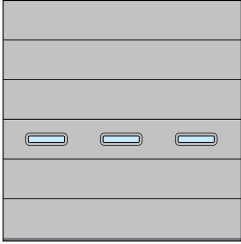

SPU F42, SPU 67 Thermo
NEW. Section window type F (RC2 door version available), uniform field division

Door width up to 5500 mm (Example 5500 × 4500 mm)

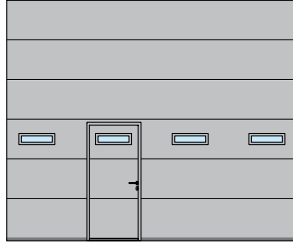

SPU F42, SPU 67 Thermo
Section window type D
Wicket door arrangement on the left

Door width over 5500 mm (Example 7000 × 4500 mm)

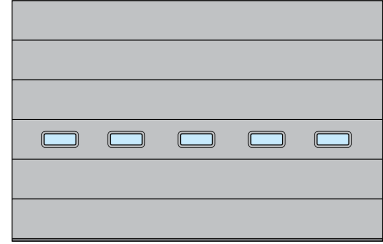

SPU F42, SPU 67 Thermo
Section window type A

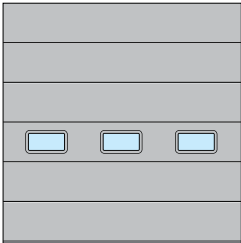

SPU F42, SPU 67 Thermo
Section window type E
Uniform field division

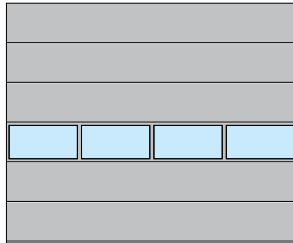

SPU F42, SPU 67 Thermo
Aluminium glazing frame
Uniform field division

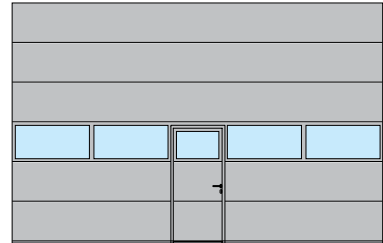

SPU F42, SPU 67 Thermo
Aluminium glazing frame
Wicket door arrangement in the centre

Note

On request, the SPU F42 Plus is available in various door styles and surface finishes as Hörmann sectional garage doors.

Clear passage width (LDB), wicket door
SPU F42: 940 mm
SPU 67 Thermo: 905 mm

Tip

Efficient thermal insulation

With a U-value of up to 0.51 W/(m²·K)

Well-insulated industrial sectional doors are essential in heated buildings to keep energy losses at a minimum. Hörmann industrial sectional doors with 67 mm thick sections with thermal break offer very effective insulation and thus save energy costs. You can additionally obtain up to 21% better thermal insulation with the optional ThermoFrame 26 providing support and a thermal break between frame and brickwork. The lintel seal and lintel counter seal achieve even better thermal insulation and air-tightness of your doors.

→ Further information can be found on page 59.



Glazed aluminium sectional doors with bottom section

APU F42, APU F42 Thermo, APU 67 Thermo



Matching appearance

In both depths



Duratec

Synthetic glazing with maximum scratch resistance

- Extensive aluminium glazing frame
- Robust PU-foamed steel bottom section
- Good thermal insulation with APU F42
- Excellent thermal insulation with APU F42 Thermo with sections with thermal break
- Optimum thermal insulation with APU 67 Thermo with sections with thermal break

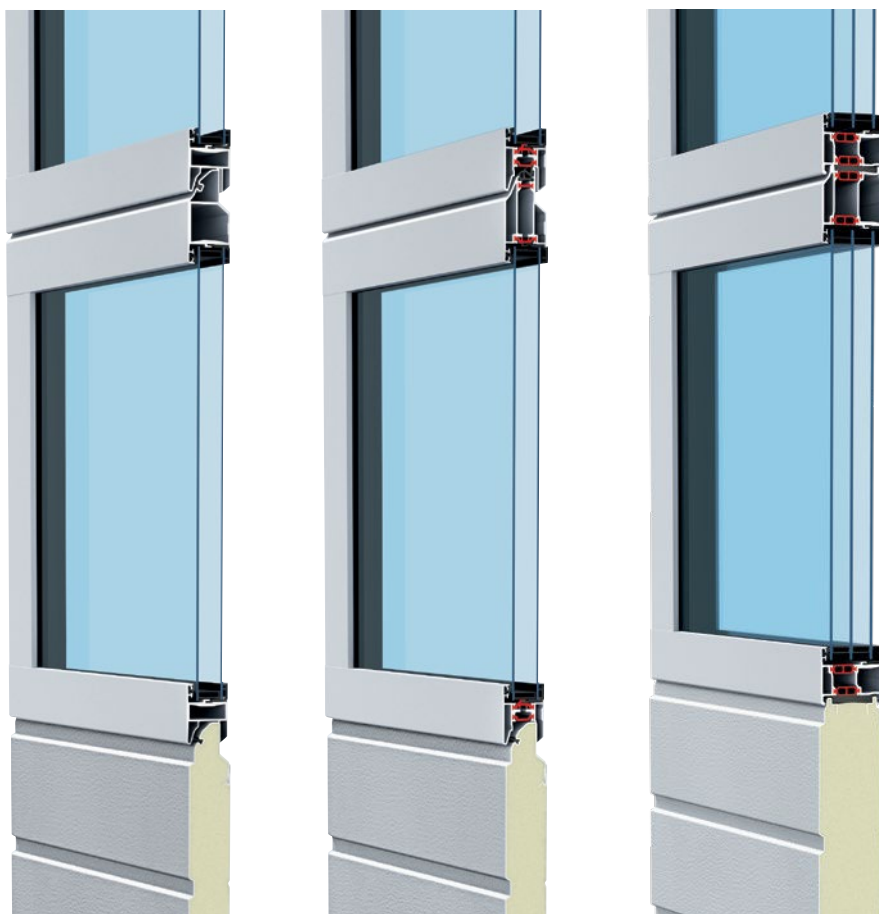

Door type	APU F42		APU F42 Thermo		APU 67 Thermo	
	Without wicket door	With wicket door	Without wicket door	With wicket door	Without wicket door	With wicket door
Door size						
Max. width (mm)	8000	7000	7000	7000	10000	7000
Max. height (mm)	7500	7500	7500	7500	7500	7500

Construction

Depth (mm)	42	42	42	42	67	67
Steel sections	■	■	■	■	■	■
Aluminium frame	●	●	●	●	●	●
With thermal break	-	-	●	●	●	●

Thermal insulation EN 13241, Appendix B EN 12428

U-value in W/(m²·K) for a door surface of 5000 × 5000 mm

Standard double pane	3,4	3,6	2,9	3,1	-	-
With ThermoFrame	3,3	3,6	2,8	3,1	-	-
Standard triple pane	-	-	-	-	2,1	2,3
With ThermoFrame	-	-	-	-	2,0	2,2
Optional double climatic pane, single-pane safety glass	2,5	2,7	2,0	2,2	1,6	1,8
With ThermoFrame	2,4	2,6	1,9	2,1	1,5	1,7

● = As standard

■ = As floor section as standard

- = Not available

Example door versions

Door width up to 4500 mm
(Example 4500 × 4500 mm)

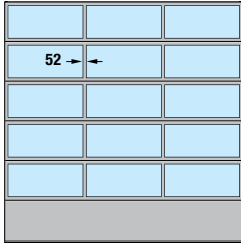

APU F42, APU F42 Thermo, APU 67 Thermo
Uniform field division

Door width up to 5500 mm
(Example 5500 × 4500 mm)

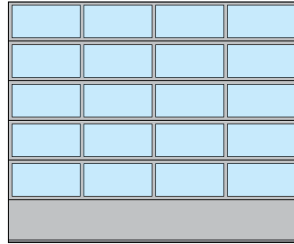

APU F42, APU F42 Thermo, APU 67 Thermo
Uniform field division

Door width over 5500 mm
(Example 7000 × 4500 mm)

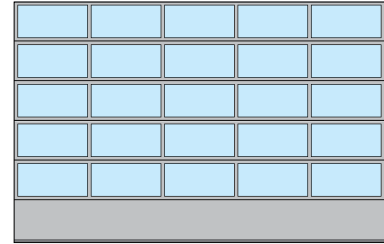

APU F42, APU F42 Thermo, APU 67 Thermo
Uniform field division

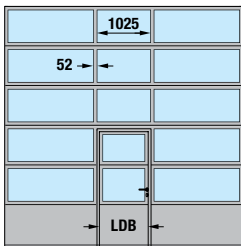

APU F42, APU F42 Thermo, APU 67 Thermo
Wicket door arrangement in the centre

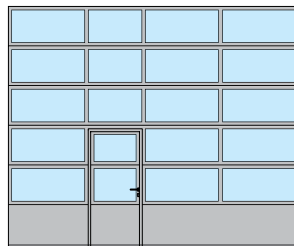

APU F42, APU F42 Thermo, APU 67 Thermo
Wicket door arrangement on the left

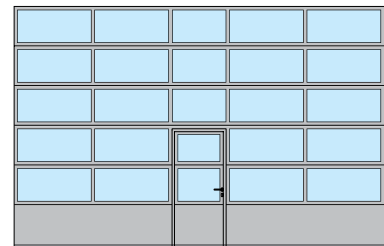

APU F42, APU F42 Thermo, APU 67 Thermo
Wicket door arrangement in the centre

Note

On request, uniform field division is also possible with wicket door. The field division of the wicket door arrangement is also available for sectional doors without wicket door. For modernisation or when the matching appearance of the existing sectional doors must be ensured, the APU F42 and APU F42 Thermo are also available with 91 mm wide rails.

Clear passage width (LDB), wicket door
APU F42, APU F42 Thermo: 940 mm
APU 67 Thermo: 905 mm

Especially easy to service and repair

Thanks to uniform PU foaming, the 750 mm high steel bottom section is especially robust, available in either Stucco **1** or Micrograin **2** surface finishes. In case of extensive damage, it can be exchanged easily and inexpensively.

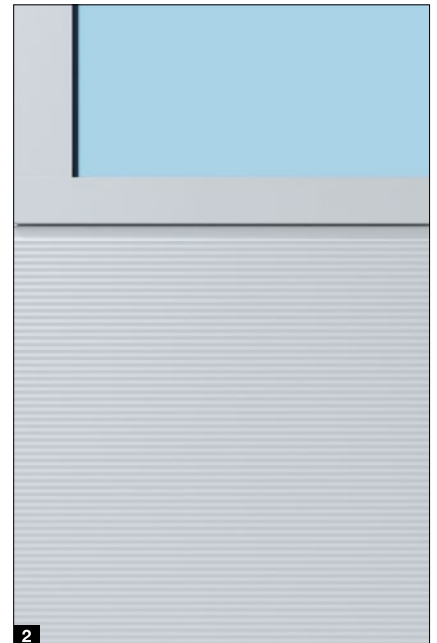
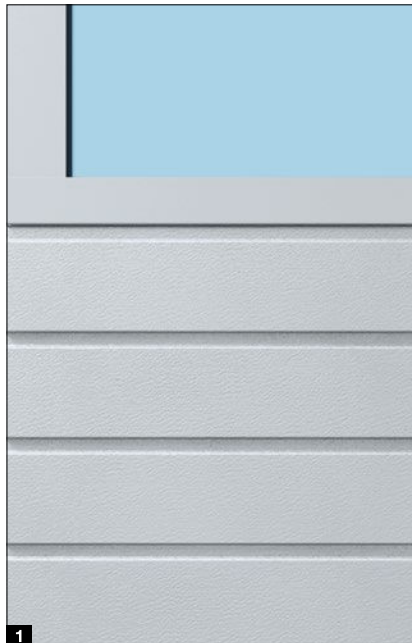

Glazed aluminium sectional doors

ALR F42, ALR F42 Thermo, ALR 67 Thermo



Matching appearance

In both depths



Duratec

Synthetic glazing with maximum scratch resistance

- Extensive aluminium glazing frame
- Good thermal insulation with ALR F42
- Excellent thermal insulation with ALR F42 Thermo with sections with thermal break
- Optimum thermal insulation with ALR 67 Thermo with sections with thermal break

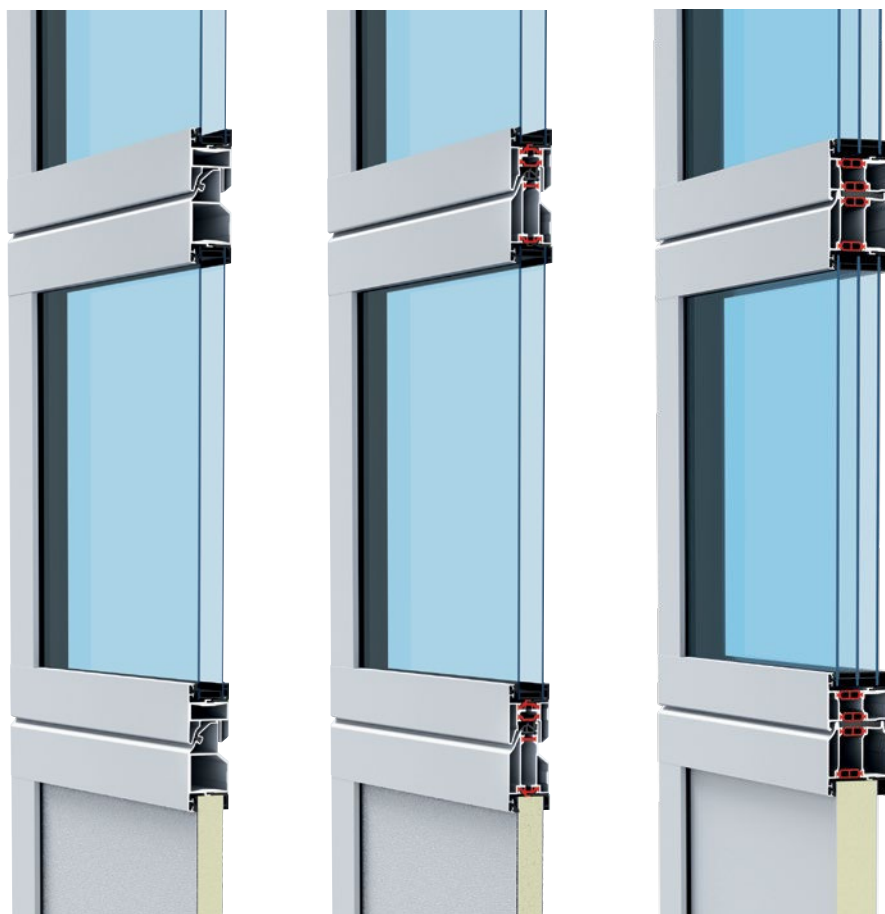

Door type

ALR F42

ALR F42 Thermo

ALR 67 Thermo

	ALR F42		ALR F42 Thermo		ALR 67 Thermo	
	Without wicket door	With wicket door	Without wicket door	With wicket door	Without wicket door	With wicket door
Door size						
Max. width (mm)	8000	7000	7000	7000	10000	7000
Max. height (mm)	7500	7500	7500	7500	7500	7500

Construction

Depth (mm)	42	42	42	42	67	67
Steel sections	-	-	-	-	-	-
Aluminium frame	●	●	●	●	●	●
With thermal break	-	-	●	●	●	●

Thermal insulation EN 13241, Appendix B EN 12428

U-value in W/(m²·K) for a door surface of 5000 × 5000 mm

Standard double pane	3,6	3,8	3,0	3,2	-	-
With ThermoFrame	3,6	3,8	3,0	3,2	-	-
Standard triple pane	-	-	-	-	2,2	2,4
With ThermoFrame	-	-	-	-	2,1	2,3
Optional double climatic pane, single-pane safety glass	2,7	2,9	2,1	2,3	1,7	1,9
With ThermoFrame	2,6	2,8	2,0	2,2	1,6	1,8

- = As standard
- = Not available

Example door versions

Door width up to 4500 mm (Example 4500 × 4500 mm)

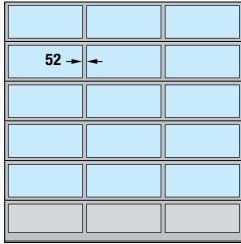

ALR F42, ALR F42 Thermo, ALR 67 Thermo
Uniform field division

Door width up to 5500 mm (Example 5500 × 4500 mm)

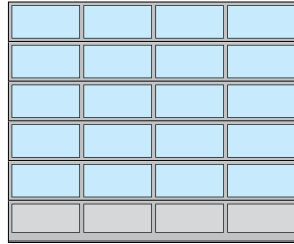

ALR F42, ALR F42 Thermo, ALR 67 Thermo
Uniform field division

Door width over 5500 mm (Example 7000 × 4500 mm)

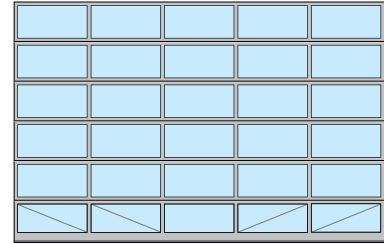

ALR F42, ALR F42 Thermo, ALR 67 Thermo
Uniform field division, fully glazed

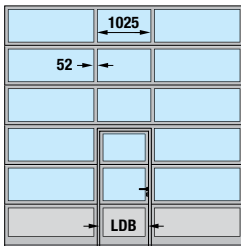

ALR F42, ALR F42 Thermo, ALR 67 Thermo
Wicket door arrangement in the centre

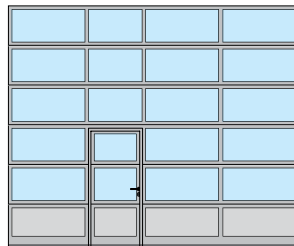

ALR F42, ALR F42 Thermo, ALR 67 Thermo
Wicket door arrangement on the left

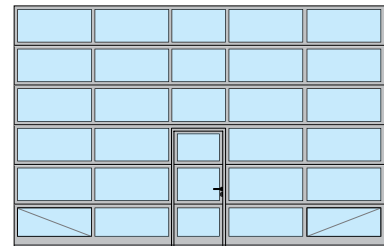

ALR F42, ALR F42 Thermo, ALR 67 Thermo
Wicket door arrangement in the centre, fully glazed

Note

On request, uniform field division is also possible with wicket door. The field division of the wicket door arrangement is also available for doors without wicket door. For modernisation or when the matching appearance of the existing sectional doors must be ensured, the ALR F42 / ALR F42 Thermo are also available with 91 mm wide rails. Of course, individual arrangements of the glass and panel infills or full glazing are also possible.

For better stability, the lower window sections on the inside of doors with full glazing (from 5510 mm door width) and doors with real glass and wicket door (from 4510 mm door width) are equipped with diagonal structural cross struts.

Clear passage width (LDB), wicket door
ALR F42, ALR F42 Thermo: 940 mm
ALR 67 Thermo: 905 mm

Optional infills

We deliver the bottom door section as standard with PU sandwich infill, both sides Stucco-textured. Optionally, the door is available fully glazed for maximum transparency without surcharge. Additional glazing variants, sandwich infills and ventilation grilles are available depending on your requirements.

→ For further information, see from page 72.

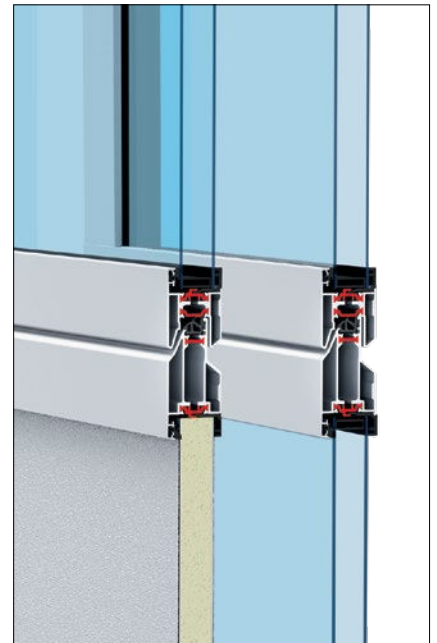

Aluminium sectional doors with extensive glazing

ALR F42 Glazing, ALR 67 Thermo Glazing



Matching appearance

In both depths



Real glass

- Display window door for an unimpeded view into showrooms
- Continuous window sections, without vertical rails up to 3330 mm door width
- Window sections with exact, uniform division
- Good thermal insulation with ALR F42 Glazing
- Optimum thermal insulation with ALR 67 Thermo with aluminium glazing frame with thermal break



Door type	ALR F42 Glazing	ALR F67 Thermo Glazing
-----------	-----------------	------------------------

Door size

Max. width (mm)	5500	5500
Max. height (mm)	4000	4000

Construction

Depth (mm)	42	67
Steel sections	-	-
Aluminium frame	●	●
With thermal break	-	●

Thermal insulation EN 13241, Appendix B EN 12428

U-value in W/(m²·K) for a door surface of 5000 × 5000 mm

Standard single pane, laminated safety glass	6,1	-
Standard double pane, single-pane safety glass	-	3,0
With ThermoFrame	-	2,9
Optional double climatic pane, single-pane safety glass	2,7	1,8
With ThermoFrame	2,6	1,7

- = As standard
- = Not available

Example door versions

Door width up to 3330 mm
(Example 3300 × 3500 mm)

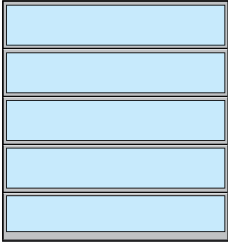

ALR F42 Glazing, ALR 67 Thermo Glazing

Door width over 3330 mm
(Example 4500 × 3500 mm)

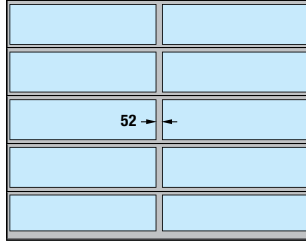

ALR F42 Glazing, ALR 67 Thermo Glazing
with vertical rail

Note

For modernisation or when the matching appearance of the existing sectional doors must be ensured, the ALR F42 Glazing is also available with 91 mm wide rails.

Tip

Efficient thermal insulation

With a U-value of up to 1.7 W/(m²·K)

Heated sales areas

The ALR 67 Thermo Glazing has a thermal break and offers optimal thermal insulation with maximum transparency. Optional climatic glazing and ThermoFrame decrease the thermal insulation value to a maximum of 1.7 W/(m²·K). This helps you save valuable energy.

→ For further information, see from page 72.

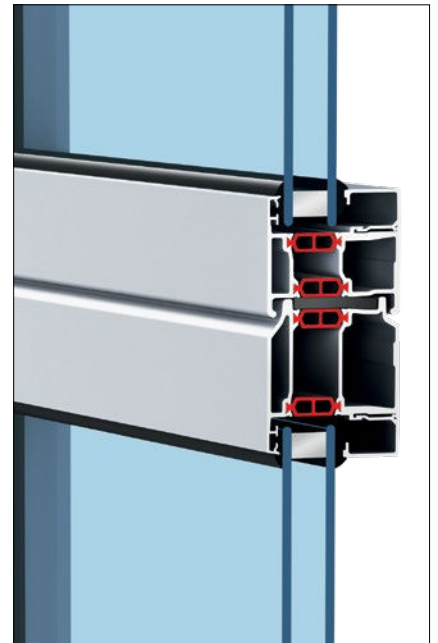

Aluminium sectional doors for sophisticated architecture

ALR F42 Vitraplan, ALR F42 Vitraplan AT



Duratec

Synthetic glazing with maximum scratch resistance (ALR F42 Vitraplan)

- Extremely elegant overall appearance with surface-mounted, flush-fitting glazing or facade panels
- Concealed frame profiles in matching colour
- Eye-catching element on modern industrial structures and prestigious private buildings
- Grey tinted glazing for an engaging mix of reflection and transparency with ALR F42 Vitraplan
- Modern facade panels for a harmonious appearance with ALR F42 Vitraplan AT

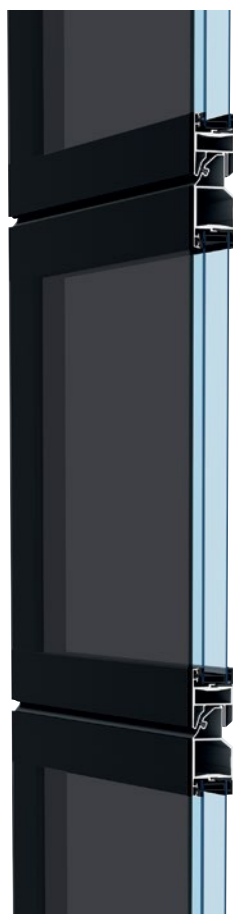

Door type	ALR F42 Vitraplan	ALR F42 Vitraplan AT
-----------	-------------------	----------------------

Door size

Max. width (mm)	6000	6000
Max. height (mm)	7500	7500

Construction

Depth (mm)	42	42
Steel sections	-	-
Aluminium frame	●	●
With thermal break	-	-

Thermal insulation EN 13241, Appendix B EN 12428

U-value in W/(m²·K) for a door surface of 5000 × 5000 mm

Standard double pane	3,2	
With ThermoFrame	3,2	
Optional triple pane	3,1	
With ThermoFrame	3,1	
PU sandwich infill		2,6
With ThermoFrame		2,6

- = As standard
- = Not available

Example door versions

Door width up to 4500 mm
(Example 4500 × 4500 mm)

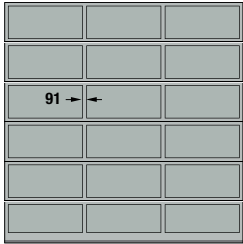

ALR F42 Vitraplan
Uniform field division

Door width over 4500 mm
(Example 5500 × 4500 mm)

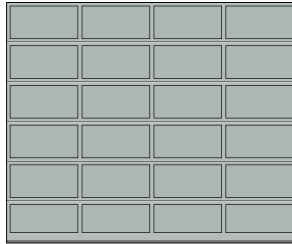

ALR F42 Vitraplan
Uniform field division

Glazing / facade panels

Duratec

ALUCOBOND®

TRESPA®

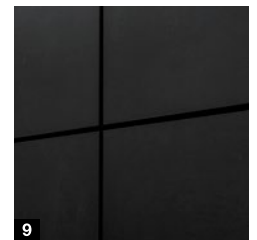
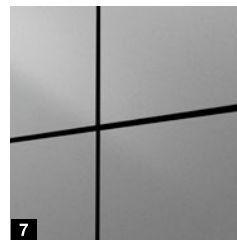
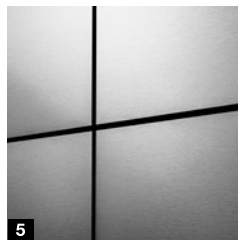
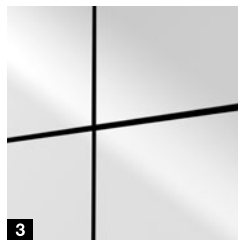
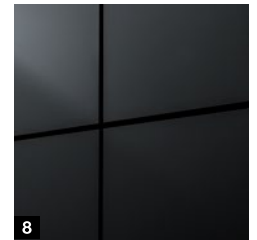
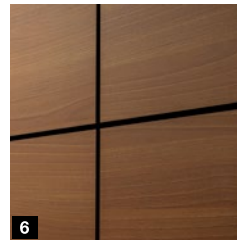
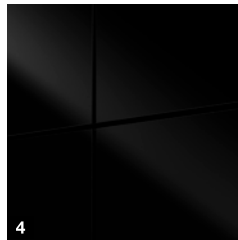

Duratec glazing

- 1 Grey tinted

ALUCOBOND® facade panels

- 2 naturAL Reflect 405*
- 3 Solid Colours Pure White 10 / 100
- 4 Solid Colours Black 326
- 5 naturAL Brushed 400

For further information, see www.alucobond.com

TRESPA® METEON® facade panels

- 6 Italian Walnut NW08 Matt
- 7 Paris Silver LM 5101 Diffuse
- 8 Anthracite Grey A25.8.1 Satin
- 9 Natural Slate NA18 Matt

For further information, see www.trespa.com

* The ALUCOBOND® panel naturAL Reflect 405 is high-gloss aluminium with a transparent protective coating. The metallic gloss gives objects an elegant and lively appearance. Naturally, reflections may occur, which must be taken into account in the planning on site. As an alternative, the surface finish naturAL Brushed 400 can be selected, which prevents possible disturbing reflections due to its surface texture.

Aluminium sectional doors for on-site cladding

ALR F42



On-site cladding

- Frame profiles with PU sandwich infill
- With horizontal profiles for cladding fitting
- For flush-fitting cladding made of timber, metal and many other materials



ALR F42

The facade cladding door base consists of frame profiles with PU sandwich infill. The horizontal profiles are cladded. Optionally, we provide vertical fitting profiles to which the facade material can be attached simply and unseen. You can design the on-site, flush-fitting facade cladding to suit your requirements with timber, metal, ceramics, plastic and many other materials. Please observe the maximum weight per unit area of the on-site cladding.

→ For more information, refer to the planning aids.



Flush-fitting facade door



Flush-fitting facade door with base construction

Door type

ALR F42

Door size

Depending on the weight of the on-site cladding

Max. width (mm)	7000
Max. height (mm)	4500

Construction

Depth (mm)	42
Steel sections	-
Aluminium frame	●
With thermal break	-

Thermal insulation EN 13241, Appendix B EN 12428

U-value in W/(m²·K) for a door surface of 5000 × 5000 mm

PU sandwich infill	2,6
--------------------	-----

- = As standard
- = Not available

Excerpt from the planning aid

Standard fitting in the opening

Standard version

- Horizontal view – door frame connection to the facade wall **1**
- Vertical view of the section transitions **2**

Version with fitting profiles

- Horizontal view – door frame connection to the facade wall **3**
- Vertical view of the section transitions **4**

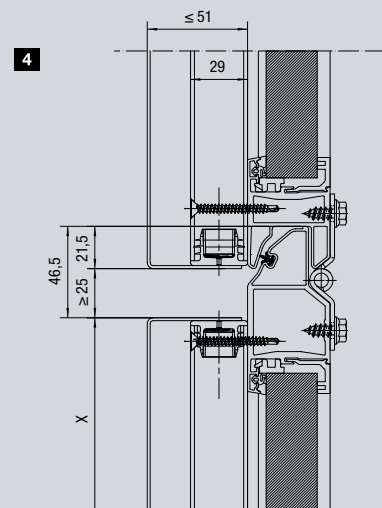
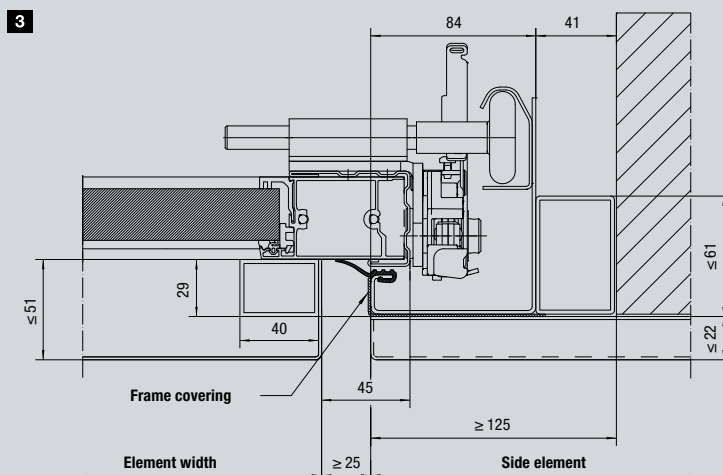
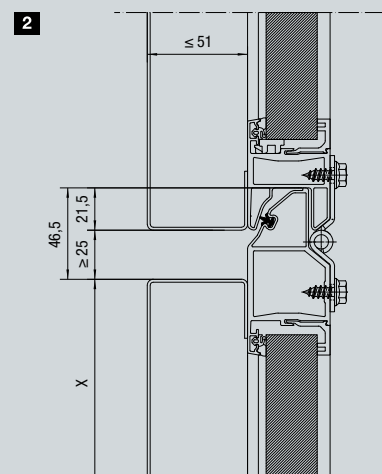
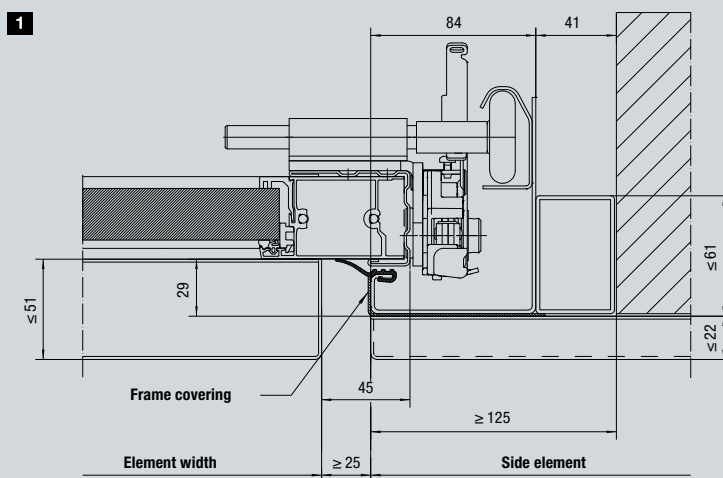

Logistics doors

SPU F42 Parcel / APU F42 Parcel

- Robust PU-foamed steel sections with good thermal insulation in the SPU F42 Parcel
- Combinations of extensive aluminium glazing frame and robust PU-foamed steel bottom sections in APU F42 Parcel



Door type	SPU F42 Parcel	APU F42 Parcel
Door size incl. bottom section		
Width LZ (mm)	1500 – 3000	1500 – 3000
Height RM (mm)	3125 – 4250	3125 – 4250
Bottom section height SLH (mm)	500 – 1450	500 – 1450
Opening height (mm)	2575 – 3700	2575 – 3700
Construction		
Depth (mm)	42	42
Steel sections	●	■
Aluminium frame	○	●
With thermal break	–	–
Closed sectional door	1,0	–
Standard double pane	–	3,4
Track application versions	Track application HP, track application VP	
Door operation	Operator WA 300 S4 (press-and-hold control) and push button DTH-R	
Options	Shootbolt for use as night door rotary latch	

- = As standard
- = Bottom floor section
- = Optional glazing element
- = Not available

SPU F42 Parcel / APU F42 Parcel

Divisible industrial doors

In parcel service logistics centres or warehouses, different loading sites were previously required to load and unload lorries or swap containers and delivery vans at various other loading sites.

The loading surface heights for vans are, at 55 cm, much lower than those for lorries and swap containers, which are approx. 1.35 m.

With the industrial door Parcel, both types of vehicles can be loaded and unloaded at one loading site. For loading lorries or swap containers, the steel bottom section is disconnected from the door and only the top part of the door is opened **1**. When loading vans, the steel bottom section is coupled with the door and remains in the top part of the opening when the door is open **2**.

Advantages through the dual use of the loading site:

- Reduced costs for e.g. conveyor belts, loading sites
- Lower manpower costs due to fewer loading sites
- More efficient loading site utilisation through dual use

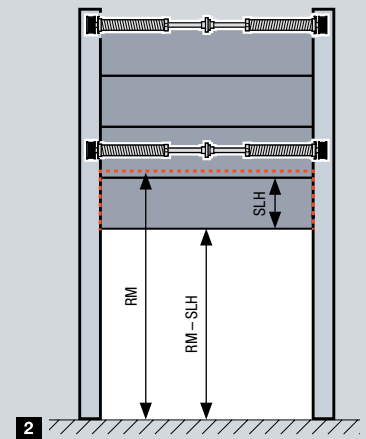
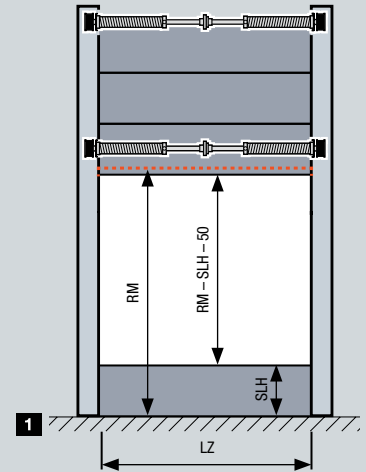

Variable door opening

Both door segments are counterbalanced by separate springs and can therefore be moved separately. The power limit of the WA 300 S4 effectively protects against damage from possible obstructions.



Safe and convenient operation

The door is operated using a DTH-R push button (press-and-hold operation). Glazing in the door allows you to check whether it is safe to open.



Easy decoupling

Releasing the espagnolette lock decouples the lower segment.

Innovative construction

For long-lasting door function





Only from Hörmann

- **ONLY FROM HÖRMANN.** Large double radii **1** for quiet, low-wear door travel
- **ONLY FROM HÖRMANN.** Twin rollers **2** on the top section for especially quiet door closing
- Adjustable plastic rollers with ball-bearing for precise door travel
- Optional 2-component rollers to reduce travel noises by up to 5 dB(A) **3**
- **ONLY FROM HÖRMANN.** Optional plastic frame shoe **4** prevents rust as a result of waterlogging on the door frame
- Double bottom seal with double chamber to improve bottom and side closure
- Upper frame end with connecting bracket **5** for easy fitting of the entire spring shaft
- Secure connection as one piece from the spring shaft to the cable drum **6** for reliable functioning
- Optimised centre hinges made of galvanized steel **7** to connect the individual door sections
- Fitting-friendly roller brackets **8** and roller holders on robust end caps ensure reliable connection of the rollers to the track.

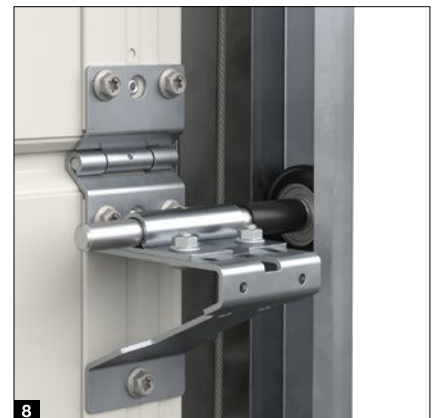

Certified security

For secure door function



Tested and certified

Hörmann industrial sectional doors comply with the safety regulations of European standard 13241. Have this confirmed by other manufacturers.

- A secure door guide prevents the rollers from jumping out of the track **1**
- Easy door opening and closing of the door thanks to optimal counterbalance
- Catch safety device **2** (depending on equipment) provides protection in case a cable or spring breaks
.EUROPEAN PATENT
- Spring safety device (depending on equipment) stops the torsion spring shaft if a spring breaks and securely holds the door in position **.EUROPEAN PATENT**
- Finger trap protection on doors with a depth of 42 mm eliminates trap points on the inside and outside
- Internally guided cables prevent trapping on the cable **3**
- Side trap guard thanks to side frames closed completely from top to bottom
- Safety edge in operators WA 500, WA 500 FU / ITO 500 FU as well as automatic safety cut-out in operators WA 300 S4 and SupraMatic HT stop the door in the event of danger



Optional energy-saving equipment

For efficient thermal insulation and sealing

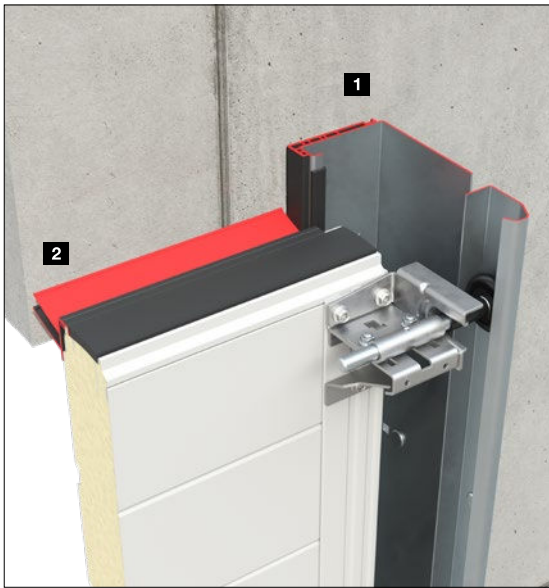

Up to 21%

better thermal insulation¹⁾

ThermoFrame 6

- 6 mm thick thermal break between the frame and brickwork **1**
- Additional seals for improved tightness **2**
- Easy to fit together with the door frame
- Optimum corrosion protection of the side frame
- **Up to 21% improved thermal insulation²⁾**

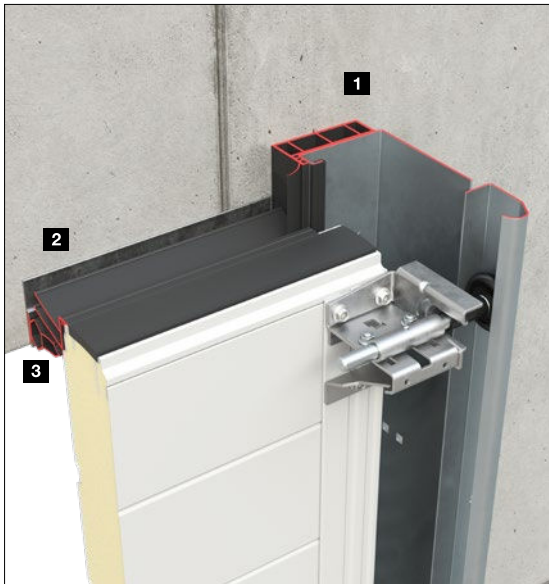

NEW. ThermoFrame 26

- Larger distance to the outer wall through 26 mm thick thermal break between the frame and brickwork **1**
- Minimisation of energy losses caused by deflection of the section due to direct sunlight on dark colours, thanks to overlapping lintel **2** and additional lintel counter seal **3**
- Easy to fit together with the door frame
- Optimum corrosion protection of the side frame
- **Up to 21% improved thermal insulation²⁾**



Up to class 4

low air permeability²⁾



Increased air tightness to reduce energy losses

- Improved standard bottom seal with additional chambers seals effectively to the side seal
- Optional corner seals **4** increase the tightness at the transition between door frame and lintel
- Optional infills **5** seal the ribbing and transitions in the sections

¹⁾ SPU 67 Thermo without glazing with optional ThermoFrame for a door surface of 3000 × 3000 mm

²⁾ SPU 67 Thermo without glazing with optional ThermoFrame and the "increased air-tightness" set

Fitting advantages

For simple, precise fitting

- Precisely fitting connection of track and radius through transition sleeves **1**
- Faster fitting thanks to fewer components and press-fitted bolts **2**
- Ceiling anchor with perforation in two rows for simple fitting
- Suspension material as L-bracket with continuous perforation (can be shortened) for easy fitting
- Fewer suspension points with optional C-rail **3**
- Diagonal fixing **4** of the top track without ceiling suspension
- Recess at the frame shoe **5** facilitates work if the floor is not yet finished
- Flexible shaft coupling to compensate for minor deviations in alignment
- Bolted tracks for simple, cost-effective exchange in the event of impact damage in the frame area
- Connection bracket for shaft holder **6** for easy torsion spring fitting by just one person
- Spring tensioner **7** for easy tensioning of the torsion spring with the aid of an electric screwdriver

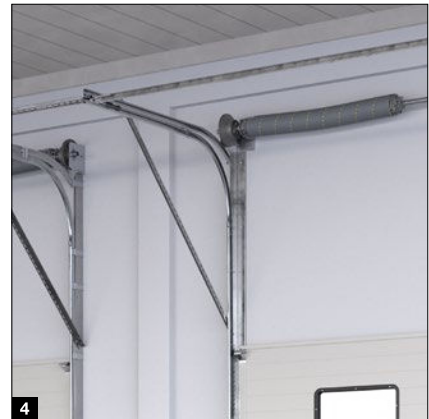

Track versions

Sound planning for old and new buildings

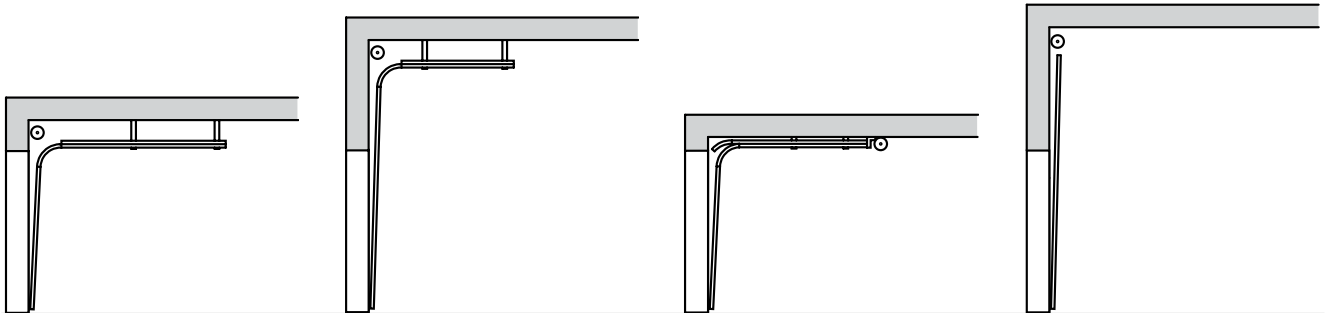

Track application N
Normal track application

Track application H
High-lift track application

Track application L
Low headroom track application

Track application V
Vertical track application

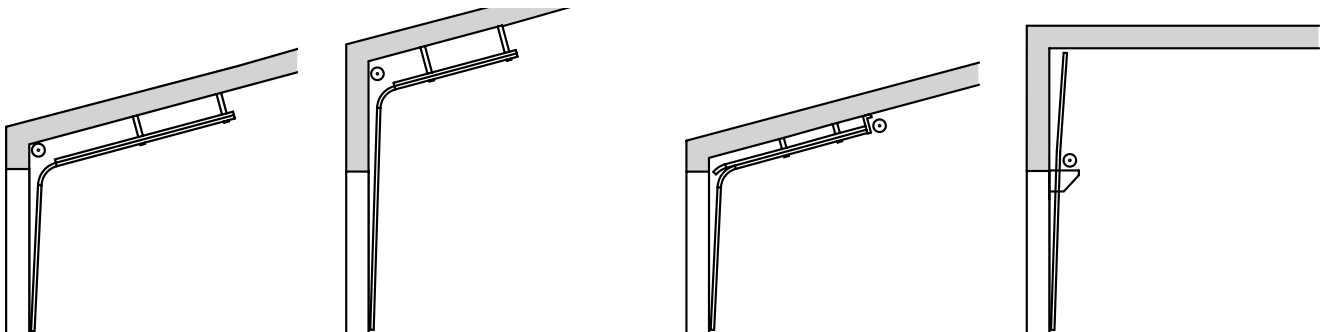

Track application ND
With inclination

Track application HD
With inclination

Track application LD
With inclination

Track application VU
With low-mounted spring shaft



For more information on doors with 42 mm depth, consult the technical manual.



For more information on doors with 67 mm depth, consult the technical manual.

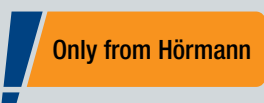

Low headroom track application

Operator and chain are directly on the door. An unsightly and potentially hazardous chain no longer dangles down. It pays to compare!

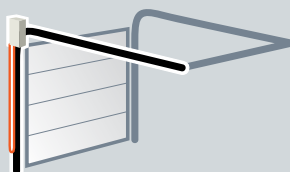

Hörmann's optimal arrangement

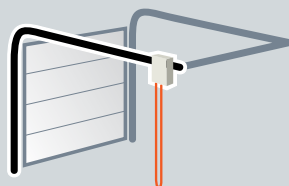

Competitors' disruptive arrangement

Full passage height

Under certain circumstances, the low headroom track application enables the full passage height with only 200 mm required headroom.

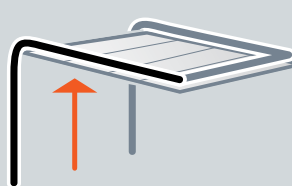

Movable centre support

For large openings of up to 30 m width

Economical combination

This door combination allows for particularly large openings to be closed conveniently and economically by coupling two or three industrial sectional doors. This door combination is especially economical during transport, fitting and service.

Variable door openings

For complete opening, the doors are opened and the centre support is then unlocked and pushed to the side. The individual doors can also be opened independently of each other so that the opening can also be done in segments.



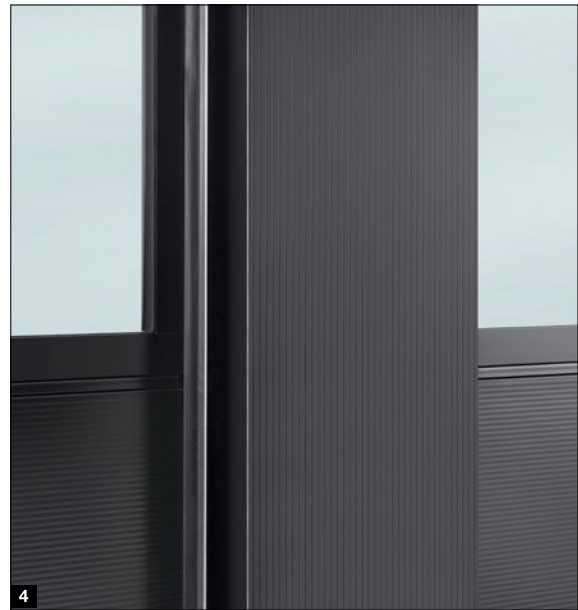
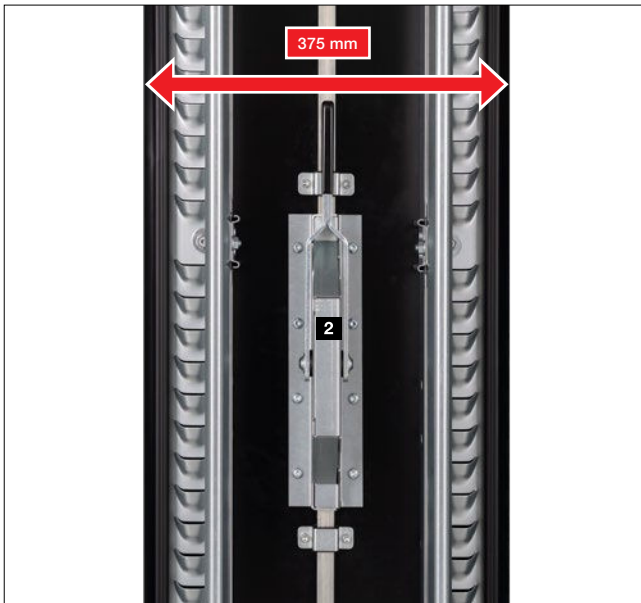
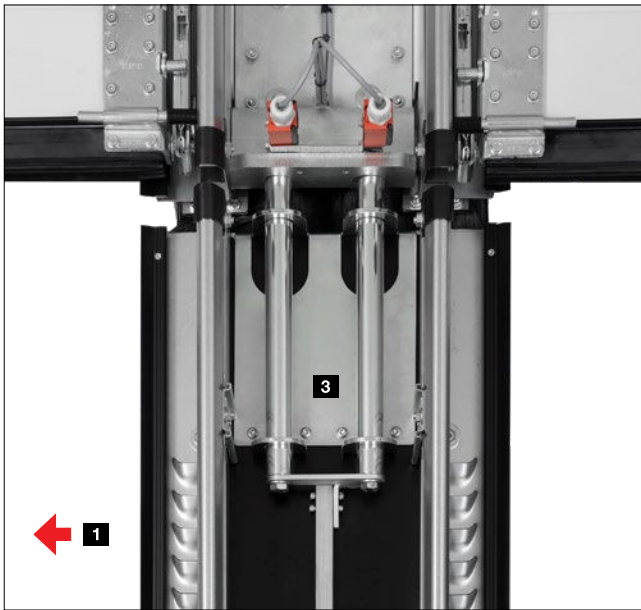

Details

- Can be quickly and easily moved sideways thanks to a low-friction track behind the lintel **1**
- No components swivelling inwards or outwards
- Narrow centre support made of aluminium with a width of only 375 mm
- Espagnolette lock **2** with function monitoring prevents door travel when the centre support is unlocked
- Robust bolts at the lintel and floor for secure closing and reliable transmission of wind loads **3**

Exterior view

- Aluminium as standard with line design **4** in Grey white RAL 9002
- Optionally in preferred colours, in RAL to choose or in special colours (shown in preferred colour Anthracite grey RAL°7016)

Wicket doors with trip-free threshold

with high-quality equipment





Overhead door closer

As standard, wicket doors are supplied with slide rail door closer including hold-open device **1**.

An integrated door closer with hold-open device **2** is optionally available for doors with 42 mm depth for optimum protection and the best appearance.

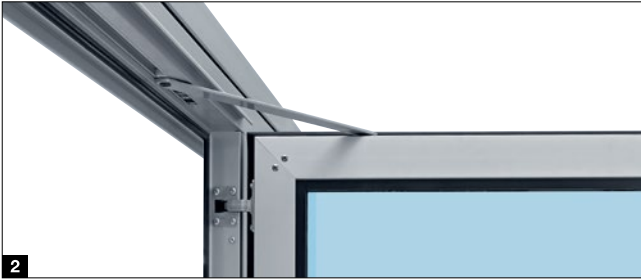

Optional multiple-point locking **3**

The wicket door is locked over the entire door height with one bolt and hook bolt per door section. The advantage: better stability and improved break-in resistance equipment.

Sturdy mechanical hold-open device **4**

The hold-open device prevents door leaf dropping and warping.



Flat wicket door frame **5**

The all-round frame consists of a flat aluminium profile. This way, the wicket door is harmoniously integrated into the door.



Concealed hinges **6**

For a uniform door view, the wicket doors are equipped with concealed hinges as standard.



Finger trap protection (outside and inside)* **7**

The unique shape of the door sections and the wicket door frame eliminate trap points when the door opens and closes.



Optimally sealed **8**

The adjustable threshold profile with flexible seal compensates for unevenness in the floor. Adjustable double seals located in the transitions from the bottom edge of the door to the floor and from the door leaf to the threshold rail optimally seal the bottom edge of the door and the wicket door opening.



* Not for wicket door with 67 mm depth

Wicket doors with trip-free threshold

Fully-fledged passage doors

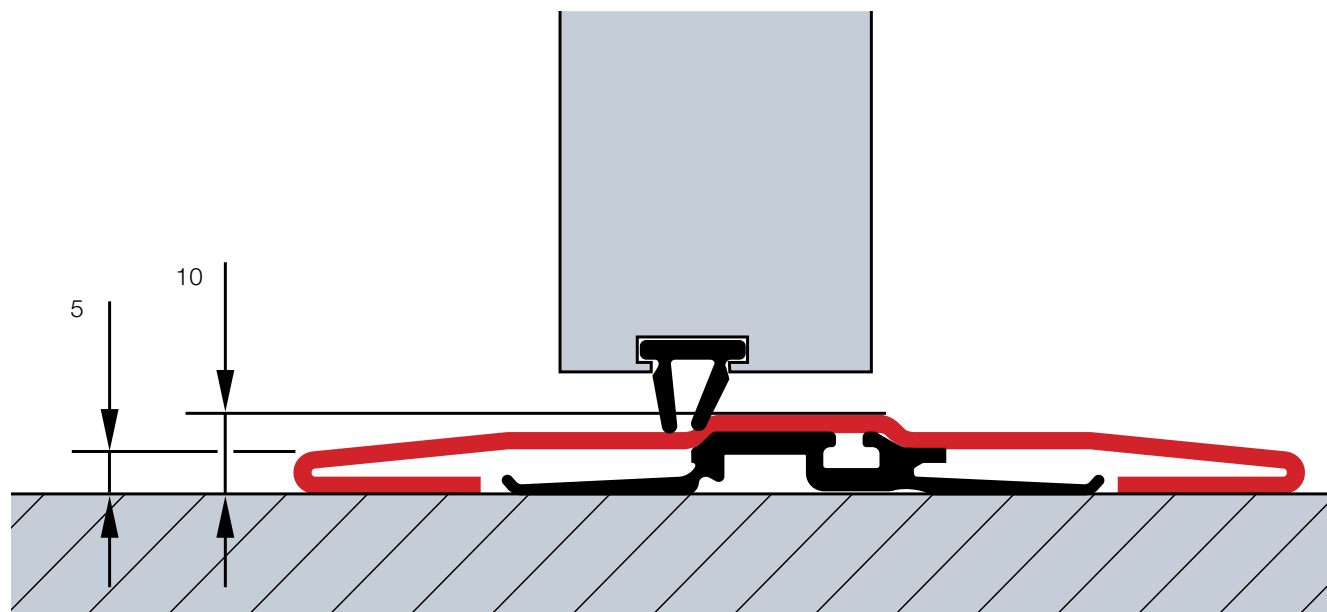

Wicket door construction for sectional doors with 42 mm depth

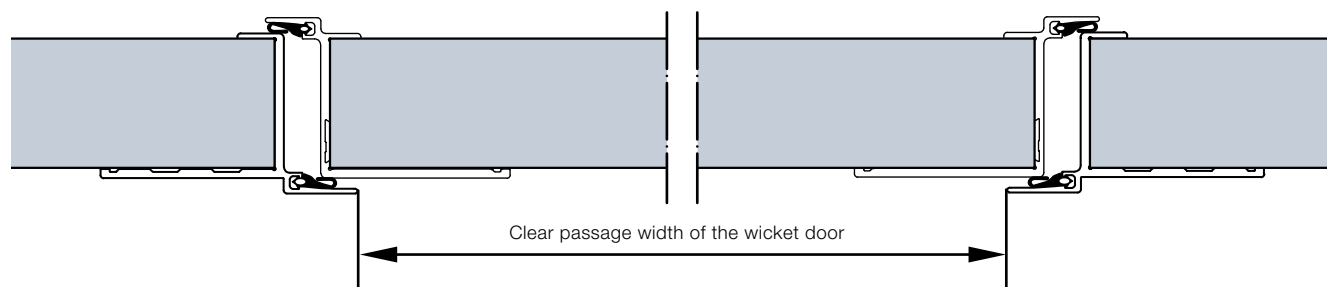

Wicket door construction with thermal break for sectional doors with 67 mm depth

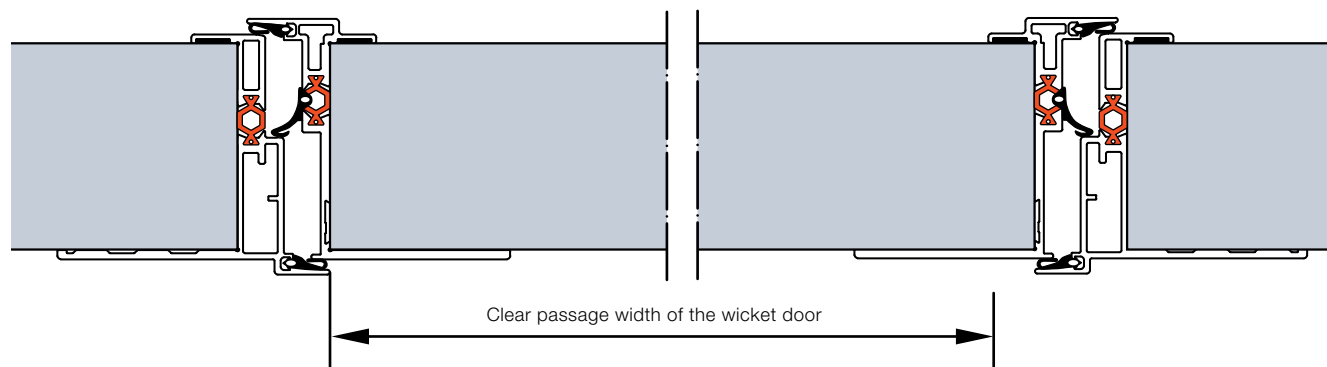

Trip-free passage

The stainless steel threshold rail is 10 mm high at the centre and 5 mm at the edges. We provide a reinforced threshold rail of approx. 13 mm for doors from 5510 mm width or for doors with wicket door and real glass from 4510 mm width.

940 / 905 mm clear passage width as standard

Under certain circumstances, the wicket door with trip-free threshold, with its clear passage width of 940 mm (depth 42 mm) or 905 mm (depth 67 mm), fulfils the requirements for an escape door and for barrier-free construction.

Freely selectable position

The wicket door can be positioned to the left, right or at the centre (except for the two outermost fields). The window sections above the wicket door have a clear view of 1025 mm as standard. All other sections of the door have identical widths.

Example door versions

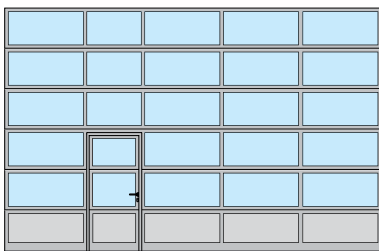

Wicket door arrangement on the left

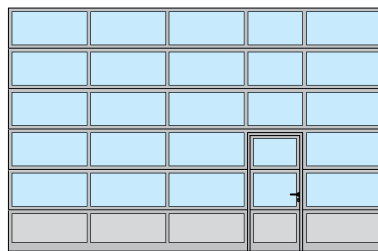

Wicket door arrangement on the right

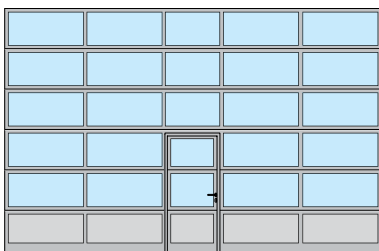

Wicket door arrangement in the centre

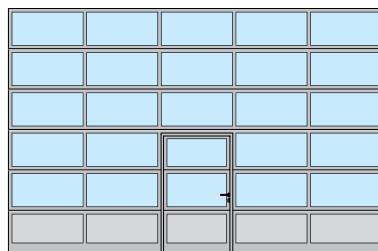

Wicket door arrangement in the centre with uniform field division



Escape door

Under certain circumstances, Hörmann doors with wicket door and trip-free threshold fulfil the requirements of an escape door (for doors up to 5500 mm width or for doors with real glass up to 4510 mm width).



Unobstructed entrance

Under certain conditions, Hörmann sectional doors with wicket door and trip-free threshold fulfil the requirements for accessibility in accordance with DIN EN 18040-1 and are certified by the ift Rosenheim.

Note

On request, doors with wicket door are also available with uniform field division and the wicket doors can be supplied in individual sizes or, to match existing doors, even with threshold rail. We recommend the wicket door with threshold rail for inclining surfaces in the opening area.

Side doors

Matching the door

Side door NT 60 **1**

- 60 mm aluminium frame construction
- As standard with all-round seals made of long-lasting, weather-resistant EPDM
- Infill variants same as for sectional doors with 42 mm depth
- Infill fixed by glazing beads

- 1** Exterior view
- 2** Interior view with synthetic glazing
- 3** Viewed from inside with sections
- 4** Lever handle set as standard



Side door with thermal break NT 80 Thermo **5**

- 80 mm aluminium frame construction with thermal break
- As standard with all-round seals made of long-lasting, weather-resistant EPDM
- Infill variants with thermal break same as for doors with 42 mm and 67 mm depth
- Infill fixed by glazing beads

- 5** Exterior view
- 6** Interior view with triple synthetic glazing
- 7** Lever handle set as standard
- 8** Thermal break between door leaf, frame and threshold rail



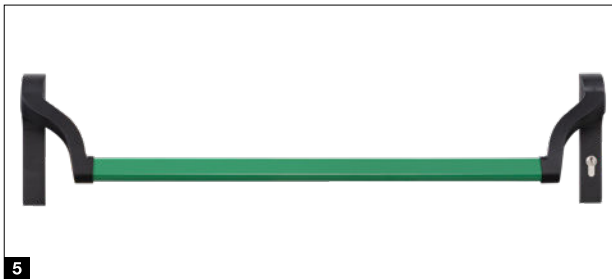
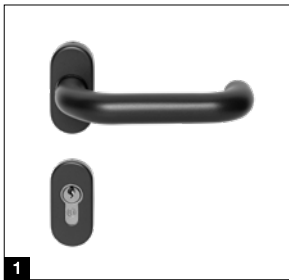

Door hardware

- Mortice lock with profile cylinder
- Offset lever handle set, with oval rose escutcheons made of black plastic **1**
- On request also available as lever / knob handle sets
- Optionally available in natural finish cast aluminium **2**, polished stainless steel **3** or brushed stainless steel **4**

Optional equipment

- Tested break-in-resistant RC2 security features according to DIN EN 1627
- Stainless steel push bar 38-2, brushed, 1000 mm high, exterior, additionally with stainless steel lever handle set, interior
- Overhead door closer with hold-open device
- Push bar **5** in black / green or stainless steel, for escape door, inside (anti-panic lock required)
- Multiple-point locking also with anti-panic functions B, D, E



Multi-purpose door MZ Thermo65

Steel side doors with thermal break

- 65 mm thick door leaf with thermal break and PU rigid foam infill
- Aluminium block frame with thermal break and threshold with thermal break
- High thermal insulation with a U-value = 0.82 W/(m²·K)
- Optionally available with RC2 security features as KSI Thermo46 with 46 mm thick door leaf



For further information, see the "Steel doors" brochure.

Individual colour schemes

For greater design freedom

High-quality coating

- 11 preferred colours as well as RAL and NCS, in many metallic colours as well as acc. to British Standard¹⁾
- High-quality coil coating for double-skinned sections in preferred colours, Grey white RAL 9002 on the inside
- High-quality wet coating (2C PUR) on the outside or outside and inside for all other colours
- Door leaf reinforcements and end caps in Grey white, RAL 9002, as standard²⁾

Optional colour coatings

- Wicket door frame profiles in anodised aluminium E6 / C0 on the outside, inside
- Leaf frame and door frame of side doors
- Aluminium glazing frame and glazing beads
- External frame of compound windows type A (die-cast frame) and type D (plastic frame), internal frame black as standard

Preferred colours

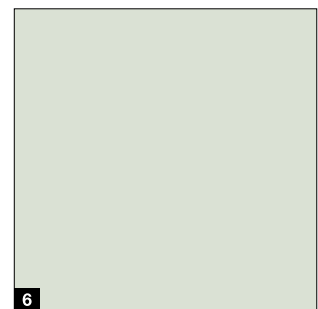
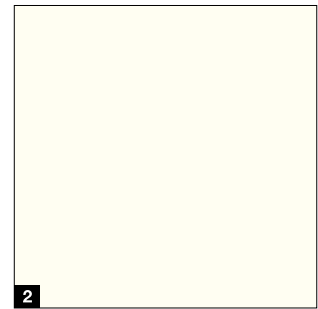
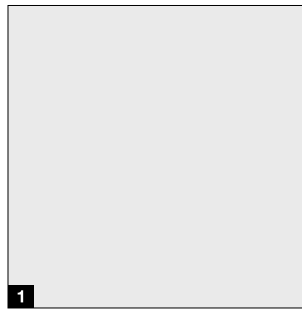

Note

Dark colours should not be used for double-skinned steel doors and for doors with thermal break that are exposed to the sun, as possible section deflection may restrict the door's function (bi-metal effect). The colours shown are subject to the limitations of the printing process and cannot be regarded as binding. Contact your Hörmann specialist dealer for advice regarding coloured doors. All colours based on RAL.

¹⁾ With the exception of pearl-effect and fluorescent colours, slight colour variations are permissible

²⁾ Excluding ALR F42 Vitraplan and Vitraplan AT

Doors with double-skinned steel sections in preferred colours are supplied in Grey white, RAL 9002, on the inside **1**. The frames for compound windows are black as standard on the interior of the door.

Door leaf reinforcements and the end caps of the door sections on the inside of coloured doors are supplied in Grey white, RAL 9002, as standard²⁾. For doors with wicket door, the frame of the wicket door on the inside consists of aluminium profiles in E6 / C0 **2**.

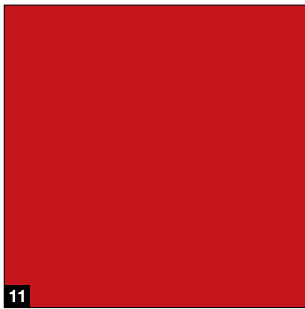
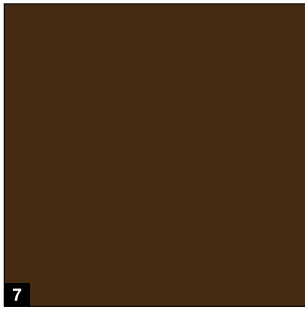
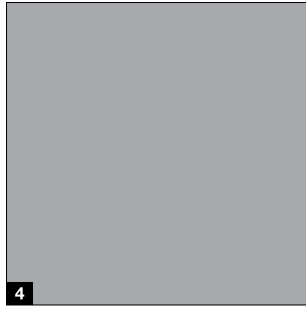
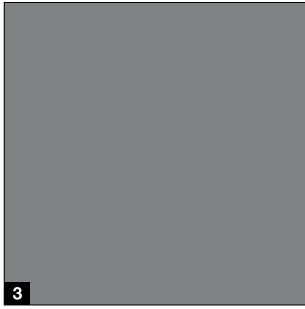

At no surcharge

Preferred colours for double-skinned steel sections in all depths

- 1 RAL 9016 Traffic white
- 2 RAL 9010 Pure white
- 3 RAL 9007 Grey aluminium
- 4 RAL 9006 White aluminium
- 5 RAL 9005 Jet black
- 6 RAL 9002 Grey white
- 7 RAL 8028 Terra brown
- 8 RAL 7016 Anthracite grey
- 9 RAL 6005 Moss green
- 10 RAL 5010 Gentian blue
- 11 RAL 3000 Flame red



Glazings and infills

For more light and better ventilation

	Duratec glazing	SPU F42	SPU 67 Thermo	APU F42	APU F42 Thermo	APU 67 Thermo	ALR F42	ALR F42 Thermo	ALR 67 Thermo	ALR F42 Glazing	ALR F67 Thermo Glazing	ALR F42 Vitraplan	ALR F42 Vitraplan AT
<p>● = Possible * Only in white (opal)</p>													
Aluminium glazing frame													
Synthetic panes													
Clear single pane	●	●		●			●						
Single pane, crystal structure		●		●			●						
Clear double pane	●	●		●	●		●	●				●	
Double pane, crystal structure		●		●	●		●	●				●	
Double pane, tinted in grey or white (opal)	●	●		●	●		●	●				●*	
Clear triple pane	●		●			●			●				
Triple pane, crystal structure		●	●	●	●	●	●	●	●			●	
Triple pane, tinted in grey or white (opal)	●	●	●	●	●	●	●	●	●			●*	
Clear quadruple pane	●		●			●			●				
Quadruple pane, crystal structure			●			●			●				
Quadruple pane, tinted in grey or white (opal)	●		●			●			●				
Polycarbonate panes													
Clear single pane	●	●		●			●						
Clear double pane	●	●		●	●		●	●				●	
Clear triple pane	●		●			●			●				
Clear quadruple pane	●		●			●			●				
Real glass panes													
Clear single pane, laminated safety glass		●		●			●			●			
Clear double pane, single-pane safety glass		●	●	●	●	●	●	●	●	●	●		
Clear double climatic pane, single-pane safety glass		●	●	●	●	●	●	●	●	●	●		
Infills													
Multiple-moulded pane		●		●	●		●	●					
Stainless steel expanded mesh Ventilation cross-section: 54% of the infill surface		●		●			●						
Perforated stainless steel sheet Ventilation cross-section: 40% of the infill surface		●		●			●						
PU infill, aluminium sheet cladding, anodised on both sides, smooth				●	●	●	●	●	●				●
PU infill, aluminium sheet cladding, Stucco-textured on both sides				●	●	●	●	●	●				●

A permanently clear view

The Duratec glazing is available as standard for all sectional doors with clear synthetic glazing, at no surcharge.

With Duratec synthetic glazing, Hörmann sectional doors retain their clear view permanently, even after multiple cleans and heavy use, unlike with standard synthetic glazings.

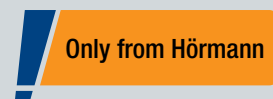

Duratec
Synthetic glazing
with maximum
scratch resistance

Aluminium glazing frame

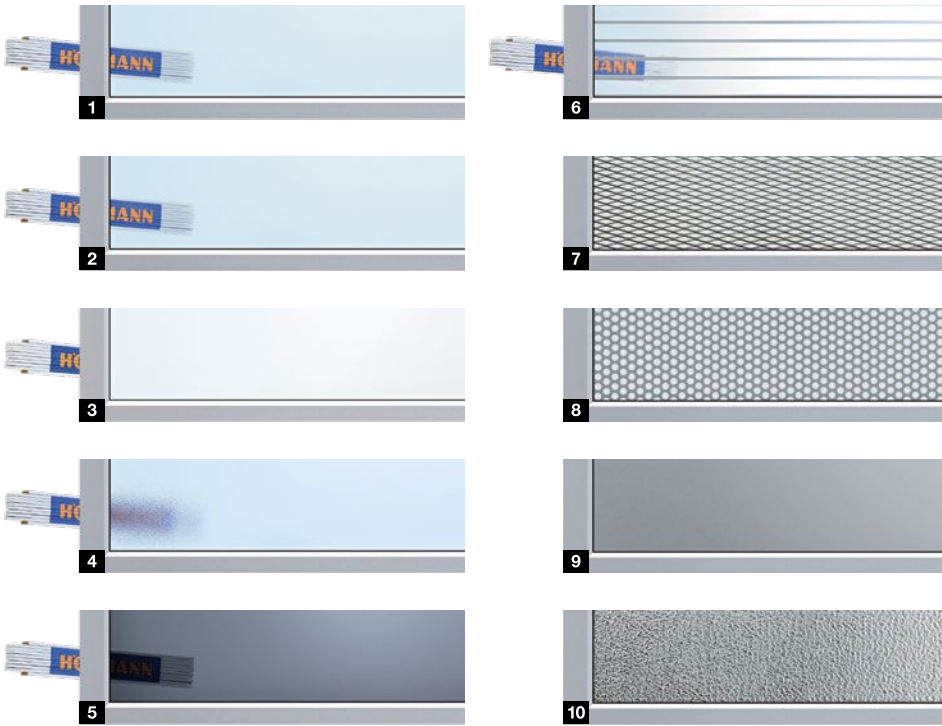
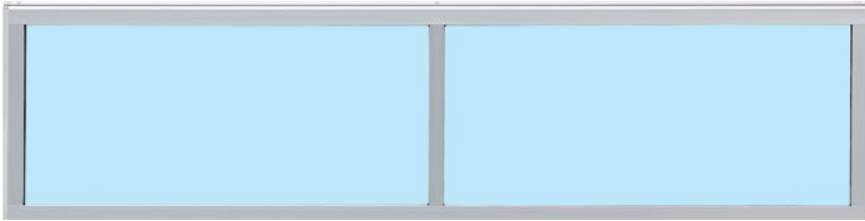

- 1 Polycarbonate double pane, clear
- 2 Synthetic double pane, clear
- 3 Synthetic double pane, white tinted (opal / clear)
- 4 Synthetic double pane, crystal structure
- 5 Synthetic double pane, grey tinted

- 6 Multiple-moulded pane
- 7 Stainless steel expanded mesh
- 8 Perforated stainless steel sheet
- 9 PU sandwich infill, smooth
- 10 PU sandwich infill, Stucco

Aluminium glazing frame

Thermal break	Without	With
Standard	Anodised in natural finish E6 / C0	Anodised in natural finish E6 / C0
Optional	Colour coating on the interior and exterior	Colour coating on the interior and exterior
Clear view	Depending on version	Depending on version
Rail extrusion	52 mm, optionally 91 mm*	52 mm, optionally 91 mm*

* Only 42 mm depth

Excellent thermal insulation as standard

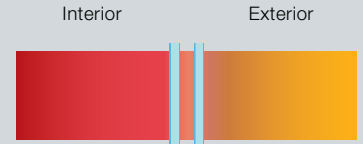

Conventional double pane, 16 mm from other manufacturers



Up to 20% improved thermal insulation*
Duratec double pane, 26 mm (as standard)

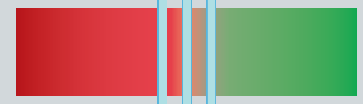

Up to 35% improved thermal insulation*
Duratec triple pane, 26 mm (optional)



Up to 40% improved thermal insulation*
Duratec triple pane, 51 mm (optional),

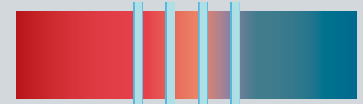

Up to 55% improved thermal insulation*
Duratec quadruple pane, 51 mm (optional),



Up to 65% improved thermal insulation*
Double climatic pane, 26 mm (optional),

* compared to conventional 16 mm double panes of other manufacturers

Glazing

For more light

	● = Possible	Duratec glazing	SPU F42	SPU 67 Thermo
--	--------------	-----------------	---------	---------------

Compound windows

Synthetic panes

Synthetic double pane, clear, plastic frame	●	A, D, E, F	
Clear double pane, die-cast frame	●	A	
Clear triple pane, synthetic frame	●		D, F
Clear triple pane, die-cast frame	●		A
Clear quadruple pane, die-cast frame	●		A

Polycarbonate panes

Clear double pane, die-cast frame	●	A	
-----------------------------------	---	---	--

Real glass panes

Clear double pane, single-pane safety glass		A	
Clear triple pane, single-pane safety glass			A

Compound windows

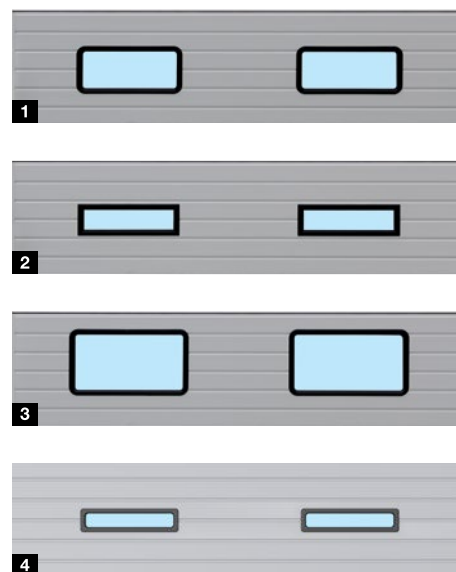

- 1 Compound windows type A
- 2 Compound windows type D
- 3 Compound windows type E
- 4 **NEW.** Compound windows type D

Compound windows

	Type A	Type D	Type E	NEW. Type F
Standard	Plastic or die-cast frame in black	Plastic frame in black	Plastic frame in black	Plastic frame in black
Optional	Die-cast frame with colour coating on the exterior	Colour coating on the exterior		
Clear view (width x height)	635 x 245 mm	602 x 132 mm	725 x 370 mm	540 x 83 mm
Door section height	500, 625, 750 mm	500, 625, 750 mm	625, 750 mm	375, 500, 625, 750 mm

A permanently clear view

The Duratec glazing is available as standard for all sectional doors with clear synthetic glazing, at no surcharge.

With Duratec synthetic glazing, Hörmann sectional doors retain their clear view permanently, even after multiple cleans and heavy use, unlike with standard synthetic glazings.

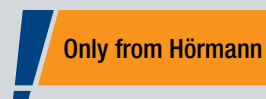

Duratec

Synthetic glazing with maximum scratch resistance

Reliable security features

For protecting goods and machines

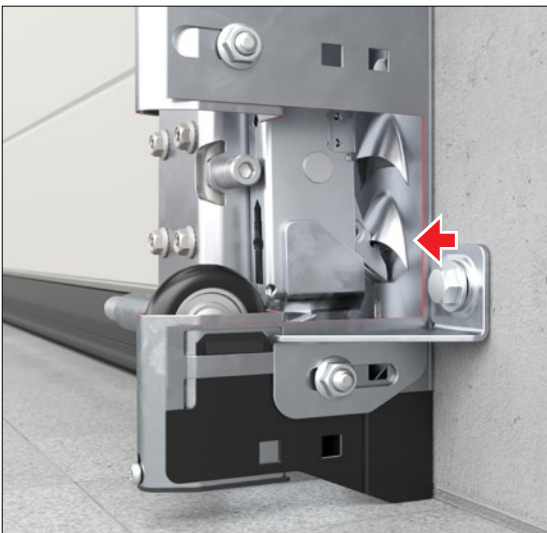

The locking hook of the anti-lift kit automatically latches if the door is forced upwards.

Only from Hörmann

Anti-lift kit on both sides



Anti-lift kit as standard



Optional RC2 security features

Tested and certified

Anti-lift kit as standard

It is also important for industrial doors to be reliably break-in-resistant to protect your goods and machines. Hörmann supplies all industrial sectional doors with a break-in-resistant anti-lift kit on both sides as standard. This mechanical protection reduces the risk of the door being pushed open by force, even in the event of a power failure. In sectional doors with rail-guided operators ITO 500 FU, self-locking gearbox or patented door locking in the operator boom (SupraMatic HT) makes forced opening even more difficult.

Optional RC2 security features

For especially high break-in resistance equipment, industrial sectional doors SPU F42 and SPU 67 Thermo are optionally available in resistance class RC 2 – tested and certified in accordance with the new standard DIN/TS 18194. This certified security is also recommended by police information centres. Further information can be found at www.k-einbruch.de

Locking

For manual or power-driven doors

Securely locked as standard

Shootbolt with adjustable lock plate

This can be secured with an on-site padlock as a secure night lock.



Rotary latch with locking bolts that can be adjusted horizontally and vertically

This door lock automatically locks itself through the latching disc.



Only from Hörmann

Floor locking

This enables frequently used doors to be released by foot. The automatic locking audibly engages when the door is closed.



Only from Hörmann

Automatic locking

A bolt automatically locks the door when the "CLOSE" end-of-travel position is reached. When locked, the bolt is mechanically blocked and thus protected against possible manipulation by simply pushing the bolt in by hand. Manual emergency release is still possible at any time, either as a quick release or as a secured release. The locking is available in two variants: ETV1-HCP¹⁾ for controls 545 and 560 and ETV1²⁾ for controls 360, 445 R and 460 R and for third-party controls.

¹⁾ "Locked" message possible via the control (required for the control 545 multi-function circuit board)

²⁾ With ETV1, additional limit switch reporting is required



Operation options

For manually operated doors

Locking operation from outside

Handle set

With the handle set, the door lock can be ergonomically operated from outside. From inside, the lock is operated via T-handle and securing split pin.

The profile cylinder can also be integrated into central locking systems.

Recessed handle set

Thanks to a flat design and flexible installation height, the handle set is ideal for loading ramp doors in logistics applications. You can operate two functions with the locking cylinder: permanently unlocked door and automatic re-locking.

All parts on the inside are protected by cladding.



Shootbolt



Rotary latch



Shootbolt



Rotary latch

Manual operation from inside

Manual

with rope or link steel chain

Chain hoist

Chain tensioner

for easier operation





WA 300 S4

230 V 1-phase current

- Soft start and soft stop for gentle door travel
- Power limit in OPEN / CLOSE directions
- Max. opening speed 19 cm/s
- Max. 150 door cycles per day
- Max. 10 door cycles per hour
- Integrated control with push button DTH-R
- Optional external control 360 (prepared for traffic control)
- Small side room of only 200 mm
- No installations or wiring required on the door leaf¹⁾
- Standby approx. 1 W²⁾
- Max. door width 6000 mm
- Max. door height 4500 mm

¹⁾ Except for doors with wicket door

²⁾ If no other electrical accessories are connected

Fitting versions

Diagonal **1**

Vertical **2**

Safe “CLOSE” door travel at reduced speed

All OPEN door travel as well as CLOSE door travel above a 2500 mm opening height takes place at a speed of up to approx. 19 cm/s. With an opening height below 2500 mm, CLOSE door travel must be set to approx. 10 cm/s for safety reasons. This restriction does not apply to optional leading photocells or safety edges, meaning the door opens and closes at approx. 19 cm/s.

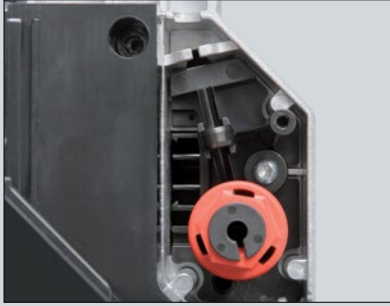

Maintenance release directly on the operator

During the statutory annual inspection work, the operator does not have to be laboriously removed from the barrel. This saves you time and money. The maintenance release can be converted to a secured release at any time.



Combination control 420 Si / 420 Ti for operator and dock leveller

This easy-to-fit solution combines door operation with a standard dock leveller control in one housing. The control housing is prepared for retrofitting, e.g. with option relay HOR1-300 for OPEN limit switch reporting for dock leveller release. Optionally available for operator WA 300 S4 with integrated control.



Battery HNA-300

With this emergency power supply in an external housing, you can bypass network power failures for up to 18 hours and max. 5 door cycles (dependent on the temperature and charge level). The emergency battery recharges itself during normal operation. Optionally available for operator WA 300 S4 with integrated control.



**Soft start
Soft stop**

Quiet, gentle door travel sustainably increases the service life of the door system.



**Easy to fit
and service**

Due to the standard power limit, doors without wicket door do not require any installations such as safety edges or rope failure devices on the door leaf. This reduces costs and the risk of repairs and other services.



**Lower investments,
lower consumption**

The price of the WA 300 S4 is approx. 30% lower than with a 3-phase current operator. At the same time, daily power consumption is reduced by up to 50%.

Shaft operators

WA 500 / WA 500 FU



WA 500

230 V 1-phase current

- Max. opening speed 0.3 m/s
- Max. 12 door cycles (Open / Close) per hour¹⁾
- Max. door leaf weight 350 kg
- Max. door width 4500 mm
- Max. door height 4500 mm
- Can be combined with controls 545, 560
- Standby under 2 W²⁾

400 V 3-phase current

- Max. opening speed 0.3 m/s
- Max. 15 door cycles (Open / Close) per hour¹⁾
- Optionally with increased on-time of max. 20 door cycles (Open / Close) per hour¹⁾
- Exceptionally smooth running
- Long on-time
- No door size restriction
- Can be combined with controls 545, 560
- Standby under 2 W²⁾

WA 500 FU

230 V 1-phase current

- Soft start and soft stop for gentle door travel
- Max. opening speed 1.0 m/s³⁾
- Max. 25 door cycles (Open / Close) per hour¹⁾
- Optionally with increased on-time of max. 30 door cycles (Open / Close) per hour¹⁾
- Constant door travel speed also with track applications H and V **.EUROPEAN PATENT**
- Can be combined with controls 545, 560
- Standby under 2 W²⁾

Only from Hörmann

Constant door travel speed also with track applications H and V



Electricity cost saving of approx. 80%²⁾

¹⁾ Based on max. ambient temperature of +40°C, 5 door cycles (Open / Close) per hour are possible

²⁾ Power consumption in energy-saving mode without any connected accessories

³⁾ With chain box and control 560



Standard maintenance release

During the statutory annual inspection and maintenance work, the operator does not have to be laboriously removed from the spring shaft. This saves you time and money. The maintenance release is pre-equipped for the secured release and can be retrofitted at any time without converting the release.



Optional emergency operation for maintenance release:

Emergency crank handle

The low-cost option is available in two versions, as a fixed crank handle or jointed emergency crank handle. Retrofitting with an emergency hand chain is possible.



Emergency hand chain

Through a combination of the emergency hand chain and the optional secured release, the door can be released or operated from the floor.



Soft start Soft stop

Operator WA 500 FU

The frequency converter control takes stress off all the mechanical door elements, guaranteeing almost wear-free, quiet door travel.



Opening speed up to 1.0 m/s

Operator WA 500 FU with chain box and control 560

Shaft operator WA 500 FU impresses with an opening speed of up to 1 m/s, streamlining workflows, speeding up logistics processes and reducing thermal losses.



Adaptive door action check

Operator WA 500 FU

The frequency converter operators WA 500 FU / ITO 500 FU with intelligent speed control feature a compact design with high torques over a large speed range. The adaptive door action check recognises uneven door travel going beyond typical fluctuations, for example caused by reduced spring tension. In this case, the operators automatically switch to a temporary protection mode, signalling to the operator that the door system requires maintenance.

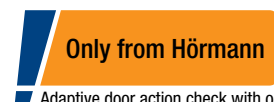

Shaft operators, direct drive operators

Fitting versions

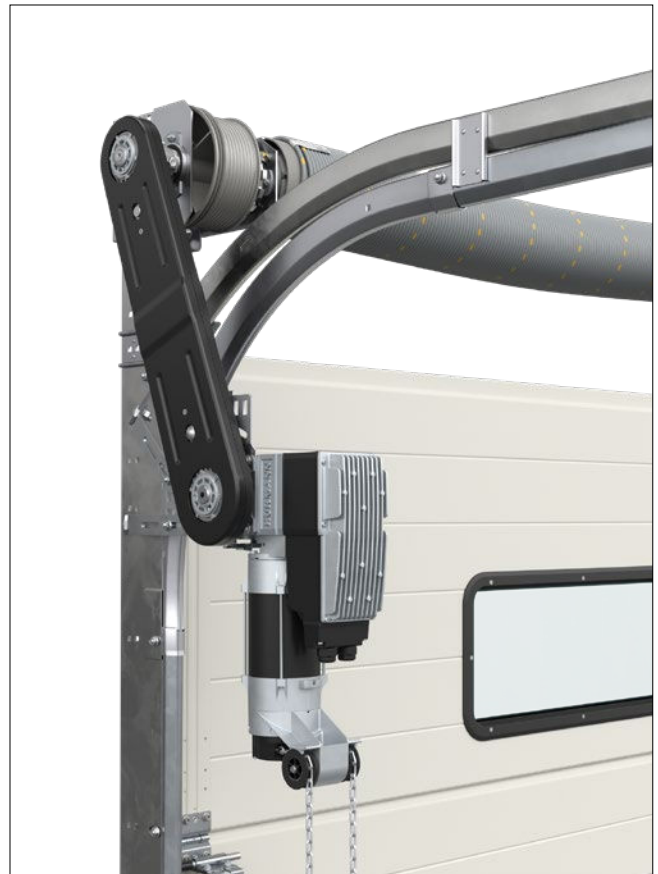

Operator to flange

WA 500, WA 500 FU (Fig. above)

The flange version is quick and easy to fit to the spring shaft and requires considerably less sideroom than the direct drive solutions from other manufacturers.

Operator with chain box

WA 500, WA 500 FU (Fig. above)

We recommend operators with chain box for all door types up to a height of 7500 mm if there is only sideroom of up to 200 mm. For track applications L and LD, an operator with chain box is required. Due to the indirect transmission of forces, the door is subjected to minimum wear and friction.



1.0 m/s opening speed

Operator WA 500 FU with chain box and control 560

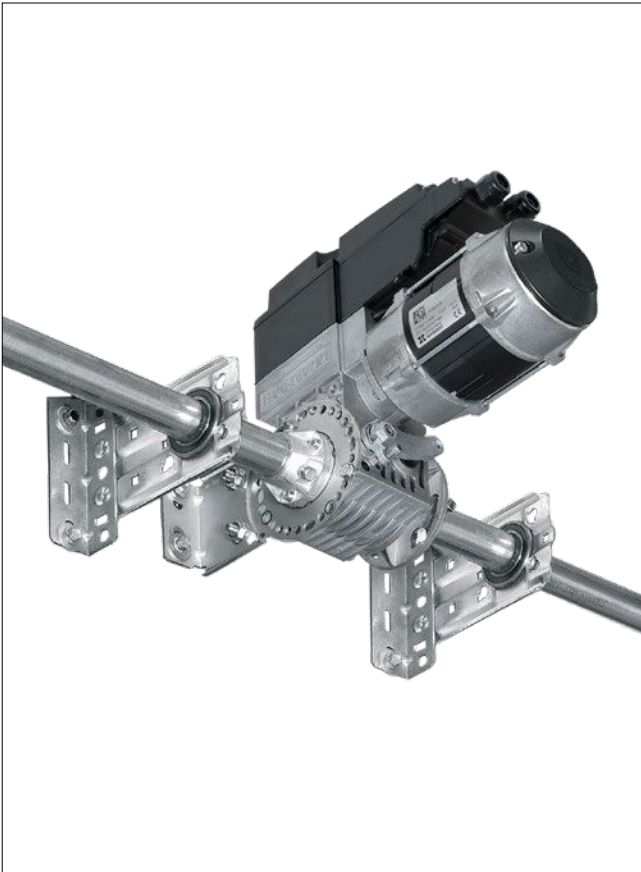

Operator for central fitting

WA 500 M, WA 500 M FU

This version is mounted centrally on the spring shaft; as a result, no additional sideroom is necessary. Please observe the minimum headroom. The operator includes a secured release as a standard feature and is suitable for virtually any track application.

Direct drive operator S140

(not shown)

- Ready-to-fit direct drive operator with rope failure device and integral catch safety device
- Power input: 3-phase current: 1.1 kW
- Protection category IP 65 (jet-water protected)
- Electronic absolute encoder (AWG) for determining the door position
- Microprocessor control in separate housing, with Open-Stop-Close membrane push button integrated in housing, miniature lock
- Self-monitoring safety edge via leading photocell VL1-LE including protective covers
- Connection cable with CEE plug in protection category IP 44 (splash-water protected)
- Fitting of the control immediately next to the sectional door, plug-in door leaf sensors
- Including intel trap guard EZS 1
- Including radio transmission (omission of the coiled cable)
- Opening with impulse
- Closing with impulse
- Max. door leaf weight 1080 kg
- Max. door width 10000 mm
- Max. door height 7500 mm
- Can be combined with controls 445 R, 460 R

Chain drive operators with rail

ITO 500 FU, SupraMatic HT



ITO 500 FU

- Soft start and soft stop for gentle, quiet door travel
- Max. opening speed 0.5 m/s
- Max. 25 door cycles (Open / Close) per hour*
- Adaptive door action check (for further information, see page 81)
- No additional sideroom required
- Emergency release via Bowden cable on the slide carriage
- Maintenance release as standard
- Emergency release from the outside possible
- Optionally secured release on the inside / outside (ideal for use on facade doors)
- For standard track application (N, ND) and low headroom track application (L, LD)
- Max. door height 4500 mm
- For doors with wicket door on request

* Based on max. ambient temperature of +40°C, 5 door cycles are possible

Operator SupraMatic HT

- Soft start and soft stop for gentle, quiet door travel
- Max. opening speed approx. 0.22 m/s
- Max. 20 door cycles (Open / Close) per hour
- Pull and push force 1000 N (brief peak force 1200 N)
- Integrated control electronics including double 7-segment display for simple adjustment of operator functions directly on the operator
- Optional external control 360 (for connecting traffic control, warning lights or additional prints)
- Patented door locking in the operator boom with emergency release from inside
- Connecting lead with CEE plug, second suspension
- For doors with a spring safety device
- Up to 6750 mm width (7000 mm on request), or 3000 mm height
- For standard track application (N) and low headroom track application (L)
- For doors with wicket door, ALR F42 Glazing and real glass on request
- Not for sectional doors with 67 mm depth



0.5 m/s opening speed

For operator ITO 500 FU with control 560

Releases and emergency operation

For convenient operation

Secured release on the inside (optional) **1**

- For the convenient release of the operator from the floor

Secured release from outside ASE (optional) **2**

- For release from the outside (required for buildings without a second entrance)
- Lockable die-cast housing with profile half cylinder
- Dimensions: 83 × 133 × 50 mm (W × H × D)

Emergency operation / emergency actuation

- Recommended for doors over 3000 mm and fire station doors
- Secured release is required
- Meets the requirements of fire brigade standard DIN 14092 (depth of 42 up to 5000 mm or depth of 67 up to a door width of 5500 mm)

Push rod (optional) **3**

- Not available for doors with wicket door

Manual for emergency actuation of doors with operator (optional) **4**

- Compactly fitted to the door frame



Controls

Compatible system solutions



Internal control WA 300 S4 External control 360 Impulse sequence control 445 R Comfort control 460 R Control 545 Control 560

Operators	WA 300 S4	S75, S140	WA 500, WA 500 FU, ITO 500 FU
Functions / features			
Control and operator can be fitted separately	●	●	●
Illuminated keypad			●
Smart installation with BlueControl app via Bluetooth as standard			●
Adjustment work can be conveniently done directly on the control	●	●	●
Soft start and soft stop	●	●	● ¹⁰⁾
Adjustable high-speed opening and closing (depending on track application)	● ¹⁾	● ¹⁾	●
Power limit in OPEN / CLOSE directions	● ²⁾	● ²⁾	● ¹⁰⁾
Integrated Open / Stop / Close operation	●	●	●
Second opening height with additional button in the control cover	○ ³⁾	●	●
7-segment display with menu reading from outside (maintenance, cycle and operating hours counter as well as fault analysis)		Double	Quadruple
Extension possible with external radio receiver	●	●	●
Query of the door position	○ ⁴⁾	○ ⁵⁾	○ ⁶⁾
2 timers for programming scenarios in 2 different periods of time			●
Option relay as standard		●	●
HCP bus interface for intelligent accessories			●
Automatic timer	● ⁷⁾	● ⁷⁾	●
Traffic control ⁷⁾		○	○
Connecting terminals for additional command units	●	●	●
Power supply	230 V	230 V	400 / 230 V
Connection cable with CEE plug ⁸⁾ (IP 44)	●	●	●
Main switch integrated into control housing	○ ⁹⁾	○	○
Energy-saving function			●
Protection class IP 65 (jet-water protected) for control and door leaf components	●	●	●

● = As standard

○ = With corresponding equipment with additional control, if applicable

¹⁾ In the CLOSE direction during operation without SKS / VL (during operation with SKS / VL, the door generally travels at high speed in the CLOSE direction)

²⁾ In accordance with EN 12453

³⁾ Possible in combination with UAP 1-300 and DTH-I or DTH-IM

⁴⁾ In combination with ESE BS, HS 5 BS

⁵⁾ In combination with HET-E2 24 BS, HS 5 BS and end-of-travel position feedback

⁶⁾ With ESE BS HCP

⁷⁾ Only in combination with an activating kit for warning lights and photocell, light grille or leading photocell VL1-LE / VL2-LE

⁸⁾ For controls with integrated main switch the connection cable is omitted

⁹⁾ External main switch possible or via control panel 300 U with integrated main switch

¹⁰⁾ Only with WA 500 FU and ITO 500 FU



Profile half cylinder
For all external controls



Main switch
For all external controls



Post STI 1
For fitting a maximum of 2 controls
with additional housing,
colour: White aluminium, RAL 9006,
Dimensions: 200 x 1660 x 60 mm (W x H x D)



Radio transmission unit
To transfer the signals from the door leaf to the control via Bluetooth (no coiled cable), power supply via a powerful battery; connectable components: optosensors LE (low energy), leading photocell VL1-LE/VL2-LE, 8k2 strip, rope failure device, wicket door contact, night latch contact

For all controls



UPS system
For bridging power failures of up to 2 hours and up to 4 door cycles; safety devices, warning lights, etc. remain functional, LED status display, automatic battery test, surge filter, protection category: IP 20
Dimensions: 560 x 235 x 260 mm (W x H x D)

For controls: 360, 545, 560



Battery unit
For control 545 / 560 incl. batteries;
to buffer the time and date of the control if the mains voltage supply is interrupted for longer than the standard buffer of 60 hours

BlueControl

Smart set-up and service of operator control via app

The BlueControl app makes initial start-up, service and maintenance of industrial doors with controls 560 and 545 even easier and more convenient. Scan all door data via a QR code on the door and configure all settings in plain text. Existing configurations can be saved and transferred to similar door systems. In case of malfunction, the operator can send the malfunction report directly to the Technical Service for specific assistance via the BlueControl app. This saves you time and money.

Advantages for the service technician

- Clear settings in plain text
- Simple scanning of the door data via QR code
- Convenient saving and transferring of templates for programming identical systems
- Simple reset of maintenance counter

Advantages for the operator

- Clear app for free download and use
- On-site access via Bluetooth without internet connection
- Fast overview of all menu settings
- Practical readout of events and errors with timestamp
- Time-saving forwarding of control data via e-mail



BlueControl

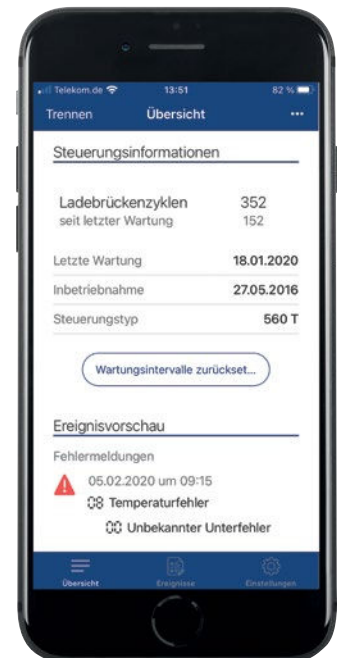



NetControl

The latest generation of industrial sectional doors can also be integrated into digital service and maintenance concepts. With the NetControl gateway, you get robust logistics processes with regard to your door system. This minimises downtimes through the preventive replacement of wear parts.

Advantages at a glance

- Monitoring and controlling industrial door and loading technology systems
- Transparent overview of door and / or dock leveller status on master computers
- Display of all important information, such as status, error messages, cycles, opening duration and maintenance instructions
- View of all connected controls on a dashboard for easy analysis
- Control several doors simultaneously as a central control, e.g. for fire brigades
- Remote access through on-site solutions, such as a VPN connection
- Cost-savings thanks to fewer and shorter service visits
- Fewer and shorter downtimes due to timely replacement of wearing parts
- Optimisation of service and maintenance scheduling through forward planning
- Lorry detection, status queries for side doors, locking activation, etc. with optional I / O card
- Easy connection of the NetControl gateway via the HCP bus of up to 3 controls of the series 500
- Available for all Hörmann industrial doors with the 545 and 560 controls



Controls

Air inlet control AC72

For smoke extraction concepts with industrial doors

Smoke and heat extraction systems are an essential part of preventive fire protection and personal safety. In the event of fire, windows and transom lights in the facade and ceiling area are opened, allowing smoke and fumes to be discharged from the building. At the same time, fresh air is supplied from below via building openings such as inlet flaps in the building facade.

Thanks to the air inlet control AC72, door systems can also be integrated into smoke extraction concepts to securely supply fresh air. When the fire alarm system is triggered, the AC72 automatically transmits the impulse for door opening to the required opening height within 60 seconds. Additionally, the AC72 complies with the general requirements for smoke extraction systems, such as monitored battery operation in case of power failure for 72 hours. By integrating industrial doors into the smoke extraction concept of your building, you can reduce the investment and fitting costs of additional ventilation flaps. And because fewer doors need to be integrated into the facade, this improves the building's thermal insulation as well.

- Fulfills the requirements of FVLR Directive 13 (trade association for daylight and smoke ventilation):
Downstream openings for smoke and heat exhaust ventilation systems
- Conforms to product standard for doors DIN EN 13241

Inlet air control based on

DIN EN 12101-2/3 and DIN 18 232-9 (8)

- Automatic opening within 60 seconds
- Monitored battery operation in case of power failure for 72 hours
- Monitoring of the line from the RWA to the AC72

Protection goals for supporting self-rescue and third-party rescue

- Support of firefighting operations
- Prevention of uncontrolled smoke propagation
- Delay or prevention of a flash-over
- Property protection
- Containment of environmental damage

RWA smoke and heat extraction

- Smoke extraction in the event of fire thanks to a robust, low-smoke layer near the floor (by using targeted air supply)
- To ensure escape and rescue routes



**Operator / control combinations
for individual doors:**

- Operator WA 300 R S4 with control 300 U



**Operator / control combinations
for doors with dock leveller:**

- Operator WA 300 R S4 with control 420 Si / 420 Ti



Equipment

Closing edge safety device

Tip

Leading photocells VL1-LE

At no surcharge with operators
WA 500, WA 500 FU, ITO 500 FU

Safety edge with optosensors or with leading photocell

All power-driven Hörmann industrial sectional doors with operators WA 500, WA 500 FU, ITO 500 FU are equipped with a self-monitoring safety edge with optosensors as standard. You can also select the leading photocell VL1-LE **1** for non-contact door monitoring of the closing edge at no surcharge. This solution offers you increased safety, faster door travel and lower inspection and maintenance costs.

Leading photocell

Using the leading photocells VL1-LE **2** and VL2-LE **3** means increasing the safety of Hörmann industrial sectional doors. The sensors monitor the bottom edge of the sectional door. Obstacles or persons are quickly recognised and the sectional door reverses before contact is made. Another benefit is the faster door travel speed.

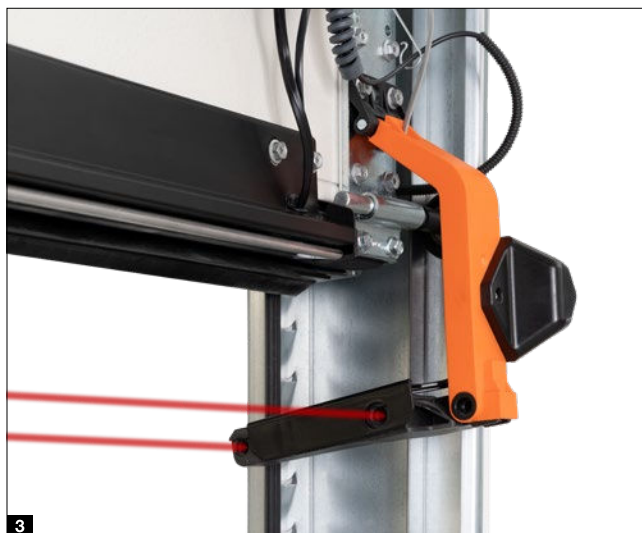
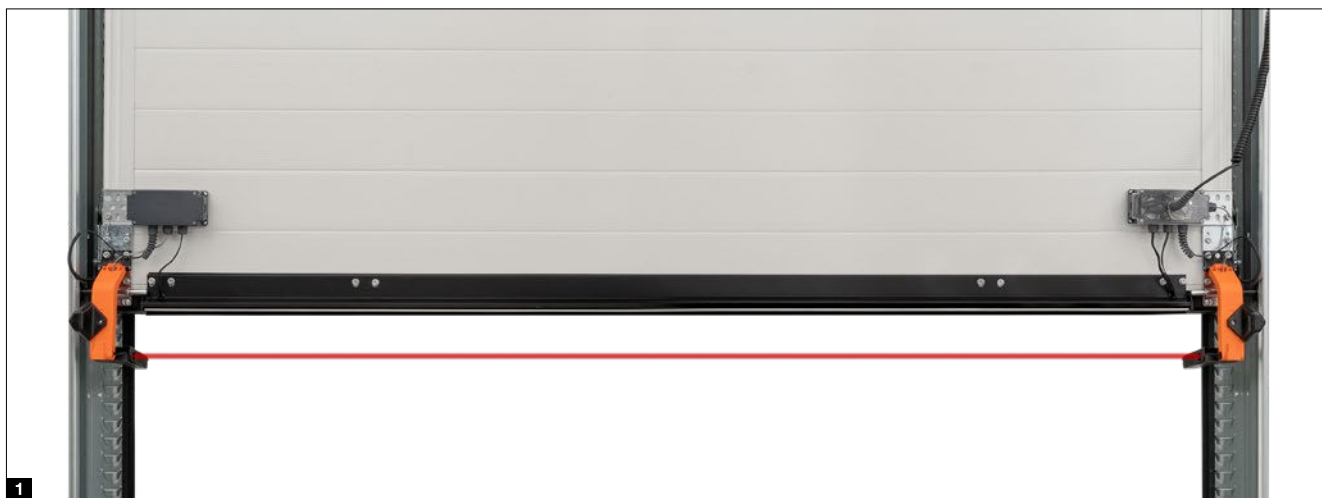

Benefits of leading photocells

Increased safety

Thanks to the non-contact automatic safety cut-out, persons and obstacles are quickly recognised without door contact. The door stops before contact is made and immediately travels upwards. This virtually eliminates the risk of damage or injury.

Faster door travel

The leading photocell can close the door at a speed of up to 30 cm/s. This reduces your energy costs due to shortened door opening times.

Lower inspection and maintenance costs

Industrial doors with non-contact door monitoring approved for personal safety purposes do not need to have their closing force approved. This means you save the extra costs for the additional inspection in accordance with ASR A1.7.

Protection for people and materials

The crash protection at the sides prevents the swivel arm from being damaged when the door is closed (Figures on right).



Equipment

Light grille

Light grille

Light grilles recognise people and obstacles without making contact. This virtually eliminates the risk of damage or injury. A safety edge with optosensors or additional photocells is not required.

Light grille HLG

- Light grille integrated in the frame **1**
- Good protection against damage and accidental readjustments
- Fitting bracket for optimal fixing and alignment in the frame

Light grille HLG-V as advance protection

- Main closing edge safeguard up to a height of 2500 mm
- Fitting outside on the facade, in the reveal **2**
or on the door frame **3**
- Optionally integrated in key switch post set STL **4**
consisting of weather-resistant anodised aluminium

Light grille HLG for doors with wicket door

- Double light grille for doors with wicket door with trip-free threshold
- Main closing edge safeguard up to a height of 2500 mm
- Fitting on the door frame and on the outside in the reveal **5**
- Radio transmission unit required (further information can be found on page 87)

- **Maximum safety**
thanks to especially effective recognition of people and obstacles via angled beams
- **Increased personal safety**
with especially close arrangement of the sensors up to a height of 500 mm (above FFL)
- **Reduced energy losses**
thanks to door closing at speeds of up to 1 m/s*
- **Easy retrofitting**
of existing doors with safety edge with optosensors with the HLG light grille
- **Low inspection and maintenance costs**, inspection of the closing force in accordance with ASR A1.7 not necessary

* WA 500 FU and controls 560 up to a height of 2500 mm, depending on track applications and sizes

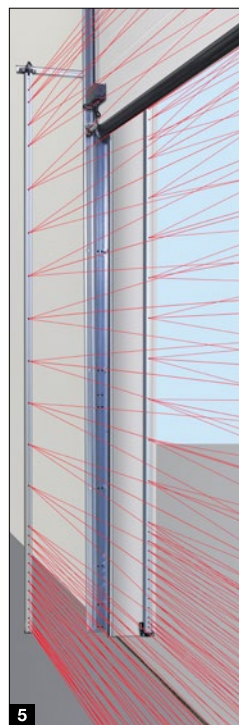
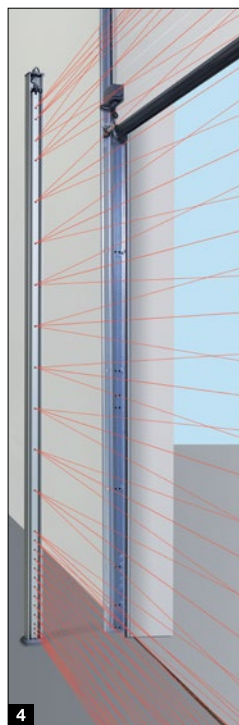
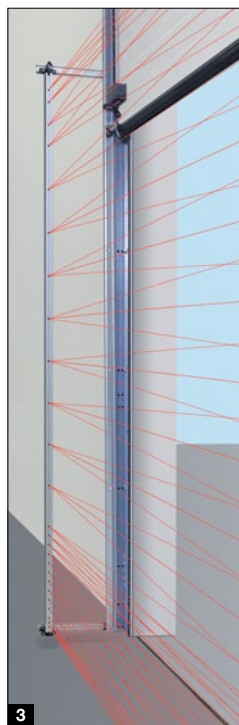
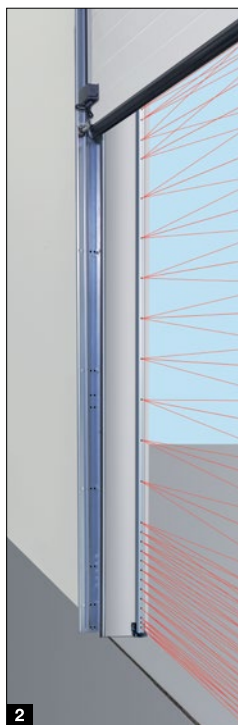
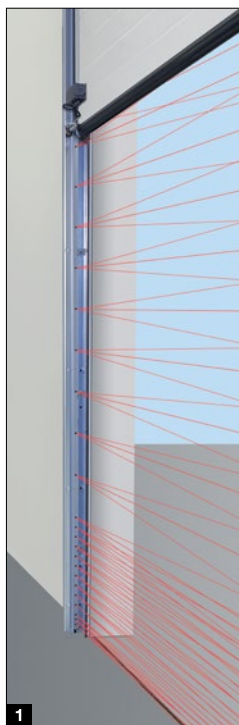



Reflection photocell RL 50 / RL 300
 Photocell with transmitter / receiver module and reflector; photocell tested by control before every downward movement; connection via system cable (RL 50, length 2 m) / 2-wire cable (RL 300, length 10 m); dimensions: 45 x 86 x 39 mm (W x H x D); protection category: IP 65; reflector range up to 8 m (standard); 30 x 60 mm (W x H), reflector range up to 12 m (not shown); 80 mm diameter; optional weather protective cover (not shown), anti-fog coating



One-way photocell EL 51
 Photocell with separate transmitter and receiver; the photocell is tested by the control prior to each downward movement; connection via system cable; max. range 8 m; dimensions with fitting bracket: 45 x 85 x 31 mm (W x H x D); protection category: IP 65; optional weather protective cover (not shown)

Photocells integrated in the door frame

EL 401 1

Fitting height 600 mm (property protection)

EL 501 2

Fitting height 125 mm (personal protection), cannot be combined with RC2 equipment

The two photocells can be ordered individually and combined for full protection.

- With separate transmitter and receiver
- The photocell is tested by the control prior to each downward movement
- Dimensions (W x H x D): Ø 25 mm
- Depth 55 mm
- Not in combination with VL1-LE, VL2-LE or HLG

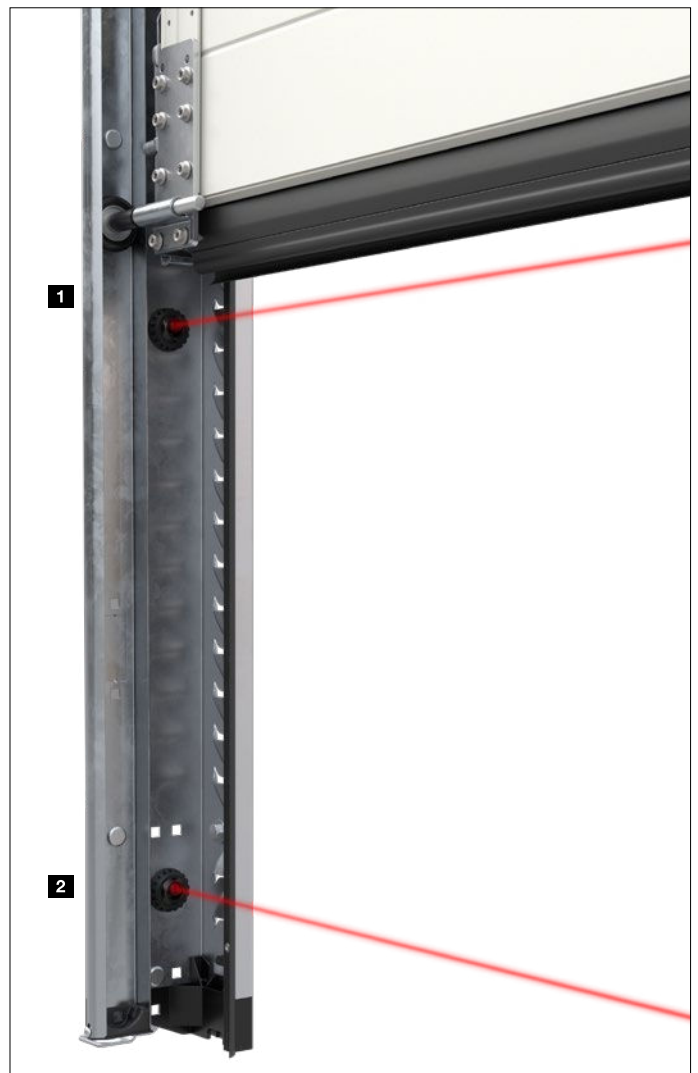

Accessories

Hand transmitter, radio switch, receiver



HS 5 BS
4 button functions,
plus query button,
high-gloss surface black or white



HS 5 BS
4 button functions,
plus query button,
textured surface matt black



HS 4 BS
4 button functions,
textured surface matt black



HS 1 BS
1 button function,
textured surface matt black



HSE 1 BS
1 button function,
including eyelet for key ring,
textured surface matt black



HSE 4 BS
4 button functions,
incl. eyelet for key ring,
textured surface matt black
with chrome or plastic caps



4-button security hand transmitter HSS 4 BS
Additional function: copy protection for hand transmitter coding,
with chrome caps



Only from Hörmann

Modern radio system

The bi-directional BiSecur radio system is based on future-oriented technology for the convenient and secure operation of industrial doors. The extremely secure BiSecur encryption protocol makes sure that no-one can copy your radio signal. It was tested and certified by security experts at Bochum university.

Your advantages

- 128-bit encryption with the same high security level as online banking
- Interference-resistant radio signal with a stable range
- Convenient querying of the door position*
- Backwards compatible, i.e. radio receivers with the frequency 868 MHz (2005 to June 2012) can also be operated with BiSecur control elements

* For WA 300 S4 with optional bi-directional receiver ESEi BS, for all other operators with optional bi-directional receiver HET-E2 24 BS and end-of-travel position feedback



Radio code switch FCT 3 BS
3 functions, with illuminated buttons, recessed or surface-mounted fitting possible, plastic housing in Light grey 7040 (also available with 10 functions and hinged cover, painted in White aluminium RAL 9006)



Radio code switch FCT 10 BS
10 functions, with illuminated buttons and hinged cover, recessed or surface-mounted fitting possible, plastic housing painted in RAL 9006 White aluminium



Radio finger-scan FFL 25 BS
2 functions and up to 25 fingerprints, with hinged cover, recessed and surface-mounted fitting possible, plastic housing painted in RAL 9006 White aluminium



Radio radar button FSR 1 BS
Sensor for non-contact opening, plastic housing, IP 41
For recessed and surface-mounted fitting

Radar button HTR 1-230 / 1-24
Wired version with 230 V or 24 V



Industrial hand transmitter
NEW. HSI 3 BS, HSI 6 BS, HSI 15 BS
For controlling up to 3 doors (HSI 3 BS), 6 doors (HSI 6 BS) or 15 doors (HSI 15 BS), with extra-large buttons for easier operation with work gloves, impact-resistant housing; protection category: IP 65



Industrial hand transmitter HSI BS
For controlling up to 1000 doors, with a display and extra-large quick selection buttons for easier operation with work gloves, transferring of hand transmitter coding to other devices possible, connection to external power supply via optional connection cable



3-channel receiver HEI 3 BS
For controlling 3 functions

Bi-directional receiver ESEi BS
For querying the door position



1-channel relay receiver HER 1 BS
1 volt-free relay output with status query



2-channel relay receiver HER 2 BS
2 volt-free relay outputs with status query and external antenna



2-channel relay receiver HET-E2 24 BS
2 volt-free relay outputs for choosing the direction, one 2-pin input for volt-free Open and Close limit switch reporting (for querying the door position)



4-channel relay receiver HER 4 BS
4 volt-free relay outputs with status query

Accessories

Button



Push button DTH-R / DTH-RM

Separate control of both operational directions; separate stop button, with miniature lock (DTH-RM only): Control of the operator is deactivated – operator movement is no longer possible (2 keys included in the scope of delivery)

Dimensions:
90 × 160 × 55 mm (W × H × D)
protection category: IP 65



Push button DTH-I / DTH-IM

To move the door into the OPEN / CLOSE positions, separate stop button to stop door travel, ½ Open button to open the door up to the programmed intermediate travel limit, with miniature lock (DTH-IM only): operator control is deactivated, operator movement is no longer possible (2 keys included in the scope of delivery)

Dimensions:
90 × 160 × 55 mm (W × H × D)
protection category: IP 65

Note:
With integrated control WA 300 S4, only in combination with UAP 1-300, not for control 545



Push button DTP 02

Opening or closing via a command button, separate stop button, operation control light for control voltage, lockable with profile half cylinder (available as an accessory)

Dimensions:
77 × 235 × 70 mm (W × H × D),
protection category: IP 44

Note:
The lockable function serves to isolate the control voltage and immobilises the command units. Profile half cylinders are not included in the scope of delivery for the push buttons.



Push button DTP 03

For separate control of both operational directions, separate stop button, operation control light for control voltage, lockable with profile half cylinder (available as an accessory)

Dimensions:
77 × 270 × 70 mm (W × H × D),
protection category: IP 44



Key switch ESU 30

with 3 keys, recessed version, Impulse or Open / Close functions selectable;

dimensions of the switch box:
60 mm (d), 58 mm (D),
dimensions of the panel:
90 × 100 mm (W × H),
brickwork recess:
65 mm (d), 60 mm (D);
Protection category: IP 54

Surface-mounted version ESA 30

(not shown)
Dimensions:
73 × 73 × 50 mm (W × H × D)



Key switch STAP 50

with 3 keys, surface-mounted version

Dimensions:
80 × 80 × 63 mm (W × H × D);
Protection category: IP 54

Key switch STUP 50

with 3 keys, recessed version (not shown)

Dimensions:
80 × 80 mm (W × H);
Protection category: IP 54



Pull switch ZT 2 with cord

Impulse transmission to open or close the door

Dimensions:
60 × 90 × 55 mm (W × H × D);
Length of pull cord: 3.2 m;
protection category: IP 65

Cantilever arm KA1 (not shown)

Extension 1680 – 3080 mm,
can be used with ZT 2

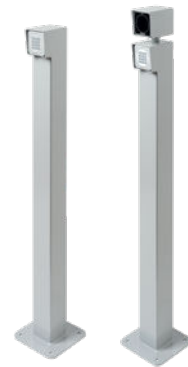

Posts

With a screw base for fitting to the floor, surface finish in White aluminium RAL 9006, 90 × 90 mm tube, also available as a set-in-concrete version

Post STN 1

To hold 1 command unit on the surface, height 1050 mm

Post STN 1-1

To hold 2 command units or 1 command unit and 1 warning light, height 1200 mm

For command units:
CTR 1b-1, CTR 3b-1, CTV 3-1,
CTP 3-1, TTR 1000-1, FL 150,
STUP 50, LED double warning lights red / green



**Code switch CTR 1b-1,
CTR 3b-1**

For 1 (CTR 1b-1) or 3 (CTR 3b-1)
functions, with illuminated buttons

Dimensions:
80 × 80 × 15 mm (W × H × D)



Code switch CTV 3-1

For 3 functions, with particularly
robust metal keypad

Dimensions:
80 × 80 × 15 mm (W × H × D)



Code switch CTP 3

For 3 functions, with illuminated
lettering and touch-sensitive
surface

Dimensions:
80 × 80 × 15 mm (W × H × D)



Decoder housing

For code switches CTR 1b-1,
CTR 3b-1, CTV 3-1, CTP 3

Dimensions:
140 × 130 × 50 mm (W × H × D),
Switching capacity: 2.5 A / 30 V DC
500 W / 250 V AC



Finger-scan FL 150

For 2 functions, up to 150
fingerprints can be saved

Dimensions:
80 × 80 × 13 mm (W × H × D);
Decoder housing:
70 × 275 × 50 mm (W × H × D);
Switching capacity: 2.0 A / 30 V DC



**Radar movement detector
RBM 2**

For OPEN impulse with directional
recognition, max. fitting height:
6 m; optional remote control
for radar movement detector

Dimensions:
155 × 132 × 58 mm (W × H × D);
Contact load:
24 AC / DC, 1 A (resistivity);
protection category: IP 65



Transponder key switch TTR 1000-1

For 1 function via transponder key or transponder card,
up to 1000 keys or cards can be saved

Dimensions: 80 × 80 × 15 mm (W × H × D);
Decoder housing: 140 × 130 × 50 mm (W × H × D);
Switching capacity: 2.5 A / 30 V DC; 500 W / 250 V AC



Accessories

Receivers, gateways



Bluetooth receiver HET-BLE

For operation, impulse sequence control of industrial sectional doors via the Hörmann BlueSecur app

Dimensions:
110 × 45 × 40 mm (W × H × D)



UAP 1-300

For WA 300 S4; impulse selection, partial opening function, limit switch reporting and activating kit for warning lights with 2 m system cable

Dimensions:
150 × 70 × 52 mm (W × H × D);
Max. switching capacity:
30 V DC / 2.5 A (resistivity),
250 V AC / 500 W (resistivity);
protection category: IP 65



HOR 1-300

For WA 250 R S4, WA 300 R S4 or control 300 to control limit switch reporting or warning lights with 2 m connecting lead; optionally available for fitting in push button control 300 U (not shown)

Dimensions:
110 × 45 × 40 mm (W × H × D);
Max. switching capacity:
30 V DC / 2.5 A (resistivity),
250 V AC / 500 W (resistivity);
protection category: IP 44



Loxone gateway (Hörmann Air)

For controls 545, 560 to control Hörmann operators and controls via the Loxone Smart Home control centre



KNX gateway

For controls 545, 560
To control Hörmann operators and controls via the KNX building automation



WiFi gateway

For controls 545, 560 (incl. HCP adapter), WA 300 S4 integrated control, SupraMatic HT to control Hörmann operators and controls via Apple Home, Amazon Alexa or Google Home / Google Assistant.



Homematic IP gateway

For WA 300 S4 integrated control, SupraMatic HT to control Hörmann operators via the Homematic IP Smart Home control centre



DeltaDore gateway (X3D gateway)

For WA 300 S4 integrated control, SupraMatic HT to control Hörmann operators via the DeltaDore Tydom Smart Home control centre



GSM Control

For controls 360, 445R, 460R, 545, 560 for opening of the system via telephone call and receipt of status or malfunction information via text messages



Widescan

Thanks to laser technology, the high-end motion detector and monitoring system guarantees operational safety, even with different floor coverings. The laser field acts as a reliable door monitor. It detects how fast and in which direction the object is travelling, ensuring optimum opening and closing response times. This minimises a door's hold time and saves energy.

- Also suited for outdoor areas as it is not susceptible to adverse weather conditions **1**
- Reliable advance protection, as well as fast and targeted automatic door opening
- Full door opening for vehicles with a height of min. 2400 mm*
- Energy-saving partial opening with adjustable opening height for vehicles with a height of max. 2400 mm* **2**
- Minimises the hold time of the door to save energy **3**
- Easy to hide objects permanently or temporarily in the detection range **4**
- Deactivation of cross-traffic and pedestrian traffic **5**
- Virtual pull switch enables door opening by people or vehicles standing at a defined position
- Visible LED spots on the floor assist during setup
- Easy connection to the operator control with plug-in wiring
- Bluetooth module for convenient configuration via app, e.g. with visualisation of the set field sizes in real-time

* Can be individually set if required

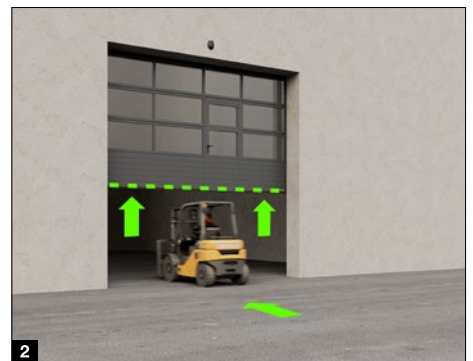

Accessories

Activating kits, LED traffic lights



Multi-function circuit board to be fitted in an existing housing or optionally in a separate extension housing (shown)

Limit switch reporting, momentary impulse, collective malfunction signalling, extension unit for controls

Extension housing with quick-release fastener
Dimensions: 202 × 164 × 130 mm (W × H × D);
protection category: IP 65

A circuit board can be optionally mounted in the control.



Digital weekly timer in a separate additional housing

The timer can switch command units on and off via a volt-free contact; extension unit for controls (for fitting in an existing housing)
Switching capacity: 230 V AC 2.5 A / 500 W, can be switched over to summer / winter time, manual switching: automatic operation, switching preselection permanently ON / OFF

Extension housing with quick-release fastener
Dimensions: 202 × 164 × 130 mm (W × H × D);
protection category: IP 65



Summer / winter activating kit in additional housing

Function for full door opening and individually programmable intermediate travel limit, extension unit for controls

Extension housing with quick-release fastener
Dimensions: 202 × 164 × 130 mm (W × H × D);
protection category: IP 65



DI 1 induction loop in a separate additional housing

Suitable for one induction loop, induction loop detector with a normally open contact and a change-over contact

DI 2 induction loop (not shown) in a separate additional housing, suitable for two separate induction loops, induction loop detector with two volt-free closing contacts, can be set for impulse or permanent contact, directional recognition possible

Extension housing with quick-release fastener
Dimensions: 202 × 164 × 130 mm (W × H × D);
Switching capacity:
DI 1: low voltage 2 A, 125 V A / 60 W;
DI 2: 250 V AC, 4 A, 1000 VA (resistive load AC);
Supplied without loop cable

Loop cable for induction loop: 50 m roll, cable designation: SIAF, cross-section: 1.5 mm², colour: brown



Activating kit for warning lights for fitting in an existing housing or optionally in a separate extension housing (shown)

Incl. 2 LED traffic lights TL40S ye; extension unit for control, with activating kit for warning lights as a visual indicator during door travel (weekly timer optional);

Applications: approach warning, automatic timer

After the set hold-open phase has elapsed (0 – 480 s), the warning lights flash during the set pre-warning time (0 – 70 s).

Extension housing with quick-release fastener
 Dimensions: 202 x 164 x 130 mm (W x H x D),
 contact load: 250 V AC; 2.5 A / 500 W;
 protection category: IP 65



Traffic control in a separate additional housing or for fitting in an existing housing (only for controls 360, 560)

incl. 2 LED traffic lights TL40S rd / gn or 2 LED traffic lights TL40S rd / ye* / gn; extension unit for control, with activating kit for warning lights as a visual indicator for regulating the entrance and exit (optional weekly timer); duration of the green phase: adjustable from 0 – 480 s, duration of the clearance phase: adjustable from 0 – 70 s

Extension housing with quick-release fastener
 Dimensions: 202 x 164 x 130 mm (W x H x D),
 contact load: 250 V AC; 2.5 A / 500 W;
 protection category: IP 65

* Yellow is not required for traffic control



LED traffic light TL40S rd

1-light, red,
 supply voltage
 100 – 240 V AC / 50 – 60 Hz
 Nominal power approx. 2 W
 Protection category: IP 65

Dimensions:
 180 x 250 x 290 mm
 (W x H x D)

LED traffic light TL40S ye

1-light, yellow,
 supply voltage
 100 – 240 V AC / 50 – 60 Hz
 Nominal power approx. 2 W
 Protection category: IP 65

Dimensions:
 180 x 250 x 290 mm
 (W x H x D)

LED traffic light TL40S gn

1-light, green,
 supply voltage
 100 – 240 V AC / 50 – 60 Hz
 Nominal power approx. 2 W
 Protection category: IP 65

Dimensions:
 180 x 250 x 290 mm
 (W x H x D)

LED traffic light TL40S rd / gn

2-light, red / green,
 supply voltage
 100 – 240 V AC / 50 – 60 Hz
 Nominal power approx. 2 W
 Protection category: IP 65

Dimensions:
 180 x 467 x 290 mm
 (W x H x D)

LED traffic light TL40S rd / ye / gn

1-light,
 red / yellow / green,
 supply voltage 24 V DC
 Nominal power approx. 2 W
 Protection category: IP 65

Dimensions:
 180 x 250 x 290 mm
 (W x H x D)

Performance characteristics

acc. to EN 13241

Door types	SPU F42	SPU 67 Thermo	APU F42	APU F42 Thermo	APU 67 Thermo	ALR F42	ALR F42 Thermo	ALR 67 Thermo
Wind load	Class according to EN 12424							
Door without wicket door	3 ²⁾ / 4 ^{1, 2)}	3 ²⁾ / 4 ^{1, 2)}	3 / 4 ¹⁾	3 / 4 ¹⁾	3 / 4 ¹⁾	3 / 4 ¹⁾	3 / 4 ¹⁾	3 / 4 ¹⁾
Door with wicket door	2 ²⁾ / 3 ^{1, 2)}	2 ²⁾ / 3 ^{1, 2)}	2 / 3 ¹⁾	2 / 3 ¹⁾	2 / 3 ¹⁾	2 / 3 ¹⁾	2 / 3 ¹⁾	2 / 3 ¹⁾
Water tightness	Class according to EN 12425							
Door without / with wicket door	3 (70 Pa)	3 (70 Pa)	3 (70 Pa)	3 (70 Pa)	3 (70 Pa)	3 (70 Pa)	3 (70 Pa)	3 (70 Pa)
Air permeability	Class according to EN 12426							
Door without wicket door	2 / 3 ^{3, 5, 6, 7)}	2 / 4 ^{3, 5, 6, 7)}	2	2	2 / 3 ^{5, 6, 7)}	2	2	2 / 3 ⁵⁾
Door with wicket door	1	1	1	1	1	1	1	1
Acoustic insulation³⁾	R [db] according to EN ISO 717-1							
Door without wicket door	25 ³⁾	25 ³⁾	23	23	23	23 / 30 ⁴⁾	23 / 30 ⁴⁾	23 / 30 ⁴⁾
Door with wicket door	24 ³⁾	24 ³⁾	22	22	22	22 / 29 ⁴⁾	22 / 29 ⁴⁾	22 / 29 ⁴⁾
Thermal insulation	U-value = W/(m ² ·K) according to EN 13241, Appendix B, for a door surface of 5000 × 5000 mm							
Door without / with wicket door								
Fitted door	1.0 / 1.2	0.62 / 0.82						
With ThermoFrame	0.94 / 1.2	0.51 / 0.75						
Synthetic double panes			3.4 / 3.6	2.9 / 3.1		3.6 / 3.8	3.0 / 3.2	
With ThermoFrame			3.3 / 3.6	2.8 / 3.1		3.6 / 3.8	3.0 / 3.2	
Synthetic triple panes			3.0 / 3.2	2.5 / 2.7	2.1 / 2.3	3.2 / 3.4	2.6 / 2.8	2.2 / 2.4
With ThermoFrame			2.9 / 3.1	2.4 / 2.6	2.0 / 2.2	3.1 / 3.4	2.5 / 2.8	2.1 / 2.3
Synthetic quadruple pane					1.8 / 2.0			1.9 / 2.1
With ThermoFrame					1.7 / 1.9			1.8 / 2.1
Double climatic pane			2.5 / 2.7	2.0 / 2.2	1.6 / 1.8	2.7 / 2.9	2.1 / 2.3	1.7 / 1.9
With ThermoFrame			2.4 / 2.6	1.9 / 2.1	1.5 / 1.7	2.6 / 2.8	2.0 / 2.2	1.6 / 1.8
Double real glass pane			3.4 / 3.6	2.9 / 3.1	2.6 / 2.8	3.6 / 3.8	3.0 / 3.2	2.7 / 2.9
With ThermoFrame			3.3 / 3.6	2.8 / 3.0	2.5 / 2.7	3.6 / 3.8	3.0 / 3.2	2.6 / 2.8
Single real glass pane								
With ThermoFrame								
PU sandwich infill								
With ThermoFrame								
¹⁾ For door widths up to 4000 mm								
²⁾ Lower class rating may apply for doors with compound window								
³⁾ For doors without glazing frame								
⁴⁾ Information refers to acoustic insulation value with real glass pane (optional)								
⁵⁾ With ThermoFrame								
⁶⁾ with optional increased air-tightness set								
⁷⁾ Only for Micrograin surface finish								
Side doors	NT 60 for SPU	NT 60 for APU	NT 60 for ALR	NT 60 for ALR Vitraplan	NT 80 Thermo for SPU	NT 80 Thermo for APU	NT 80 Thermo for ALR	
Wind load	3C	3C	3C	3C	4C	4C	4C	
Class according to EN 12424								
Air permeability	3	3	3	3	3	3	3	
Class according to EN 12426								
Water tightness under heavy rain	1 A	1 A	1 A	1 A	1 A	1 A	1 A	
Unprotected, opening outwards								
Thermal insulation	2,9	4,2	4,7	4,7	1,6	2,2	2,4	
U-value = W/(m ² ·K) according to EN 13241, Appendix B, for a door size of 1250 × 2200 mm								

ALR F42 Glazing	ALR F67 Thermo Glazing	ALR F42 Vitraplan	ALR F42 Vitraplan AT	Glazings / infills	U _g value W/(m ² ·K)	τ _v value %	g value %
3 / 4 ¹⁾	3 / 4 ¹⁾	3 / 4 ¹⁾	3 / 4 ¹⁾	Synthetic panes			
				Single pane, 3 mm			
				Clear		88	
				Crystal structure		84	
				Double pane, 26 mm			
3 (70 Pa)	3 (70 Pa)	3 (70 Pa)	3 (70 Pa)	Clear	2,6	77	74
				Crystal structure	2,6	77	74
				Grey tinted	2,6	3	28
				White tinted (opal)	2,6	69	69
				Triple pane, 26 mm			
2	2 / 3 ⁹⁾	2	2	Clear	1,9	68	67
				Crystal structure	1,9	68	67
				Grey tinted	1,9	3	25
				White tinted (opal)	1,9	61	63
				Triple pane, 51 mm			
				Clear	1,6	68	67
				Crystal structure	1,6	68	67
				Grey tinted	1,6	3	25
				White tinted (opal)	1,6	61	63
				Quadruple pane, 51 mm			
				Clear	1,3	60	61
				Crystal structure	1,3	60	61
				Grey tinted	1,3	2	23
				White tinted (opal)	1,3	54	58
				Polycarbonate panes			
				Single pane, 6 mm			
				Clear	-	-	-
				Double pane, 26 mm			
				Clear	2,7	81	75
				Triple pane, 51 mm			
				Clear	1,6	70	67
				Quadruple pane, 51 mm			
				Clear	1,3	61	61
				Real glass panes			
				Single pane, 6 mm			
				Clear	5,7	88	79
				Double pane, 26 mm			
				Clear	2,7	81	76
				Double climatic pane, 26 mm			
				Clear	1,1	80	64
				Infill			
				Multiple-moulded pane	1,9	57	62

Vitraplan attachments on request

U_g value Thermal insulation value
τ_v value Light transmittance (transparency)
g value Total energy transmittance

Construction and quality features

acc. to EN 13241

	SPU F42	SPU 67 Thermo	APU F42	APU F42 Thermo	APU 67 Thermo
Construction					
Self-supporting	●	●	●	●	●
Depth, mm	42	67	42	42	67
Door sizes					
Max. width mm, LZ	8000	10000	8000	7000	10000
Max. height mm, RM	7500	7500	7500	7500	7500
Material, door leaf					
Double-skinned steel section	●	-	●	●	-
Double-skinned steel section with thermal break	-	●	-	-	●
Aluminium profile	-	-	●	-	-
Aluminium profile, with thermal break	-	-	-	●	●
Surface, door leaf					
Galvanized steel with high-quality coating in RAL 9002	●	●	○	○	○
Galvanized steel with high-quality coating in RAL 9006	○	○	●	●	●
Galvanized steel with high-quality coating in RAL to choose	○	○	○	○	○
Anodised aluminium E6 / C0	-	-	●	●	●
Aluminium with high-quality coating in RAL to choose	-	-	○	○	○
Aluminium with high-quality coating in RAL 9005	-	-	-	-	-
Wicket door					
	○	○	○	○	○
Side doors					
Side door NT 60 matching the door	○	○	○	○	○
Side door NT 80 Thermo matching the door	○	○	○	○	○
Glazing					
Section window type A	○	○	-	-	-
Section window type D	○	○	-	-	-
Section window type E	○	-	-	-	-
NEW. Section window type F	○	○			
Aluminium glazing frame	○	○	●	●	●
Seals					
All-round on 4 sides	●	●	●	●	●
Intermediate seal between the door sections	●	●	●	●	●
ThermoFrame					
	○	○	○	○	○
Locking systems					
Inside locking	●	●	●	●	●
Outside / inside locking	○	○	○	○	○
Security features					
Anti-lift kit	●	●	●	●	●
RC2 security features	○	○			
Safety features in acc. with EN 13241					
Finger trap protection	●	-	●	●	-
Side trap guard	●	●	●	●	●
Safety catch for doors	●	●	●	●	●
Fastening options					
Concrete	●	●	●	●	●
Steel	●	●	●	●	●
Brickwork	●	●	●	●	●
Others on request					

● = As standard
○ = Optional

ALR F42	ALR F42 Thermo	ALR 67 Thermo	ALR F42 Glazing	ALR F67 Thermo Glazing	ALR F42 Vitraplan	ALR F42 Vitraplan AT
● 42	● 42	● 67	● 42	● 67	● 42	● 42
8000 7500	7000 7500	10000 7500	5500 4000	5500 4000	6000 7000	6000 7000
-	-	-	-	-	-	-
-	-	-	-	-	-	-
●	-	-	●	-	●	●
-	●	●	-	●	-	-
-	-	-	-	-	-	-
-	-	-	-	-	-	-
●	●	●	●	●	-	-
○	○	○	○	○	-	-
-	-	-	-	-	●	●
○	○	○	-	-	-	-
○	○	○	○	○	○	○
○	○	○	○	○	-	-
-	-	-	-	-	-	-
-	-	-	-	-	-	-
-	-	-	-	-	-	-
●	●	●	●	●	●	●
●	●	●	●	●	●	●
○	○	○	○	○	○	○
●	●	●	●	●	●	●
○	○	○	-	-	-	-
●	●	●	●	●	●	●
●	●	-	●	-	●	●
●	●	●	●	●	●	●
●	●	●	●	●	●	●
●	●	●	●	●	●	●

Everything from a single source for construction and industry

Our large product range offers the right solution for any requirement. All products are optimally adjusted to work together, ensuring high functional safety. This makes us a strong, future-oriented partner for industrial and public construction projects.

**INDUSTRIAL DOORS. LOADING TECHNOLOGY. SLIDING DOORS.
CONSTRUCTION PROJECT DOORS. PERIMETER PROTECTION SYSTEMS.**



Some of the products shown feature special equipment and do not always correspond to the standard versions. The surface finishes and colours shown are subject to the limitations of the printing process and cannot be regarded as binding. All RAL colours are based on the RAL colour chart. All rights reserved. No part may be reproduced without our prior permission. Subject to changes.