

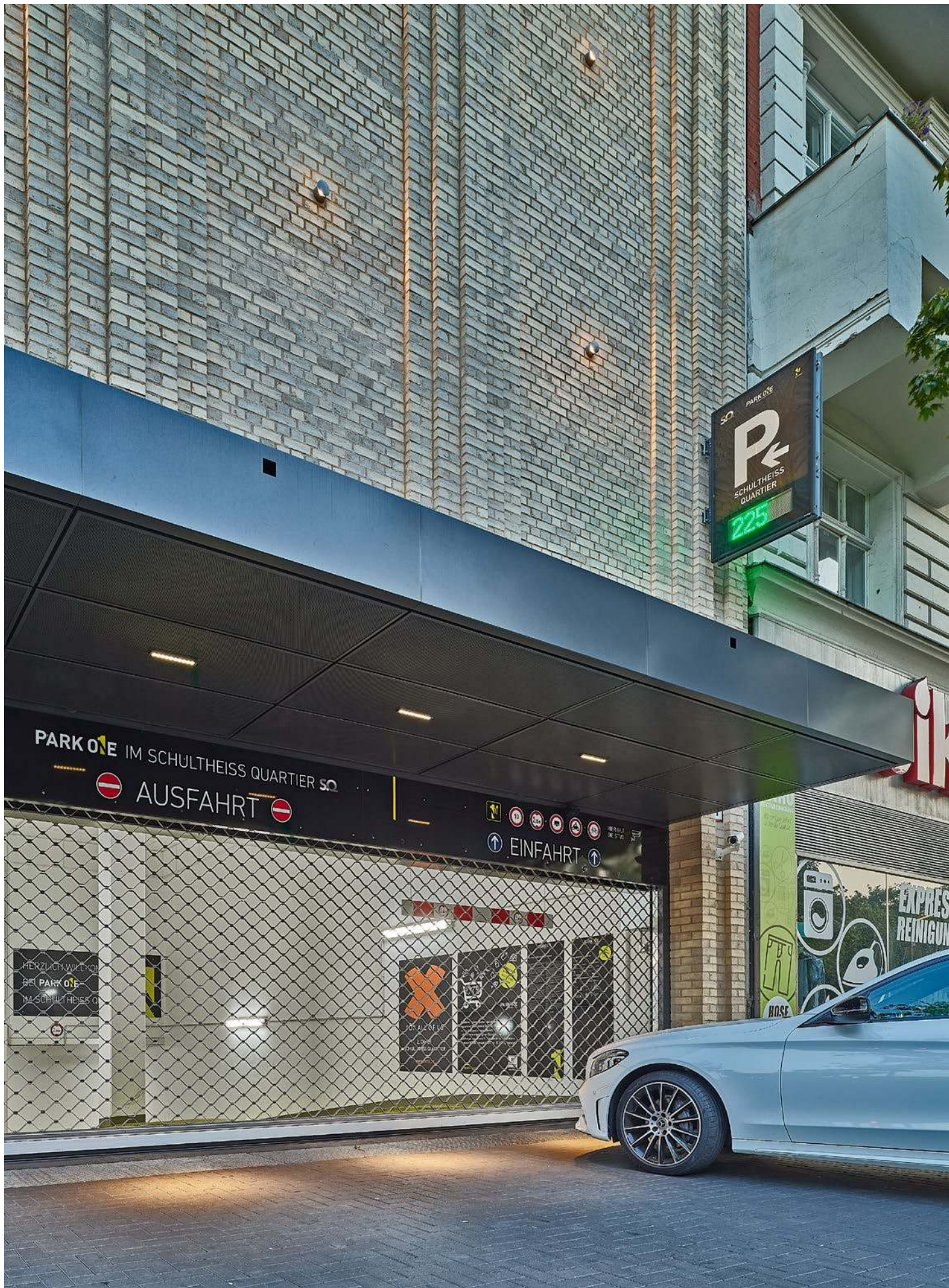

ROLLING SHUTTERS AND ROLLING GRILLES

NEW. Rolling shutter DD Decotherm S up to a door width of 12 m with wind load class 4

HÖRMANN





4

Good reasons
to try Hörmann

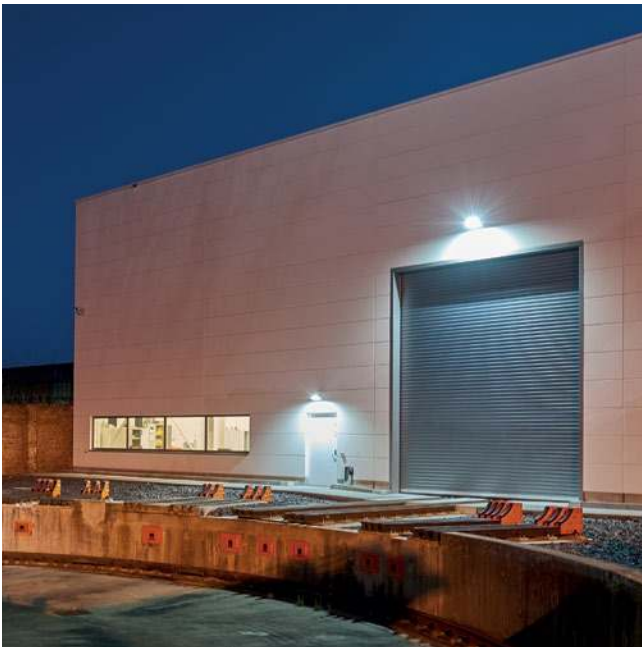

16

Application
areas



32

Versions
Accessories
Technology

Brand quality made in Germany



The family-owned company Hörmann offers all important construction components for building and renovating projects from a single source. We manufacture in highly specialised factories using state-of-the-art production technologies. Our employees work intensively on new products, continual further developments and improvements to details. The results are patents and unique products on the market.





WE THINK AND ACT GREEN. As a family business, we are very conscious of our responsibility to future generations and will offer all products for construction projects as CO₂-neutral versions upon customer request. In this way, customers have the option to offset remaining emissions and make a contribution to climate protection when purchasing our products. The Hörmann sustainability strategy aims to reduce and avoid emissions. We cover 100% of our electrical power needs at all European production sites with genuine green electricity from renewable sources. We also apply many other measures to reduce our consumption and save more than 75000 tonnes of CO₂ each year. We work with ClimatePartner to offset the remaining emissions by supporting certified climate protection projects.



You can find further information at www.hoermann.com/sustainability



ClimatePartner
certified product
climate-id.com/FYZNUF



CO₂
measure
reduce
contribute

Sustainable planning for trend-setting construction

Experienced specialists within our customer-oriented sales organisation accompany you from the planning stage, through technical clarification up to the final building inspection. Complete working documentation, such as technical manuals, is always accessible and up-to-date at www.hoermann.de





SUSTAINABILITY DOCUMENTED. Hörmann has already received confirmation of sustainability through an Environmental Product Declaration (EPD) in accordance with ISO 14025 from the Institut für Fenstertechnik (ift – Institute of window technology) in Rosenheim, Germany. This EPD was created based on EN ISO 14025:2011 and EN 15804:2012. In addition, the general guidelines for the preparation of type III Environmental Product Declaration apply. The declaration is based on the PCR document “Doors” PCRTT-1.1:2011.



PRODUCT PORTAL FOR ARCHITECTS AND PLANNERS.

Clearly structured navigation and a search function provide faster access to texts for invitations to tender, technical data, certificates, CAD drawings and much more. In addition, BIM data can be provided for many products for the Building Information Modelling process, enabling efficient planning, drafting, construction and management of buildings. Photos and photo-realistic presentations provide additional information on many products.



We are a member of the professional association for digital building products in the Federal Association of Building Systems e.V.



ENERGY SAVINGS COMPASS. Hörmann’s energy savings compass shows how industrial door systems and loading technology are planned with energy-efficiency and sustainability in mind. An integrated calculation module estimates the amortisation period for door and loading technology systems. The energy savings compass is available as a web-based interface for PC / Mac and mobile end devices.



Plan with the energy savings compass at:
www.hoermann.de/energy_savings_compass

Easy to fit and service

All door components are supplied ready to fit so that no adjustments are required on site. The fixing points are prepared for all components at the factory. This way, the doors can be fitted easily and without any errors in the shortest amount of time. This reduces fitting times and costs.





**Round-the-clock
service**

FAST SERVICE. Our teams of highly qualified specialists travel all around Germany. But Hörmann also offers consulting, maintenance and repairs in many other countries. Our network of over 500 service technicians guarantees speed and flexibility. We are available around the clock. Our customers can rely on us.



**10-year
guaranteed availability**

HÖRMANN SPARE PARTS. It goes without saying that spare parts for doors, operators, and controls are original Hörmann parts that come with a guaranteed availability of 10 years.



**Particularly easy
to fit and service**

EASIER INSTALLATION. The rolling shutters / rolling grilles SB and TGT are particularly easy to fit, as the standard power limit for most curtains and door sizes means that no closing edge safety device and lintel trap guard are required at the door. Due to the omission of sensors with a wear-prone coil cable on the door curtain, this door / operator construction is also very low-maintenance and cost-effective.

→ For further information, see from page 36.



The use of the operator WA 300 R S4 (shown on right) eliminates the need for the time-consuming fitting of a closing edge safety device and lintel trap guard on the door for a large number of doors.

Long-lasting design

All rolling shutter / rolling grille components are designed to have a long service life. For this purpose, the support brackets and barrels are supplied galvanized as standard and the side guides are made of high-quality aluminium. Long-lasting components are used down to the last detail. For example, the well thought-out design of the guide channel with particularly wide sliding surfaces on the rolling shutter DD, which also reduces door curtain wear.





CERTIFIED SAFETY. Hörmann rolling shutters and rolling grilles comply with the safety regulations of European standard 13241-1. For this reason, manually operated and power-driven doors work safely during all opening and closing phases. It pays to compare!



Tested and certified

HIGH-QUALITY COLOUR COATING. Coil-coated rolling shutter laths provide long-term protection against adverse weather effects for surface finishes. Additional protective paint with polyamide particles reduces abrasion.

→ For further information, see from page 53.

Permanently beautiful door appearance thanks to high-quality colour coating



Innovative tension spring assembly

Only from Hörmann

The rolling shutters / rolling grilles SB and TGT are characterised by a low-maintenance and economical operation. The tension spring assembly compensates for the curtain weight. When manually operated, this optimally supports opening and closing. For power-driven doors, the tension spring assembly reduces operator load and extends the service life of operator components.





SAFE AND DOOR-PROTECTING OPERATOR. The standard power limit in the OPEN and CLOSE directions ensures safe door operation, as the door stops reliably when encountering an obstacle. Thanks to the soft start and soft stop function of the door curtain, all door and operator components are protected from wear.

WELL THOUGHT-OUT DOOR CONSTRUCTION. The entire door construction, including support brackets and side guides, is fitted as a frame unit to the building structure. This reduces fitting time and thus costs. Thanks to the low sideroom of only 165 mm, the door can also be fitted easily in tight spaces. Plastic runners and brushes in the aluminium side guides ensure quiet door travel.

Systematic operator solutions

All operators and controls are optimally adjusted to work together, ensuring high functional safety of the door. The uniform operating concept with a 7-segment display ensures daily ease of use. In addition, housings and cable sets of the same size allow for easier fitting and ensure that all Hörmann industrial doors, loading technology, operators, controls and accessories work together optimally and efficiently.



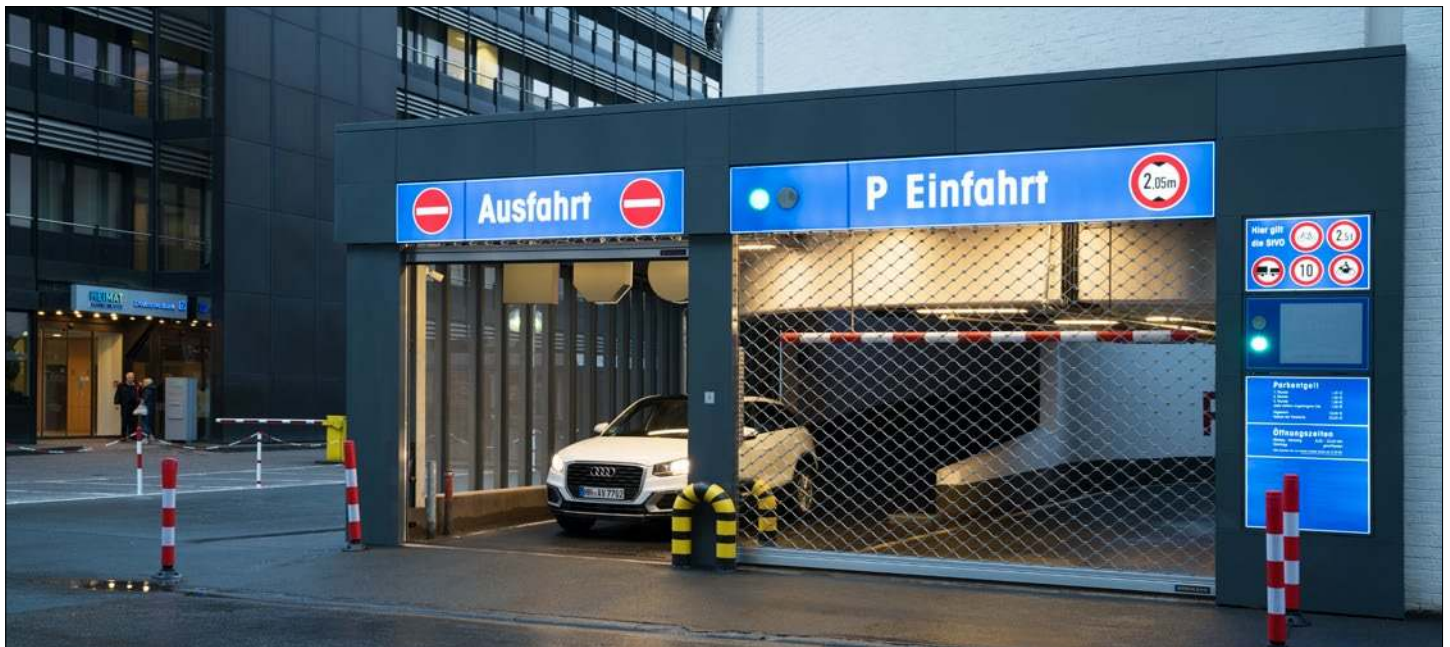

RELIABLE SECURITY. For doors with impulse sequence control, safety systems with integrated self-test monitor compliance with the specifications for dynamic closing forces. Power-driven rolling grilles in public, easily accessible areas also frequented by children, who could use the rising rolling grille to pull themselves up, are equipped with special safety equipment such as a lintel trap guard or a power limit in the OPEN direction.

QUICK DOOR OPENING. Optimise your operations and minimise heat loss with the optional accessory package S6 for the rolling shutter DD with Decotherm curtain. The door opens at up to 1.1 m/s, almost as fast as a high-speed door, but with significantly lower purchasing and operating costs. Thanks to the soft start and soft stop function, the door runs particularly gently, taking stress off the mechanical door elements, thus extending the service life of the door. A light grille in the travel area of the curtain offers a high level of safety.

→ For further information, see from page 50.





18

Shopping centre



20

Collective garages
and car parks



22

Logistics companies



24

Agricultural buildings



28

Commercial buildings
and warehouses



28

Industry and
production halls



30

Airports



Shopping centre

Rolling grilles offer 24/7 security for businesses or retail spaces within shopping centres. The elegant shop door ShopRoller SR with curtain, side guides and bottom profile made of anodised aluminium E6 / C-0 blends unobtrusively into the fitting environment. Four curtain versions and tested RC2 / RC3 variants offer an individual view and break-in-resistant security.



For further information on the shop door ShopRoller SR, see the brochure.





TOP LEFT. Shop door ShopRoller SR

TOP RIGHT. Rolling grille DD HG-L

BOTTOM. Rolling grille SB HG-L

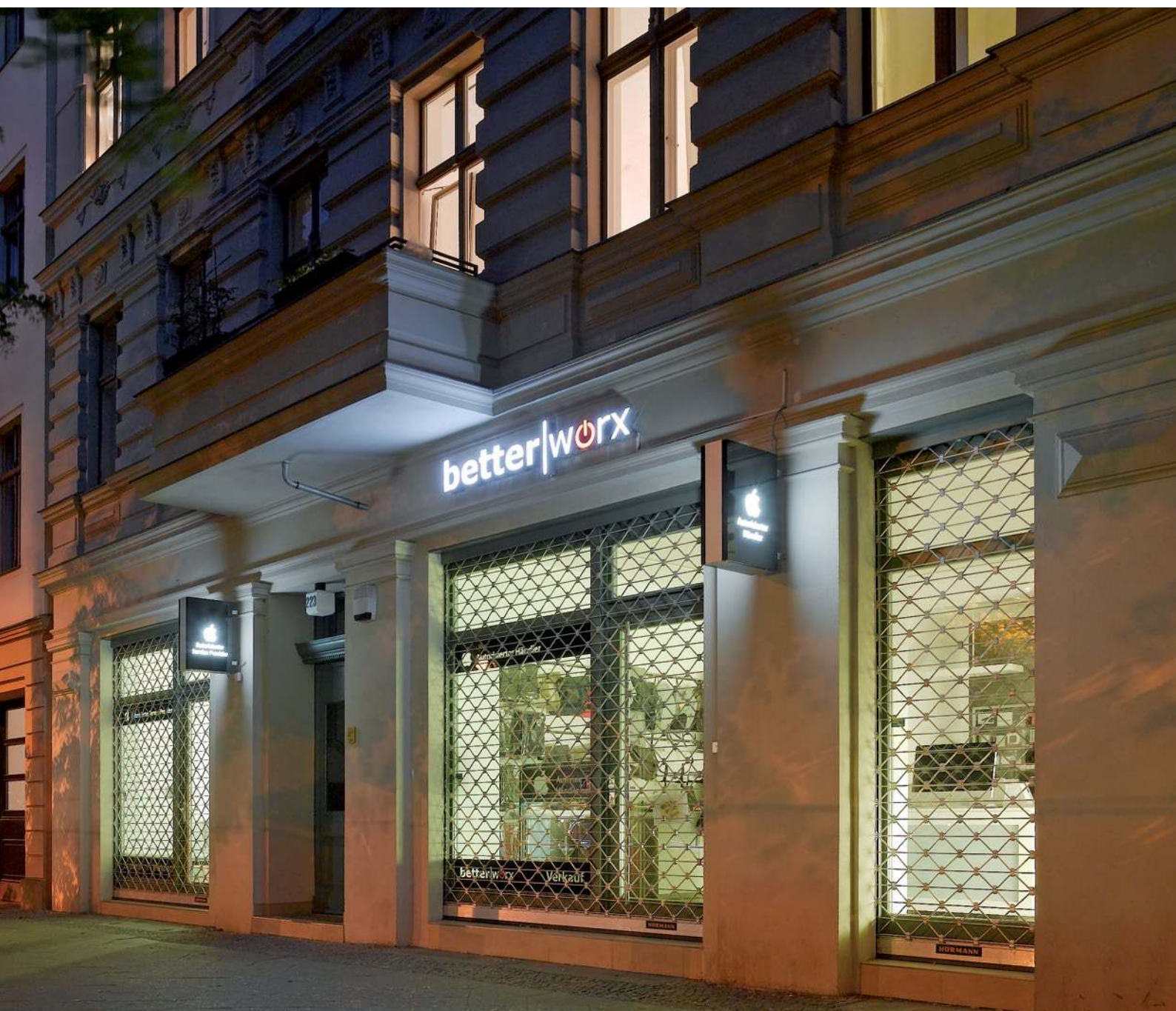

LEFT. Underground garage rolling grille
TGT HG-L with side door NT 60

TOP RIGHT. Rolling grille DD HG-L

BOTTOM RIGHT. Underground garage
rolling shutter TGT Decotherm S





Collective garages

The TGT underground garage rolling shutters / rolling grilles were developed to meet the special requirements of underground and collective garages. They are characterised by the standard soft start and soft stop functions of the operators and, in particular, by their smooth running. The compact design with low required headroom enables installation even in very tight spaces.

→ For further information on the TGT underground garage rolling shutters / rolling grilles, see from page 40.



TOP. Rolling shutter DD S6 Decotherm S

BOTTOM LEFT. Rolling shutter SB Decotherm S

BOTTOM RIGHT. Rolling shutter SB Decotherm S,
loading house and loading platform HRT
as well as flap dock shelter





Logistics

Hörmann rolling shutters and operators are optimally matched to Hörmann loading technology. You therefore receive logistics solutions that perfectly match your requirements in terms of thermal efficiency and functions. The high opening speed of the rolling shutter DD with the optional accessory package S6 reduces heat loss and optimises your operations.

→ For further information on the rolling shutters DD with the optional accessory package S6, see from page 50.



Agricultural buildings

For the tough everyday conditions in agricultural work, we recommend the affordable yet robust rolling shutters SB. The steel or aluminium curtains are available for door widths up to 5000 mm. The doors can be opened and closed by hand on the barrel side, as the tension spring assembly compensates for the door curtain weight.

→ For further information, see from page 34.





TOP. Rolling shutter DD Decotherm S

BOTTOM. Rolling shutter SB Decotherm S





Commercial buildings and warehouses

The convenient rolling shutter SB door solution offers a very cost-effective and low-maintenance operator thanks to the tension spring assembly used. The rolling shutter SB can be fitted as both an internal and external rolling shutter.

→ For further information, see from page 36.





TOP LEFT. Rolling shutter SB Decotherm S

TOP RIGHT. Rolling shutter SB Decotherm S (in the background) and rolling shutter DD Decotherm S (in the foreground)

BOTTOM. Rolling shutter SB Decotherm S



TOP LEFT. Rolling shutter DD S6 Decotherm S

TOP RIGHT. Rolling shutter DD Decotherm S

BOTTOM. Rolling shutter combination SSG DD Decotherm S





Industry and production halls

The innovative rolling shutters DD close door openings up to 12 m wide and 9 m high. Particularly large openings up to 36 m wide are closed efficiently by coupling two or three standard rolling shutters DD.

→ For further information, see from page 44.

Airports

With the rolling shutter / rolling grille combination SSG DD, you can connect up to 3 rolling shutters DD with mobile centre supports, enabling you to close door openings up to 36 m wide and 9 m high. To utilise the entire opening width, the centre supports are simply pushed to the side.

→ For further information, see from page 48.



TOP. Rolling shutter combination SSG DD, completely closed

BOTTOM LEFT. Rolling shutter combination SSG DD, one door open

BOTTOM RIGHT. Rolling shutter combination SSG DD, completely open







36



52



56



Versions Accessories Technology

- 34 Rolling shutter / rolling grille SB, manually operated solution
- 36 Rolling shutter / rolling grille SB, operator solutions
- 40 Underground garage rolling shutter / rolling grille TGT
- 44 Rolling shutter / rolling grille DD
- 48 Rolling shutter / rolling grille combination SSG DD
- 50 Rolling shutter / rolling grille DD S6
- 52 Rolling shutter laths and rolling grille curtains
- 53 Colours
- 54 Break-in resistance equipment
- 55 Glazing beads and ventilation laths, panels
- 56 Side doors
- 58 Controls
- 62 Accessories
- 70 Performance characteristics

Rolling shutter / rolling grille SB

Manually operated door solution



Simple manual operation

The manually operated rolling shutter / rolling grille SB is the inexpensive solution for low-frequency building openings. Thanks to the patented tension spring assembly, the door can be opened and closed manually from the barrel side. The door is operated via the interior handle.

Optional operator retrofitting

If an automatic door opening is subsequently required, an operator can be easily retrofitted to the rolling shutter / rolling grille SB.

Further information can be found on page 36.

Maximum door sizes

- Rolling shutter
width up to 5000 mm
height up to 4500 mm
- Rolling grille
width up to 6000 mm
height up to 4500 mm





Optional operation options

- Pull rod **1**
- Chain hoist **2**

Break-in-resistant locks

- Shootbolt **3**
- Lockable bottom profile **4**
- Automatic locking ETV-1 **5**

Wind locks and pull-out protection

These ensure that the curtains cannot be pushed out of the side guides by wind loads or in the event of vandalism.

Further information can be found on page 54.

Curtain variants

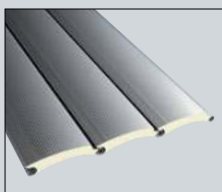

Decotherm S, steel
Max. door width: 5000 mm
Max. door height: 4500 mm

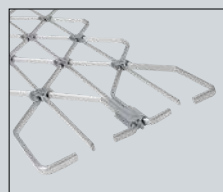

HG-L, aluminium
Max. door width: 6000 mm
Max. door height: 4500 mm

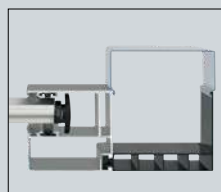

Plastic wind lock
as standard

For further information on the curtains,
see pages 52 – 53.

Rolling shutter / rolling grille SB

Convenient operator solutions

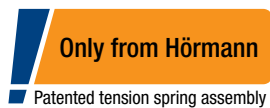

Soft start
Soft stop

Convenient door operation

The rolling shutter / rolling grille SB can also be equipped with an operator system that is optimally matched to the door technology. You can choose between the operator WA 300 R S4 with integrated control and the compact operator WA 300 AR S4 with a separate control unit. Further information can be found starting on page 38.

Gentle door travel

The operators feature a soft start and soft stop function of the door curtain as standard, which protects all door and operator components from wear.

Functions at a glance

- Low power consumption in standby of approx. 1 watt (if no other electrical accessories are connected)
- Functional extension possible with external control 360 (see page 58): traffic control (in combination with activating kit for warning light and photocell)

Maximum door sizes

- Rolling shutter
width up to 5000 mm
height up to 4500 mm
- Rolling grille
width up to 6000 mm
height up to 4500 mm





Well thought-out door construction

Thanks to the narrow side guides, the rolling shutter / rolling grille SB requires a sideroom of only 165 mm and can therefore be fitted easily in tight spaces. Furthermore, the convenient door solution offers very low-maintenance and cost-effective operation, as the curtain weight is ideally compensated for by the tension spring assembly and the entire door construction is protected from wear.

Protection from trapping 1

The spring chambers on the side guides are fitted with plastic covers as standard.

Power limit as standard 2

The power limit in the OPEN and CLOSE directions ensures safe door operation, as the door stops reliably when encountering an obstacle. In addition, it is particularly easy to fit, because most curtains and door sizes do not require a closing edge safety device and lintel trap guard at the door. Due to the omission of sensors with a wear-prone coil cable on the door curtain, this door / operator construction is also very low-maintenance and cost-effective.

Impulse operation without closing edge safety device

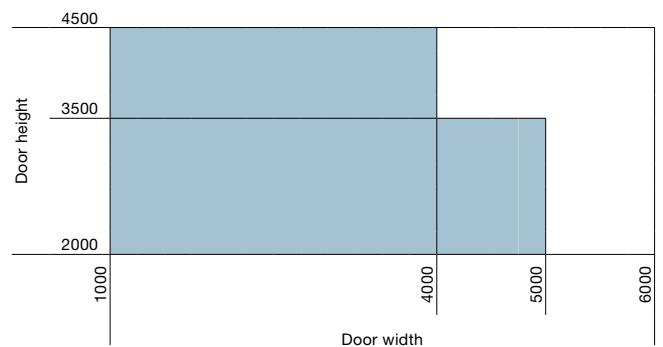

Rolling shutter / rolling grille SB

Convenient operator solutions



WA 300 R S4 ¹

- Automatic opening and closing after pressing the button (impulse operation)
- Automatic timer closing can be selected after 30, 60 or 90 seconds
- Integrated operator control
- Push button DTH-R ²
- Optional secured release on the inside ⁹ to release the operator at operating height

WA 300 AR S4 ⁴

- Ideal for discreetly fitting the door barrel and operator components in intermediate ceilings in shops, etc.
- Only 100 mm additional sideroom is required on the operator side
- Automatic opening and closing after pressing the button (impulse operation)
- Automatic timer closing can be selected after 30, 60 or 90 seconds
- Separate control unit 300 ⁵
- Quick and convenient setting of the end-of-travel positions and control parameters at operating height
- Secured release on the inside as standard ⁹ to release the operator at operating height

Optional cladding

For effective protection against reaching into the door barrel as well as against dirt and adverse weather effects, optional cladding is available for the door barrel and operator ³ ⁶.

Robust trap guard

The spring chambers on the side guides can be optionally equipped with robust aluminium covers ⁷.

Protection against dirt

The so-called "marten protection" ⁸ is available in a height of 640 mm.



7



8



9



10

Emergency release from the outside

With the optional secured release from the outside ASE **10** in a lockable die-cast housing with a profile half-cylinder, the operators can be decoupled and the doors opened or closed by hand in the event of a power failure, for example. Dimensions: 83 × 133 × 50 mm (W × H × D)

Wind locks and pull-out protection

These ensure that the curtains cannot be pushed out of the side guides by wind loads or in the event of vandalism.

Curtain variants

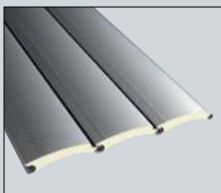

Decotherm S, steel
Max. door width: 5000 mm
Max. door height: 4500 mm

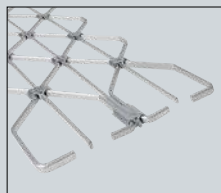

HG-L, aluminium
Max. door width: 6000 mm
Max. door height: 4500 mm

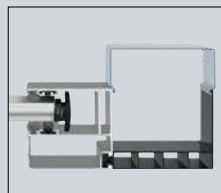

Plastic wind lock
as standard

For further information on the curtains, see pages 52 – 53.

Underground garage rolling shutter / rolling grille TGT

Compact door solution for collective garages



Soft start
Soft stop

Matched system

The underground garage rolling shutter / rolling grille TGT is equipped with an operator system as standard and is optimally designed for the requirements of underground and collective garages. Thanks to the standard soft start and soft stop function of the door curtain, all door and operator components are also protected from wear.

Functions at a glance

- Low power consumption in standby of approx. 1 watt (if no other electrical accessories are connected)
- Functional extension possible with external control 360 (see page 58): traffic control in combination with activating kit for warning light and photocell

Maximum door sizes

- Rolling shutter
width up to 5000 mm
height up to 2400 mm
- Rolling grille
width up to 6000 mm
height up to 2400 mm





Compact design

The door construction specifically developed for the requirements of underground and collective garages with standard curtain cover is designed for an overall service life of 200000 door cycles* (Open / Close). Due to this compact design, the rolling grille, for example, features a required headroom of only 350 mm.

Protection from trapping 1

The spring chambers on the side guides are fitted with plastic covers as standard.

Note:

Compliance with the acoustic rating requirements in accordance with DIN 4109 depends on the acoustic planning and design of the building structure.

* With regular maintenance including replacement of wearing parts, e.g. spring assemblies at a rate of 40000 cycles

Power limit as standard 2 in all door sizes

The power limit in the OPEN and CLOSE directions ensures safe door operation, as the door stops reliably when encountering an obstacle. In addition, it is particularly easy to fit, because all curtains and door sizes do not require a closing edge safety device and lintel trap guard at the door. Due to the omission of sensors with a wear-prone coil cable on the door curtain, this door / operator construction is also very low-maintenance and cost-effective.

■ Impulse operation without closing edge safety device

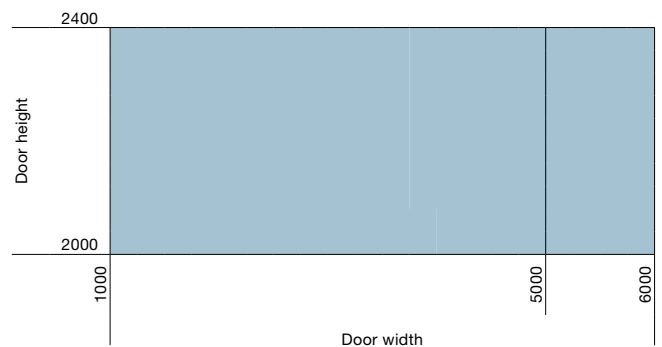

Underground garage rolling shutter / rolling grille TGT

Compact door solution for collective garages

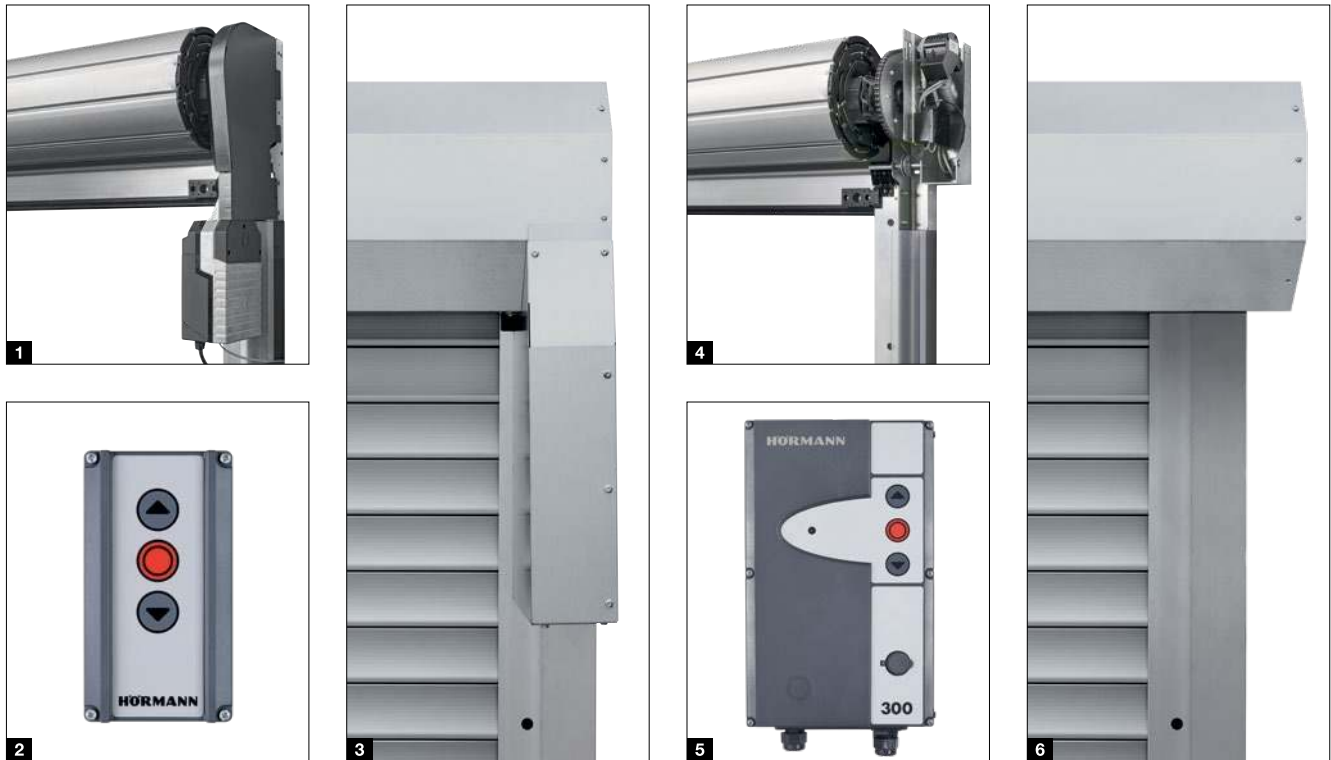

WA 300 R S4 1

- Automatic opening and closing after pressing the button (impulse operation)
- Automatic timer closing can be selected after 30, 60 or 90 seconds
- Integrated operator control
- Push button DTH-R 2

WA 300 AR S4 4

- Ideally suited for fitting situations with driveways in front of the door, as no operator components are fitted beneath the door barrel
- Only 100 mm additional sideroom is required on the operator side
- Automatic opening and closing after pressing the button (impulse operation)
- Automatic timer closing can be selected after 30, 60 or 90 seconds
- Separate control unit 300 5
- Quick and convenient setting of the end-of-travel positions and control parameters at operating height

Permanent protection

The galvanized sheet steel claddings 3 6 are fitted directly to the door construction and protect the operator as well as the curtain.

Emergency release from inside

For emergency operation, e.g. in the event of a power failure, all operators can be easily switched to manual operation at operating height using the standard secured release on the inside 7.

Emergency release from the outside

With the optional secured release from the outside ASE 8 in a lockable die-cast housing with a profile half-cylinder, the operators can be decoupled and the doors opened or closed by hand in the event of a power failure, for example. Dimensions: 83 × 133 × 50 mm (W × H × D)



Robust trap guard

The spring chambers on the side guides can be optionally equipped with robust aluminium covers **9**.

Protection against dirt

The so-called “marten protection” **10** is available in a height of 640 mm.

Wind locks and pull-out protection

These ensure that the curtains cannot be pushed out of the side guides by wind loads or in the event of vandalism.

Curtain variants

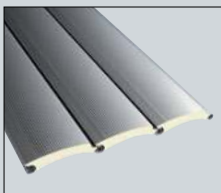

Decotherm S, steel
Max. door width: 5000 mm
Max. door height: 2400 mm

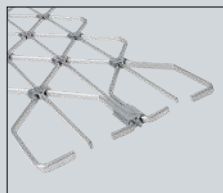

HG-L, aluminium
Max. door width: 6000 mm
Max. door height: 2400 mm

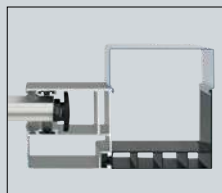

Plastic wind lock
as standard

For further information on the curtains, see pages 52 – 53.

Rolling shutter / rolling grille DD

Small fitting dimensions and convenient fitting

Powerful operator and control system

This universal door solution features a high-performance direct drive operator and variable operator fitting.

Easy fitting

The side guides are easily aligned and fitted using a metre line. The curtain, winding shaft and support brackets are pre-assembled as a unit and are positioned and attached to the building structure using support bracket templates. Markings on the side guides are used to quickly set the top end-of-travel position. The stackable packaging units also optimise transport and logistics to the construction site.

Maximum door sizes

- Rolling shutter
width up to 12000 mm
height up to 9000 mm
- Rolling grille
width up to 12000 mm
height up to 8000 mm





Narrow aluminium side guide

The side guides require a sideroom of only 80 mm for all door sizes **1**. For better handling during transport and fitting, the side guides are delivered as a 2-part version from a door height of 6000 mm.

Optimal distance to the building structure

For a better front bracket, the support profiles **2** increase the distance between the side guides and the building structure. The support profiles made of aluminium form an elegant unit with the side guides.

Gentle door inlet

The standard guide channel **3** with polyamide sliding surfaces reduces wear of the door curtain. The metal holder can be replaced very easily for inspection and maintenance.

Compact support brackets

Even with large door dimensions, the support brackets only require a sideroom of max. 180 mm (bearing side) or max. 280 mm (operator side).

Flexible fitting

The side guides are quickly and easily fitted directly on the building structure. The optional steel bracket fastening **4** allows fitting to insulated building openings or fitting by welding in steel construction.

Rolling shutter / rolling grille DD

Flexibility and easy fitting

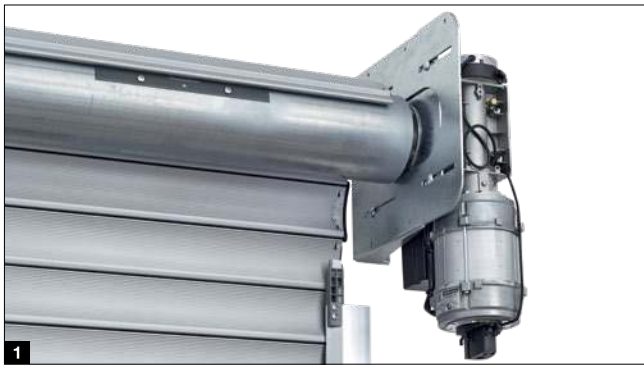

Direct drive operator

- Powerful direct drive operator with absolute encoder (AWG) for a reliable door operation
- Integrated position-independent catch safety device prevents the door curtain from falling
- With the horizontal alignment, no operator technology is visible underneath the barrel

Variable operator fitting

The fitting position of the operator can be freely selected during fitting and thus optimally adapted to the respective fitting situation on-site.

1 Towards bottom

2 Horizontal

Optional curtain and operator cover

- Protection of the door barrel from dirt and adverse weather effects with curtain cover PVDD **3**
- As trap guard for doors with a door height of up to 2500 mm (required according to EN 13241-1)
- Can be expanded with operator cover VDD **4** for both operator positions
- Made of galvanized sheet steel
- Quick and easy fitting thanks to fixing to the door brackets

Curtain variants

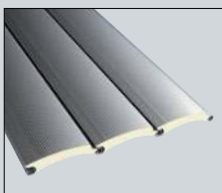

Decotherm S, steel
Max. door width: 12000 mm
Max. door height: 9000 mm

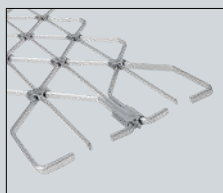

HG-L, aluminium
Max. door width: 9000 mm
Max. door height: 5500 mm



HG-V, aluminium (reinforced)
Max. door width: 12000 mm
Max. door height: 8000 mm

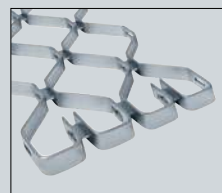

HG-S, steel
Max. door width: 12000 mm
Max. door height: 8000 mm

For further information
on the curtains,
see pages 52 – 53.

Rolling shutter DD Decotherm S with performance package W4

NEW. Wind load class 4 up to a door width of 12 m

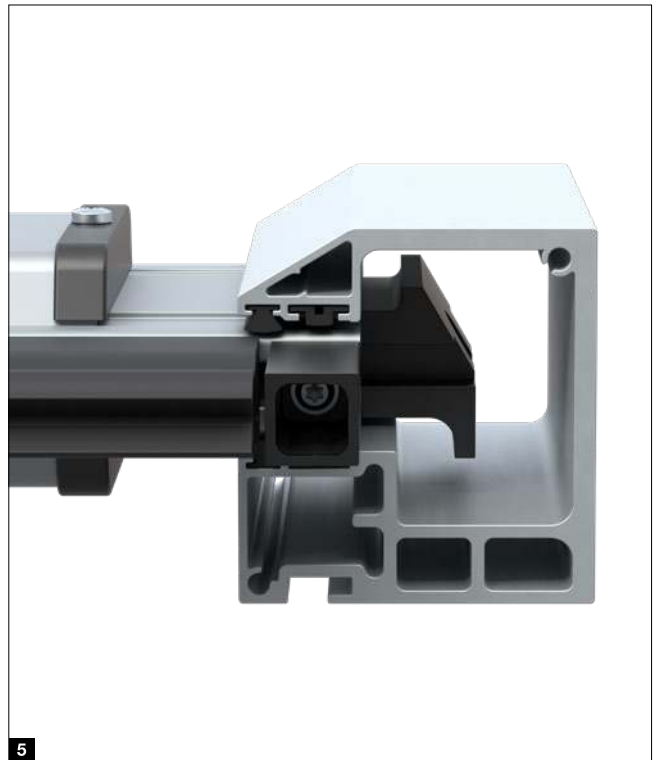

NEW. Performance package W4 5

The rolling shutter DD Decotherm S with the new performance package W4 offers the maximum wind load class 4 up to a door width of 12000 mm. The performance package W4 is characterised by optimally matched components such as innovative wind locks, reinforced side guides and specially selected fixing materials.



Plastic wind lock (rolling shutter) as standard



Steel wind lock from a door width of 7500 mm (rolling shutter) as standard



Wind lock W4 (rolling shutter)



Plastic pull-out protection (rolling grille) as standard

Rolling shutter / rolling grille combination SSG DD

For large openings of up to 36 m wide or 9 m high

Economical combination

This door combination allows for particularly large openings to be closed conveniently and economically by coupling two or three standard rolling shutters DD or rolling grilles DD. In addition, this door combination is particularly economical to purchase, transport, fit and service.

Variable door openings

For use of the complete opening width, the doors are opened and the centre support is then unlocked and pushed to the side.

The doors can also be controlled individually. In this case, the smaller door openings significantly reduce energy loss.

Maximum opening sizes

- Rolling shutter
width up to 36000 mm
height up to 9000 mm
- Rolling grille
width up to 36000 mm
height up to 8000 mm



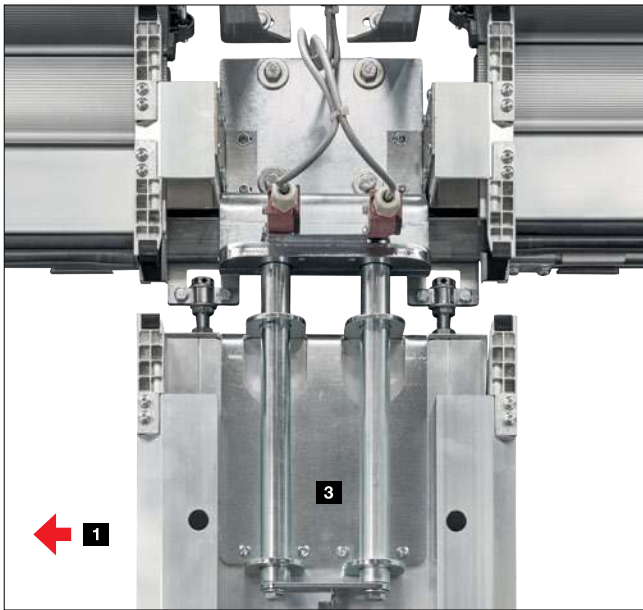

Details

- Can be quickly and easily moved sideways thanks to a low-friction track behind the lintel **1**
- No components swivelling inwards or outwards
- Narrow centre support made of aluminium with a width of only 375 mm
- Espagnolette lock **2** with function monitoring prevents door travel when the centre support is unlocked
- Robust bolts at the lintel and floor for secure locking and a reliable transmission of wind loads. **3**

Exterior view

- Mill-finished aluminium as standard with line design **4**

Rolling shutter DD S6

Optimises the flow of traffic and reduces energy loss



Soft start
Soft stop

Quick door opening

With the optional accessory package S6, the rolling shutter DD with Decotherm curtain opens at up to 1.1 m/s – almost as fast as a high-speed door.

Economical door system

This door / operator solution is characterised by significantly smaller fitting dimensions as well as lower purchasing and operating costs compared to a high-speed door. For a longer overall service life, the door construction is designed for 200000 door cycles* (OPEN / CLOSE).

Secure monitoring

The operator with soft start and soft stop function ensures gentle door travel. The standard safety light curtain monitors the closing zone of the door up to a height of 2500 mm and stops the door without contact if people or objects are in the opening.

Maximum / door sizes

- Rolling shutter
width up to 7500 mm
height up to 8500 mm

* With regular maintenance including replacement of wearing parts



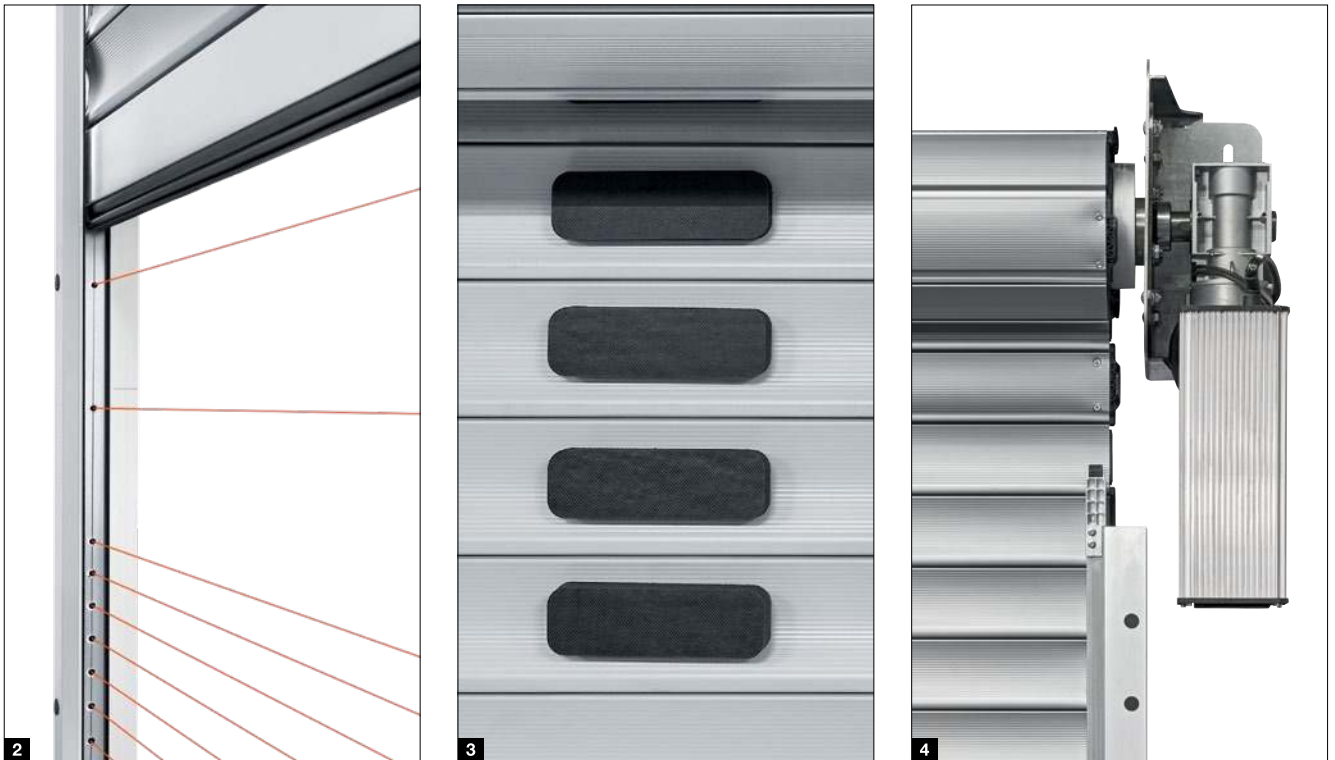

Optional accessory package S6

- For rolling shutter DD with Decotherm S curtain
- Powerful 1-phase FU operator (220 – 230 V, 50 / 60 Hz) with soft start and soft stop for gentle door travel **1**
- Up to 30 door cycles per hour or 300 per day
- Light grilles in the side guides safeguard the door area even with high closing speeds **2**
- L-Pads on the inside of the curtain to minimise noise and wear **3**
- Space-saving design with only 100 mm of additional required headroom compared to a standard version rolling shutter DD **4**
- Optionally with window profiles

Curtain variants

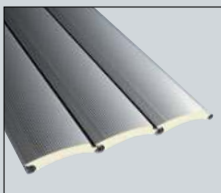

Decotherm S, steel
Max. door width: 7500 mm
Door height 2500 – 8500 mm



Plastic wind lock
as standard

For further information on the curtains,
see pages 52 – 53.

Rolling shutter laths and rolling grille curtains

Rolling shutter lath Decotherm S, steel

The double-skinned lath made of galvanized steel with a PU infill offers high resistance. The geometry optimised for winding with curved outer and inner surfaces ensures good winding behaviour. Lined profile view on interior and exterior, optionally with high-quality colour coating in RAL to choose.

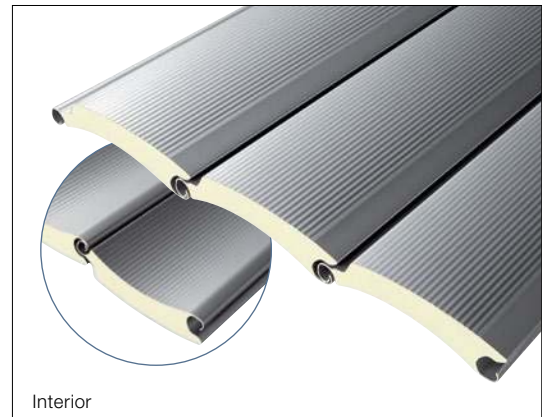

Rolling grille curtain HL-L, aluminium

The elegant and lightweight aluminium version is particularly suitable for use in collective garages and shopping arcades. The grilles with honeycomb connections with aluminium crossbars provide protection to exclude the possibility of reaching through.



Rolling grille curtain HG-V, aluminium (reinforced)

The aluminium curtain reinforced with V2 A stainless steel honeycomb connections is ideal for wide openings in underground garages or multi-storey car parks where there is frequent door travel.



Rolling grille curtain HG-S, steel

The galvanized steel version is particularly robust. The curtain is also available with high-quality colour coating to choose.



Individual colour schemes

High-quality colour coating for a long-lasting and beautiful door appearance

Standard colours

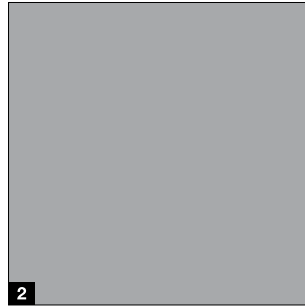
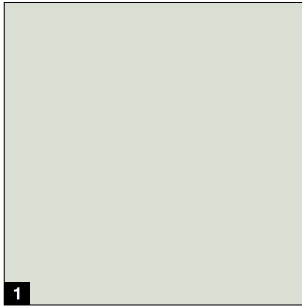

Standard colours

- 1 RAL 9002 Grey white
- 2 RAL 9006 White aluminium

Preferred colours

- 3 RAL 9016 Traffic white
- 4 RAL 9007 Grey aluminium
- 5 RAL 9005 Jet black
- 6 RAL 8028 Terra brown
- 7 RAL 7016 Anthracite grey
- 8 RAL 6005 Moss green
- 9 RAL 5010 Gentian blue
- 10 RAL 3000 Flame red

Preferred colours

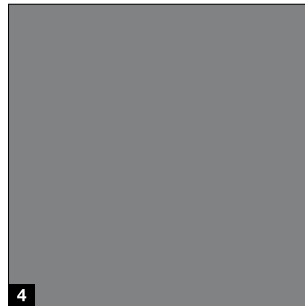
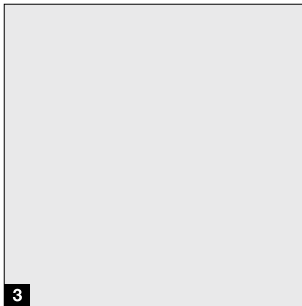

Special colours
in RAL to choose

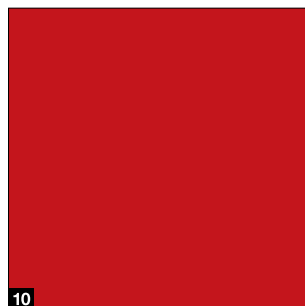
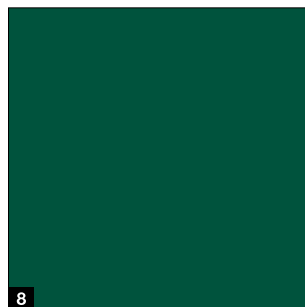
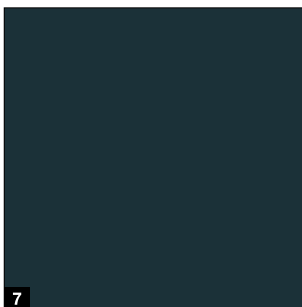
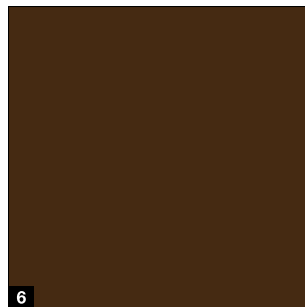
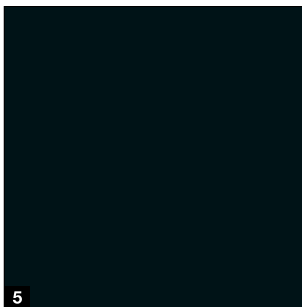

High-quality coating

Coil-coated rolling shutter laths provide long-term protection against adverse weather effects for surface finishes. Additional protective paint with polyamide particles reduces abrasion and noise. All curtain and door types feature a bright-rolled bottom profile.

Note

The colours shown are subject to the limitations of the printing process and cannot be regarded as binding. All colours are based on the RAL colour chart. Slight colour variations are permissible.

Break-in resistance equipment

For secure night locking

Lockable bottom profile with profile cylinder for all door types

Actuation can be selected either from the exterior **1** or interior or only from the interior **2**.

Shootbolt

for rolling shutter / rolling grille SB

The shootbolts **3** are fitted on the interior on the right and left end of the bottom profile (not suitable for external rolling shutters).

Shootbolt

for rolling shutter / rolling grille DD

The shootbolt **4** can be fitted either on the left, right or both sides. Locking is secured with a padlock (not suitable for external rolling shutters).

Automatic locking ETV-1 **5**

A bolt automatically locks the door* when the "CLOSE" end-of-travel position is reached. When locked, the bolt is mechanically blocked and thus protected against possible manipulation by pushing the bolt in by hand. Manual emergency release is still possible at any time.

The locking ETV-1 is available for the controls 445 R, 460 R and for third-party controls.

* With ETV-1, additional limit switch reporting is required

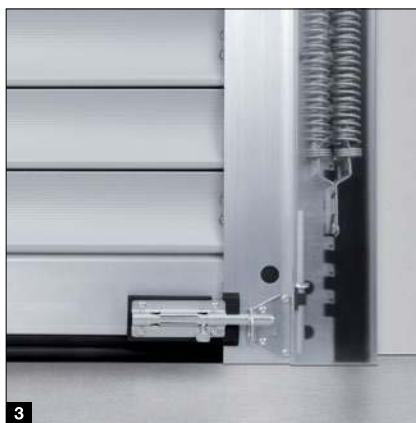

Glazing beads and ventilation laths, panels

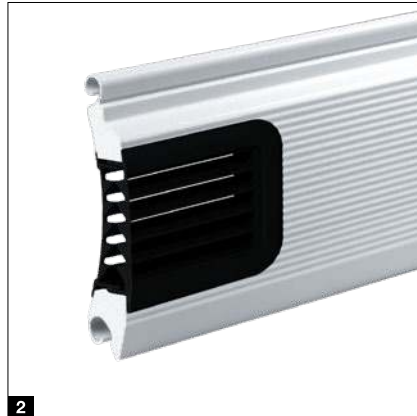

Window profiles and ventilation laths

For more light and better ventilation

1 Windows

Synthetic double pane, clear
Dimensions: 150 × 55 mm

2 Ventilation grille

Ventilation cross section
per grille: 27 cm²
Dimensions: 150 × 55 mm



3 Ventilation opening

Ventilation cross-section
per opening: 57 cm²
Dimensions: 150 × 55 mm

Window profiles and ventilation laths
reduce the resistance to wind load.



NEW. Fascia panel BST60 and side panel BSL60

The panels are manufactured
with high-quality frame profiles made
of anodised aluminium E6 / C-0.
The panel infills are available
to match the curtains to the door
system to ensure a harmonious
appearance.



Side doors

Matching the door

Side door NT 60 R

- For all rolling shutter and rolling grille curtains
- 60 mm anodised (E6 / C-0) aluminium frame construction
- As standard with all-round seals made of long-lasting, weather-resistant EPDM
- Two-part hinges, three-way adjustable
- Curtains fixed by glazing beads
- Optional fascia panel BST60 and side panel BSL60 with matching frame profiles and curtains (shown on page 53)

Version with rolling shutter curtains

- 1 Exterior view
- 2 Viewed from inside with 3-way adjustable hinge
- 3 Interior view with synthetic glazing
- 4 Lever handle set as standard

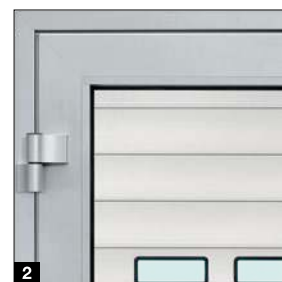

Version with rolling grille curtains

- 5 Exterior view
- 6 Viewed from inside with 3-way adjustable hinge
- 7 Lever handle set as standard
- 8 Optional synthetic pane to provide protection to exclude the possibility of reaching through

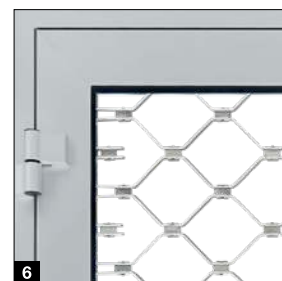
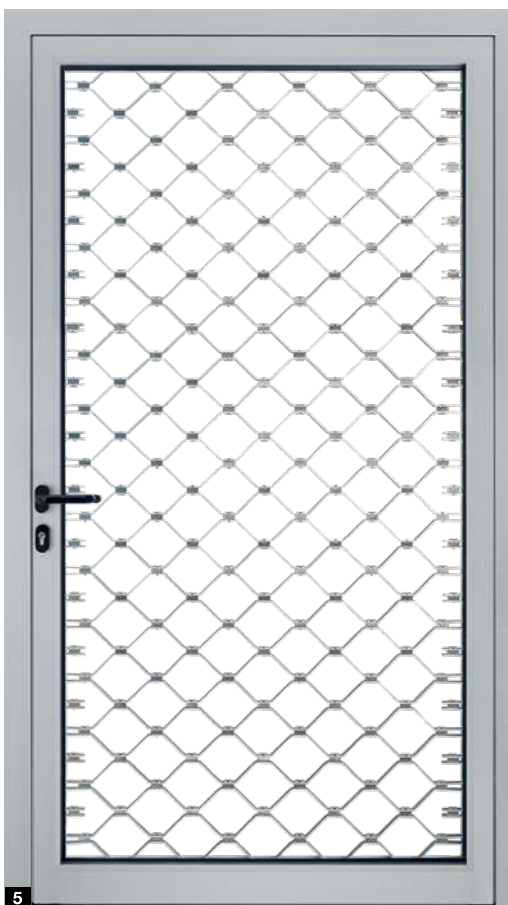

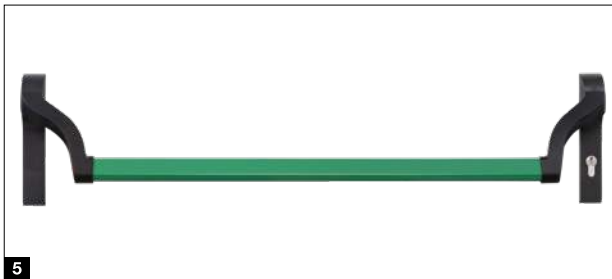
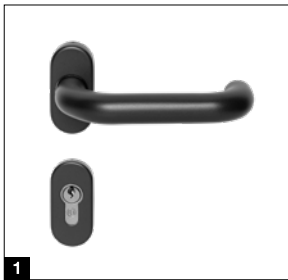

Fittings

- Mortice lock with profile cylinder
- Offset lever handle set, with oval rose escutcheons made of black plastic **1**
- On request also available as lever / knob handle sets
- Optionally available in natural finish cast aluminium **3**, polished stainless steel **3** or brushed stainless steel **4**

Optional equipment

- Stainless steel push bar 38-2, brushed, 1000 mm high, exterior, additionally with stainless steel lever handle set, interior
- Push bar **5** in black / green or stainless steel, for escape door, interior (anti-panic lock required)
- Multiple-point locking also with anti-panic functions B, D, E
- Overhead door closer with hold-open device



Multi-purpose door MZ Thermo65

Steel side doors with thermal break

- 65 mm thick door leaf with thermal break and PU rigid foam infill
- Aluminium block frame with thermal break and threshold with thermal break
- High thermal insulation with a U-value = 0.82 W/(m²·K)
- Optionally available with RC2 security features as KSI Thermo46 with 46 mm thick door leaf



For further information on the multi-purpose door MZ Thermo65, see the brochure.

Controls

Compatible system solutions



	Internal control WA 250 R S4	Internal control WA 300 R S4	External control 300	External control 360	Impulse sequence control 445 R
Door type / operators					
Rolling shutter / rolling grille SB with WA 250 R S4	●	-	-	-	-
Rolling shutter / rolling grille SB / TGT with WA 300 R S4	-	●	-	○	-
Rolling shutter / rolling grille SB / TGT with WA 300 AR S4	-	-	●	○	-
Rolling shutter / rolling grille DD with direct drive operator	-	-	-	-	●
Rolling shutter DD with accessory package S6	-	-	-	-	-
Functions / features					
Control and operator can be fitted separately	-	-	●	●	●
Adjustment work can be conveniently done directly on the control	-	-	●	●	●
Soft start and soft stop	●	●	●	●	-
Power limit in OPEN / CLOSE directions ⁴⁾	-	●	●	●	-
Second opening height with additional button	-	○ ²⁾	○ ²⁾	●	-
Status and error display via LED	●	●	●	-	-
7-segment display with menu reading from outside (maintenance, cycle and operating hours counter as well as fault analysis)	-	-	-	●	●
Collective malfunction signalling with on-site individual display: acoustic, visual, or e.g. via mobile phone	-	-	-	○	○
Extension possible with external radio receiver	-	●	●	●	●
Automatic timer ¹⁾	-	●	●	●	-
Traffic control ¹⁾	-	-	-	○	-
Connecting terminals for additional command units	-	●	●	●	●
Function lock via miniature lock	○	○	●	● ⁵⁾	● ⁵⁾
Without safety edge SKS: OPEN / CLOSE in press-and-release operation ⁴⁾	-	●	●	●	-
Standard accessory DTH-R push button	●	●	-	-	-
Power supply	230 V	230 V	230 V	230 V	400 / 230 V
Main switch integrated into control housing	○ ³⁾	○ ³⁾	○	○	○
Protection class IP 65 (jet-water protected) for control and door leaf components	●	●	●	●	●

● = As standard
 ○ = With corresponding equipment with additional control, if applicable
 - = Not available

¹⁾ Only in combination with an activating kit for warning lights and photocell or light grille

²⁾ Possible in combination with UAP1-300 and DTH I or DTH IM

³⁾ In combination with push button control 300 U

⁴⁾ In the CLOSE direction, the power limit is only possible in the indicated curtain variants and size ranges (see "Impulse operation without safety edge", see page 37)

⁵⁾ Convertible to profile half cylinder



**Comfort control
460 R**

**Frequency
converter
control B 971 R
S6**

-	-
-	-
-	-
○	-
-	●
●	●
●	●
-	●
-	-
●	-
-	-
●	●
○	○
●	●
●	●
○	-
●	●
● 5)	● 5)
-	-
-	-
400 / 230 V	230 V
○	○
●	●



**Optional:
Profile half cylinder**
For all external controls
(except control 300)



**Optional:
Main switch**
For all external controls



Combination control 420 Si / 420 Ti
Combination of the door operation with the operator WA 300 R S4 / WA 300 AR S4 and a standard dock leveller control;
Advantages:
• Easy to fit
• Inexpensive
• Compact
• Suitable for hinged lip (420 Si) and telescopic lip dock leveller (420 Ti)
• Optional: Integration of the OPEN limit switch reporting for dock leveller release



**Optional:
Post STI 1**
For fitting a maximum
of 2 controls with
additional housing,
colour: White
aluminium, RAL 9006,
Dimensions:
200 × 1660 × 60 mm
(W × H × D)



**Optional:
Radio transmission unit**
For transmission of signals from the door curtain to the control via
Bluetooth – instead of a coiled cable. Power supply via a high-performance
battery. For controls: 445 R / 460 R

Controls

Air inlet control AC72

For smoke extraction concepts with industrial doors

Smoke and heat extraction systems are an essential part of preventive fire protection and personal safety. In the event of fire, windows and transom lights in the facade and ceiling area are opened, allowing smoke and fumes to be discharged from the building. At the same time, fresh air is supplied from below via building openings such as inlet flaps in the building facade.

Thanks to the air inlet control AC72, door systems can also be integrated into smoke extraction concepts to securely supply fresh air. When the fire alarm system is triggered, the AC72 automatically transmits the impulse for door opening to the minimum required opening height within 60 seconds. Additionally, the AC72 complies with the general requirements for smoke extraction systems, such as monitored battery operation in case of power failure for 72 hours. By integrating industrial doors into the smoke extraction concept of your building, you can reduce investment and fitting costs of additional ventilation flaps and improve the thermal insulation of the building, as fewer doors have to be integrated into the facade.

- Fulfils the requirements of FVLR Directive 13 (trade association for daylight and smoke ventilation):
Downstream openings for smoke and heat exhaust ventilation systems
- Conforms to product standard for doors DIN EN 13241

Inlet air control based on

DIN EN 12101-2 / 3 and DIN 18 232-9 (8)

- Automatic opening within 60 seconds
- Monitored battery operation in case of power failure for 72 hours
- Monitoring of the line from the RWA to the AC72

Protection goals for supporting self-rescue and third-party rescue

- Support of firefighting operations
- Prevention of uncontrolled smoke propagation
- Delay or prevention of a flash-over
- Property protection
- Containment of environmental damage

RWA smoke and heat extraction

- Smoke extraction in the event of fire thanks to a robust, low-smoke layer near the floor (by using targeted air supply)
- To ensure escape and rescue routes



Industrial buildings

Operator / control combinations with the AC72:

- Operator WA 300 R S4 with control 300 U
- Operator WA 300 AR S4 with control 300 U



Logistics buildings

Operator / control combinations with the AC72:

- Operator WA 300 R S4 with control 420 Si / 420 Ti for dock levellers



Accessories

Hand transmitter, radio switch, receiver



HS 5 BS
4 button functions plus query button, high-gloss surface black or white



HS 5 BS
4 button functions plus query button, textured surface matt black



HS 4 BS
4 button functions, textured surface matt black



HS 1 BS
1 button function, textured surface matt black



HSE 1 BS
1 button function, including eyelet for key ring, textured surface matt black



HSE 4 BS
4 button functions, incl. eyelet for key ring, textured surface matt black with chrome or plastic caps



4-button security hand transmitter HSS 4 BS
Additional function: copy protection for hand transmitter coding, with chrome caps



Only from Hörmann

Modern radio system

The bi-directional BiSecur radio system is based on future-oriented technology for the convenient and secure operation of industrial doors. The extremely secure BiSecur encryption protocol makes sure that no one can copy your radio signal. It was tested and certified by security experts at Bochum university.

Your advantages

- 128-bit encryption with the same high security level as online banking
- Interference-resistant radio signal with a stable range
- Convenient querying of the door position*
- Backwards compatible, i.e. radio receivers with the frequency 868 MHz (2005 to June 2012) can also be operated with BiSecur control elements

* For WA 300 S4 with optional bi-directional receiver ESEi BS, for all other operators with optional bi-directional receiver HET-E2 24 BS and end-of-travel position feedback



**Radio code switch
FCT 3 BS**

3 functions, with illuminated buttons, recessed or surface-mounted fitting possible, plastic housing in Light grey RAL 7040 (also available with 10 functions and hinged cover, painted in White aluminium RAL 9006)



**Radio code switch
FCT 10 BS**

10 functions, with illuminated buttons and hinged cover, recessed or surface-mounted fitting possible, plastic housing painted in White aluminium RAL 9006



**Radio finger-scan
FFL 25 BS**

2 functions and up to 25 finger-prints, with hinged cover, recessed and surface-mounted fitting possible, plastic housing painted in White aluminium RAL 9006



**Radio radar button
FSR 1 BS**

Sensor for non-contact opening, plastic housing, IP 41
For recessed and surface-mounted fitting

Radar button HTR 1-230 / 1-24
Wired version with 230 V or 24 V



**Industrial hand transmitter
HSI 3 BS, HSI 6 BS, HSI 15 BS**

For controlling up to 3 doors (HSI 3 BS), 6 doors (HSI 6 BS) or 15 doors (HSI 15 BS), with extra-large buttons for easier operation with work gloves, impact-resistant housing protection category: IP 65



**Industrial hand transmitter
HSI BS**

To control up to 1000 doors, with a display and extra-large quick selection buttons for easier operation with work gloves, transferring of hand transmitter coding to other devices possible



**3-channel receiver
HEI 3 BS**

For controlling 3 functions

**Bi-directional receiver
ESEi BS**

For querying the door position



**1-channel relay receiver
HER 1 BS**

1 volt-free relay output with status query



**2-channel relay receiver
HER 2 BS**

2 volt-free relay outputs with status query and external antenna



**2-channel relay receiver
HET-E2 24 BS**

2 volt-free relay outputs for choosing the direction, one 2-pin input for volt-free Open and Close limit switch reporting (for querying the door position)



**4-channel relay receiver
HER 4 BS**

4 volt-free relay outputs with status query

Accessories

Button



Push button DTH-R / DTH-RM
Separate control of both operational directions; separate stop button, with miniature lock (DTH-RM only): Control of the operator is deactivated – operator movement is no longer possible (2 keys included in the scope of delivery)

Dimensions:
90 × 160 × 55 mm (W × H × D)
protection category: IP 65



Push button DTH-I / DTH-IM
To move the door into the OPEN / CLOSE positions, separate stop button to stop door travel, ½ Open button to open the door up to the programmed intermediate travel limit, with miniature lock (DTH-IM only): operator control is deactivated, operator movement is no longer possible (2 keys included in the scope of delivery)

Dimensions:
90 × 160 × 55 mm (W × H × D)
protection category: IP 65

Note:
With integrated control WA 300 S4, only in combination with UAP 1-300, not for control 445 / 545



Push button DTP 02
Opening or closing via a command button, separate stop button, operation control light for control voltage, lockable with profile half cylinder (available as an accessory)

Dimensions:
77 × 235 × 70 mm (W × H × D),
protection category: IP 44

Note:
The lockable function serves to isolate the control voltage and immobilises the command units. Profile half cylinders are not included in the scope of delivery for the push buttons.



Push button DTP 03
For separate control of both operational directions, separate stop button, operation control light for control voltage, lockable with profile half cylinder (available as an accessory)

Dimensions:
77 × 270 × 70 mm (W × H × D),
protection category: IP 44



Key switch ESU 30
With 3 keys, recessed version, impulse or OPEN / CLOSE functions selectable; dimensions of switch box: 60 mm (d), 58 mm (D), dimensions of the panel: 90 × 100 mm (W × H), brickwork recess: 65 mm (d), 60 mm (D), protection category: IP 54

Surface-mounted version ESA 30
(not shown)
Dimensions:
73 × 73 × 50 mm (W × H × D)



Key switch STAP 50
With 3 keys, surface-mounted version
Dimensions:
80 × 80 × 63 mm (W × H × D);
protection category: IP 54

Key switch STUP 50 with 3 keys,
recessed version (not shown)
Dimensions:
80 × 80 mm (W × H);
protection category: IP 54



Pull switch ZT 2 with cord
Impulse transmission to open or close the door
Dimensions:
60 × 90 × 55 mm (W × H × D);
length of pull cord: 3.2 m;
protection category: IP 65

Cantilever arm KA1 (not shown)
Extension 1680 – 3080 mm,
can be used with ZT 2



Posts
With a screw base for fitting to the floor, surface finish in White aluminium RAL 9006, 90 × 90 mm tube, also available as a set-in-concrete version

Post STN 1
To hold 1 command unit on the surface, height 1050 mm

Post STN 1-1
To hold 2 command units or 1 command unit and 1 warning light, height 1200 mm

For command units:
CTR 1b-1, CTR 3b-1, CTV 3-1,
CTP 3-1, TTR 1000-1, FL 150,
STUP 50, LED double warning lights red / green



Code switch CTR 1b-1, CTR 3b-1
 For 1 (CTR 1b-1) or 3 (CTR 3b-1) functions, with illuminated buttons
 Dimensions:
 80 × 80 × 15 mm (W × H × D)



Code switch CTV 3-1
 For 3 functions, with particularly robust metal keypad
 Dimensions:
 80 × 80 × 15 mm (W × H × D)



Code switch CTP 3
 For 3 functions, with illuminated lettering and touch-sensitive surface
 Dimensions:
 80 × 80 × 15 mm (W × H × D)



Decoder housing
 For code switches CTR 1b-1, CTR 3b-1, CTV 3-1, CTP 3
 Dimensions:
 140 × 130 × 50 mm (W × H × D),
 Switching capacity:
 2.5 A / 30 V DC
 500 W / 250 V AC



Finger-scan FL 150
 For 2 functions, up to 150 fingerprints can be saved
 Dimensions:
 80 × 80 × 13 mm (W × H × D);
 decoder housing:
 70 × 275 × 50 mm (W × H × D);
 switching capacity:
 2.0 A / 30 V DC



Radar movement detector RBM 2
 For OPEN impulse with directional recognition, max. fitting height: 6 m; optional remote control for radar movement detector
 Dimensions:
 155 × 132 × 58 mm (W × H × D);
 contact load: 24 AC / DC, 1 A (resistive load);
 protection category: IP 65



Transponder key switch TTR 1000-1
 For 1 function via transponder key or transponder card; up to 1000 keys or cards can be saved
 Dimensions: 80 × 80 × 15 mm (W × H × D);
 decoder housing: 140 × 130 × 50 mm (W × H × D);
 switching capacity: 2.5 A / 30 V DC; 500 W / 250 V AC

Accessories

Button, detector, receiver



Bluetooth receiver HET-BLE

For operation, impulse sequence control of industrial rolling shutters via the Hörmann BlueSecur app

Dimensions:

110 × 45 × 40 mm (W × H × D)



UAP 1-300

For WA 300 R S4 or control 300; impulse selection, partial opening function, limit switch reporting and activating kit for warning light with 2 m system cable,

Dimensions:

150 × 70 × 52 mm (W × H × D);
max. switching capacity:
0 V DC / 2.5 A (resistive load),
250 V AC / 500 W (resistive load);
protection category: IP 65



HOR 1-300

For WA 300 R S4 or control 300 to control limit switch reporting or warning lights with 2 m connecting lead; optionally available for fitting in push button control 300 U (not shown)

Dimensions:

110 × 45 × 40 mm (W × H × D);
max switching capacity:
30 V DC / 2.5 A (resistive load),
250 V AC / 500 W (resistive load);
protection category: IP 44



Reflection photocell RL 50 / RL 300

Photocell with transmitter / receiver module and reflector
 The photocell is tested by the control prior to each closing cycle.
 Connected via a system cable (RL 50, length 2 m) or a 2-wire cable
 (RL 300, length 10 m)

Dimensions: 45 x 86 x 39 mm (W x H x D),
 protection category: IP 65

Reflector range up to 8 m (standard): 30 x 60 mm (W x H),
 reflector range up to 12 m (not shown): 80 mm diameter,
 optional: weather protective cover (shown on right), anti-fog coating



One-way photocell EL 51

Photocell with separate transmitter and receiver
 The photocell is tested by the control prior to each closing cycle.
 Connected via a system cable
 Max. range 8.0 m

Dimensions with fitting bracket:
 45 x 85 x 31 mm (W x H x D),
 protection category: IP 65,
 optional: weather protective cover (shown on right)

Light grille HLG-V as advance protection

The light grille additionally monitors the main closing edge of the door up to a height of 2500 mm. Fitting is possible both on the outside of the facade and in the reveal as well as to the side guide. The HLG-V can also be optionally integrated in key switch post set STL consisting of weather-resistant anodised aluminium.

Range: max. 10 m,
 protection category: IP 65,
 operating temperature: -20°C to +60°C,
 resolution: < 50 mm (below 500 mm);
 < 200 mm (above 500 mm),
 increased safety due to angled beams
 technology, simple alignment possible,
 connecting leads included in the scope
 of delivery

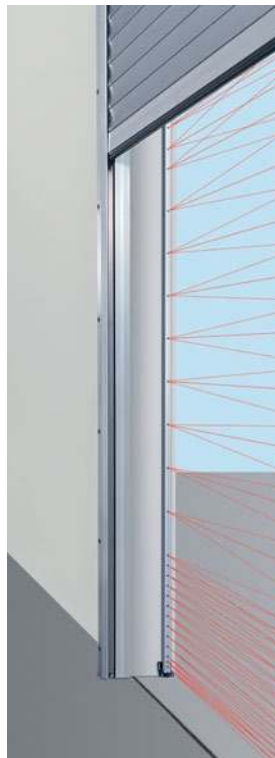

Fitting in the reveal

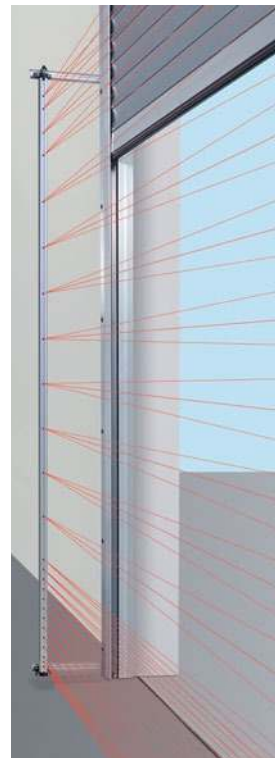

Fitting to the side guide

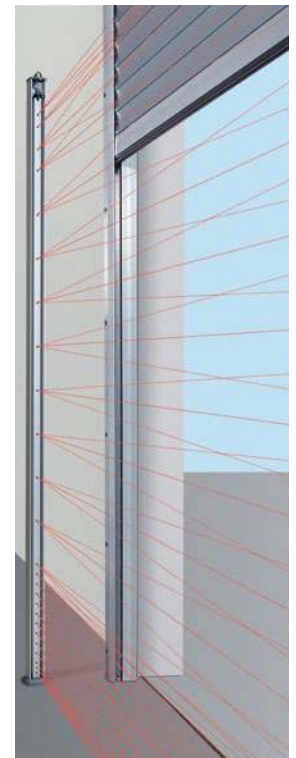

Fitting with the key switch
 post set STL

Accessories

Activating kits, LED traffic lights



Multi-function circuit board to be fitted in an existing housing or optionally in a separate extension housing (shown)

Limit switch reporting, momentary impulse, collective malfunction signalling, extension unit for controls 360, 445 R, 460 R

Dimensions of additional housing: 202 × 164 × 130 mm (W × H × D); protection category: IP 65

A circuit board can be optionally mounted in the control.



Digital weekly timer in a separate additional housing

The timer can switch command units on and off via a volt-free contact; extension unit for controls 360, 445 R, 460 R (for fitting in existing housing); switching capacity: 230 V AC 2.5 A / 500 W, can be switched over to summer / winter time, manual switching: automatic operation, switching pre-selection permanently ON / OFF

Dimensions of additional housing: 202 × 164 × 130 mm (W × H × D); protection category: IP 65



Summer / winter activating kit in additional housing

Function for full door opening and individually programmable intermediate travel limit; extension unit for controls 360, 445 R, 460 R

Dimensions of additional housing: 202 × 164 × 130 mm (W × H × D); protection category: IP 65



DI 1 induction loop in a separate additional housing

Suitable for one induction loop, detector with a normally open contact and a change-over contact



DI 2 induction loop (not shown) in a separate additional housing, Suitable for two separate induction loops; detector with two volt-free normally open contacts; can be set for impulse or permanent contact; directional recognition possible

Dimensions of additional housing: 202 × 164 × 130 mm (W × H × D); switching capacity: DI 1: low voltage 2 A, 125 V A / 60 W; DI 2: 250 V AC, 4 A, 1000 VA (resistive load AC); supplied: without loop cable

Loop cable for induction loop: 50 m roll, cable designation: SIAF, cross-section: 1.5 mm², colour: brown



Activating kit for warning lights for fitting in an existing housing or optionally in a separate extension housing (shown)

incl. 2 LED traffic lights TL40S ye;
extension unit for control 360, 445 R, 460 R,
with activating kit for warning lights as a visual indicator during door travel
(weekly timer, optionally for 360, 445 R, 460 R), applications: approach
warning (for 360, 445 R, 460 R), automatic timer (for 360, 460 R)

After the set hold-open phase has elapsed (0 – 480 s),
the warning lights flash during the set pre-warning time (0 – 70 s).

Dimensions of additional housing: 202 × 164 × 130 mm (W × H × D),
contact load: 250 V AC; 2.5 A / 500 W;
protection category: IP 65



Traffic control in a separate additional housing (460 R) or for fitting in an existing housing (360)

incl. 2 LED traffic lights TL40S rd / gn
or 2 LED traffic lights TL40S rd / ye* / gn;
extension unit for control 360, 460 R, with activating kit for warning
lights as a visual indicator for regulating the entrance and exit
(optional weekly timer),
Green phase time: adjustable 0 – 480 s,
clearance phase time: adjustable 0 – 70 s

Dimensions of additional housing: 202 × 164 × 130 mm (W × H × D),
contact load: 250 V AC; 2.5 A / 500 W;
protection category: IP 65

* Yellow is not required for traffic control



LED traffic light TL40S rd

1-light, red,
supply voltage
100 – 240 V AC /
50 – 60 Hz
Nominal power approx. 2 W
Protection category: IP 65

Dimensions:
180 × 250 × 290 mm
(W × H × D)

LED traffic light TL40S ye

1-light, yellow,
supply voltage
100 – 240 V AC /
50 – 60 Hz
Nominal power approx. 2 W
Protection category: IP 65

Dimensions:
180 × 250 × 290 mm
(W × H × D)

LED traffic light TL40S gn

1-light, green,
supply voltage
100 – 240 V AC /
50 – 60 Hz
Nominal power approx. 2 W
Protection category: IP 65

Dimensions:
180 × 250 × 290 mm
(W × H × D)

LED traffic light TL40S rd / gn

2-light, red / green,
supply voltage
100 – 240 V AC /
50 – 60 Hz
Nominal power approx. 2 W
Protection category: IP 65

Dimensions:
180 × 467 × 290 mm
(W × H × D)

LED traffic light TL40S rd / ye / gn

1-light, red / yellow / green,
supply voltage 24 V DC
Nominal power approx. 2 W
Protection category: IP 65

Dimensions:
180 × 250 × 290 mm
(W × H × D)

Performance characteristics

acc. to EN 13241

Door type		Rolling shutter SB	Rolling grille SB
Profile type		Decotherm S PUR-foamed	HG-L
Wind load EN 12424	Class 4 Wind lock	● ●	- ●
Water tightness EN 12425		0	0
Thermal insulation	Appendix B EN 12428 Individual door section (U = W/(m ² ·K))	3,9	-
	Shutter 4 × 4 m, fitted (U = W/(m ² ·K))	4,1	-
Acoustic rating	Shutter 3.5 × 2 m, fitted (R _w = dB)	18	-
Door sizes	Max. width (mm)	5000	6000
	Max. height (mm)	4500	4500
Door curtain surface finish	Galvanized steel	●	-
	Galvanized steel with coating in standard colours	○	-
	Galvanized steel with coating in preferred colours	○	-
	Galvanized steel with coating in RAL to choose	○	-
	Aluminium	-	●
	Aluminium with coating in standard colours	-	○
	Aluminium with coating in preferred colours	-	○
	Aluminium with coating in RAL to choose	-	○
Own weight of door curtain	Anodised aluminium E6 / C-0	-	○
Own weight of door curtain	kg/m ² approx.	10,3	6,5
Side door	Matching the door	○	○
Glazing	Standard arrangement	○	-
	Logistics arrangement	○	-
Break-in resistance equipment	Pull-out protection	●	●
	Inside locking	○	○
	Inside and outside locking	○	○
Security features	Trap guard / curtain cover	○	○
	Safety catch	●	●
Fastening options ²⁾	Concrete	●	●
	Steel	●	●
	Brickwork	●	●
	Timber	●	●

● = As standard
○ = Optional

¹⁾ Shutter 4000 × 2400 mm, fitted

²⁾ For performance package W4, there are partial restrictions on the fastening options on the building structure

Rolling shutter TGT	Rolling grille TGT	Rolling shutter DD	Rolling grille DD		
Decotherm S PUR-foamed	HG-L	Decotherm S PUR-foamed	HG-L	HG-V	HG-S
●	-	○	-	-	-
●	●	●	●	●	●
0	0	0	0	0	0
3,9	-	3,9	-	-	-
4.2 ¹⁾	-	4,1	-	-	-
18	-	18	-	-	-
5000 2400	6000 2400	12000 9000	9000 5500	12000 8000	12000 8000
●	-	●	-	-	●
○	-	○	-	-	-
○	-	○	-	-	-
○	-	○	-	-	○
-	●	-	●	●	-
-	○	-	-	-	-
-	○	-	-	-	-
-	○	-	○	-	-
-	○	-	○	-	-
10,3	6,5	10,3	6,5	7,5	15
○	○	○	○	○	○
○	-	○	-	-	-
○	-	○	-	-	-
●	●	●	●	●	●
○	○	○	○	○	○
○	○	○	○	○	○
●	●	○	○	○	○
●	●	●	●	●	●
●	●	●	●	●	●
●	●	●	●	●	●
●	●	●	●	●	●
●	●	●	●	●	●

Everything from a single source for construction and industry

Our large product range offers the right solution for any requirement. All products are optimally adjusted to work together, ensuring high functional safety. This makes us a strong, future-oriented partner for industrial and public construction projects.

**INDUSTRIAL DOORS. LOADING TECHNOLOGY. SLIDING DOORS.
CONSTRUCTION PROJECT DOORS. PERIMETER PROTECTION SYSTEMS.**



Some of the products shown feature special equipment and do not always correspond to the standard versions. The surface finishes and colours shown are subject to the limitations of the printing process and cannot be regarded as binding. All RAL colours are based on the RAL colour chart. All rights reserved. No part may be reproduced without our prior permission. Subject to changes.