



RESIDENTIAL INTERNAL DOORS

NEW. More design options with the DesignLine Slat, Line, Brisk, and Palladio door series, complemented by high-quality lever handle sets in black, stainless steel and brass

HÖRMANN



04



14



58



Content

04 Good reasons to try Hörmann

14 Inspirations

16 ProLine

27 DesignLine

38 ClassicLine

42 GlassLine

44 Steel loft doors

46 Sliding doors

50 Reverse timber door

51 Zeroline frame

52 Function and construction project doors

56 Accessories

58 Design, equipment, accessories

60 Door styles

78 Surface finishes

84 Lever handle sets and door fittings

88 Door fittings black.edition

91 Brass door fittings

92 Lever handle sets and door fittings for glass doors

94 Door fittings and handles for sliding doors

96 Glazing cut-outs, side elements, transom lights

98 Door and frame design

100 Door and frame types

103 VarioFix steel frame

104 Zeroline frame

105 Reverse timber door

106 Function and construction project doors

108 Dimensions and technical manual

Responsibility for generations

The Hörmann family business has over 85 years of experience as a construction component specialist. This gives us an obligation to both current and future generations. That's why environmental responsibility plays such an important role for us. With this in mind, we develop innovative solutions for sustainable products and intelligent environmental protection.



“A GOOD REPUTATION MUST BE EARNED.”

August Hörmann

In keeping with the tradition started by the company's founder, the Hörmann brand is a true promise of quality and, with sales of over 20 million doors, door frames and operators, is one of Europe's most successful suppliers. Due to the comprehensive international sales and service network, Hörmann is your strong partner for high-quality construction components.



WE THINK AND ACT GREEN. As a family business, we are very conscious of our responsibility to future generations and offer all products for residential construction CO₂-neutral as standard. The Hörmann sustainability strategy aims to reduce and avoid emissions. We cover 100% of our electrical power needs at all European production sites with genuine green electricity from renewable sources. We also apply many other measures to reduce our consumption and save more than 75000 tonnes of CO₂ each year. We work with ClimatePartner to offset the remaining emissions by supporting certified climate protection projects.



You can find further information at
www.hoermann.com/sustainability



ClimatePartner
certified product
climate-id.com/XNEBKC



CO₂
measure
reduce
contribute

Brand quality made in Germany





The family-owned company Hörmann offers all important construction components for building and renovating projects from a single source. We manufacture in highly specialised factories using state-of-the-art production technologies. Our employees work intensively on new products, continual further developments and improvements to details. The results are patents and unique products on the market.



LONG-LASTING. GUARANTEED. All doors are developed and manufactured by Hörmann. Endurance tests under real conditions ensure mature series products with Hörmann quality. For this reason and thanks to quality assurance without compromise, you can enjoy a Hörmann residential internal door for years to come. You are literally choosing a door for life.

CONVINCING PREMIUM WORKMANSHIP. For the door and frame construction, we rely exclusively on high-quality timber materials. Screw connections guarantee an excellent fit and seamless frame appearance. Frame reinforcements in the door leaf and sturdy door fittings ensure high stability and resistance. The modern, in-house production technology for the Duradecor surface finish impresses with consistently high quality and an impact resistance that is on average 48% better* than that of tested CPL surfaces of other manufacturers.

 SUCCESS BY QUALITY! <small>Erstklassige- und Prüfzettel-Produktionsgesellschaft Zähringer Weg 24 · 40237 Simmeron · Germany www.eph-berlin.de Akkreditierter Prüflabor der Staatlichen Prüfstelle für Bauteilprüfung Bewertung DIN CERTCO</small>		 <small>Deutscher Akkreditationsrat DAkkS D-10245 Berlin 030 25064-0</small>	
		<small>akkreditiert durch die Deutsche Akkreditierungsstelle GmbH (DAkkG) von DIN CERTCO anerkanntes Prüflabor für Bauteilprüfung</small>	
KURZBERICHT			
Auftrags-Nr.: 2713082-2013			
Seite 1 von 3			
Auftraggeber (AG):	Hörmann KG Verkaufsgesellschaft Upheider Weg 94 - 98 33803 Steinhagen		
Auftrag vom:	11.03.2013		
Prüfgegenstand:	6 Türblätter mit CPL-Beschichtung (Variante 1 + 6) verschiedener Hersteller 3 Türblätter mit Duradecor-Beschichtung (Variante 7 - 9) von Hörmann		
Probennahme:	Anlieferung durch AG am 14.03.2013		
Prüfauftrag:	Durchführung ausgewählter Prüfungen an Türblattoberflächen		
Prüfgrundlagen:	<ol style="list-style-type: none"> 1. Bestimmung der Fleckenunempfindlichkeit nach EN 12720/ DIN CEN/TS 16209 2. Bestimmung des Verhaltens bei Stoßbeanspruchung mit einer kleinen Kugel gemäß den Prüfbedingungen der EN 438-2:2005, Abschnitt 20 3. Bestimmung der Kratzfestigkeit gemäß EN 15186 Verfahren B 4. Bestimmung der Tesaftigkeit gemäß IHD-W-463 und Beurteilung der Prüfflächen gemäß den Bewertungsstufen 5. Bestimmung des Verhaltens bei Abriebbeanspruchung nach EN 438-2:2005, Abschnitt 10 6. Bestimmung der Lichtechtheit gemäß DIN EN 438-2, Pkt. 27 7. Bestimmung des Verhaltens gegenüber Wasserdampf gemäß EN 438-2:2005, Abschnitt 14 8. Bestimmung des Verhaltens gegenüber trockener Hitze gemäß EN 12722/ Klassifizierung nach DIN 68861 Teil 7/ DIN CEN/TS 16209 9. Bestimmung des Verhaltens gegenüber feuchter Hitze gemäß EN 12721/ Klassifizierung nach DIN 68861 Teil 8/ DIN CEN/TS 16209 10. Bestimmung der Haftfestigkeit der Beschichtung in Anlehnung an DIN EN ISO 4624 11. Bestimmung der Wasserdampfdurchlässigkeit mittels Bestimmung der Wasseraufnahme bei einer Lagerung von 14 Tagen bei 20 °C/ 98 % relativer Luftfeuchte, Angabe der Wasseraufnahmemenge in g/m² 12. Bestimmung der Wischbeständigkeit nach IHD-W-471 		
<small>Der Prüfzettelbericht enthält 3 Seiten. Eine ausgewählte Vervielfältigung bedarf der schriftlichen Genehmigung des EPH. Die Prüfergebnisse beziehen sich ausschließlich auf die geprüften Materialien.</small>			

* except Duradecor ultra matt

Premium quality that you can feel in form and design

Your interior style sets the tone! Are you looking for residential internal doors that harmonise with your home? Get ready to be impressed by the high-quality Duradecor surface finish with vibrant colours, perfectly reproduced timber decors and expressive textures. You can also choose from numerous real lacquer surface finishes and real wood veneers. Or you can design your residential internal doors yourself with the paintable priming film. It doesn't get any more individual than that!





**Extremely
impact-resistant**

PERMANENT DURABILITY. With an impact resistance that is on average 48% better, the high-quality Duradecor surface finish is vastly superior to CPL surfaces from other manufacturers. It is also especially easy to clean, heat-resistant and almost as robust as a kitchen worktop.



No fingerprints

ULTRA MATT. Fingerprints on residential internal doors? Not with Duragrain ultra matt! That's because this surface finish combines high resistance to fingerprints and other soiling with an exquisite matt deluxe appearance in a previously unattainable matt finish. When it comes to both aesthetics and feel, the ultra matt surface finish is in a league of its own!



**Vibrant colour
coating**

VIBRANT COLOUR EFFECT. The lacquered surface of our timber doors has a classic and high-quality look. The even, multi-layer coating on the whole unit, made up of the door frame and door leaf, results in a uniform surface finish and a seamless edge transition. The deep and brilliant colour effect is truly impressive.

Impressive right down to the tiniest detail

We want our residential internal doors to impress you right down to the tiniest detail. You can enjoy your Hörmann residential internal doors for years to come thanks to standard features such as the 4Protect edge guard or our light-impermeable seal that blocks out light from an adjoining room for an undisturbed and restful night's sleep.





4Protect edge guard

RESISTANT EDGE. The standard 4Protect edge guard on flush-closing doors and rebated doors with angular edges offers a high resistance to impact, wear and scratches. This means that doors with a Duradecor surface finish are ideally protected against everyday wear and tear.

SEAMLESS WHITE. The rebate edge of all doors with a white Duradecor surface finish is specially coated for a seamless appearance. In addition, the 4Protect edge guard ensures a seamless transition to the door leaf in doors with angular edges. You can enjoy a continuously white door view without the bothersome unsightly edges typical of standard doors.



LIGHT-IMPERMEABLE WHITE SEAL. Hörmann's brand quality impresses with exquisite details. Take the standard light-impermeable seal for flush-closing doors, for example. With no visible light gap, you'll no longer be disturbed by light from the adjoining room.

The standard 4Protect edge guard impresses offers a seamless view without disrupting pencil edges on flush-closing doors and rebated doors with angular edges.

The standard light-impermeable seal on flush-closing doors blocks out light from the adjoining room.

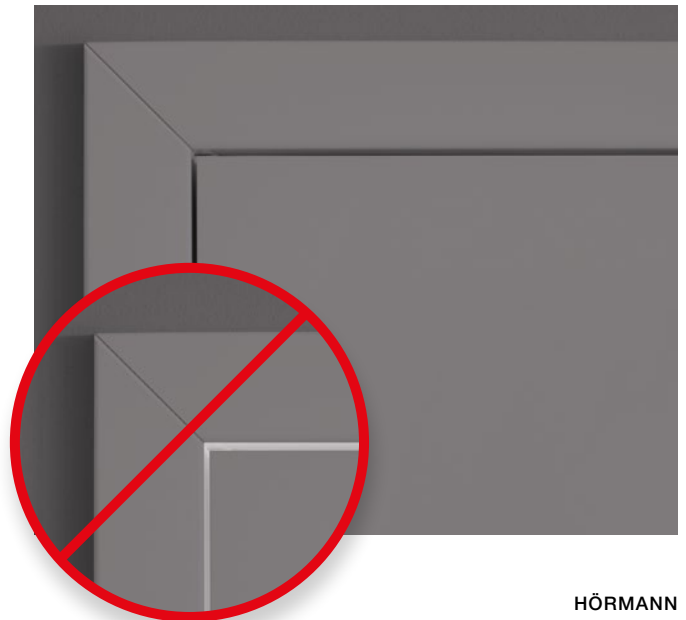

The long-lasting frame

Our high-quality timber and steel frames give your home twice the pep: the elegant, stylish appearance creates a pleasing ambience, and the frames are also extremely durable. Their high-quality, robust design makes them hard-wearing, and they are easy to clean and maintain over the long term.





HIGH-QUALITY TIMBER FRAME. The elegant 3 mm **1** edge radius impresses with a modern rectangular look and a seamless edge finish. The 25 mm-thick jamb lining **2** ensures high form stability, and the premium-quality Duradecor surface finish **3** also makes the frame particularly resistant to impacts and scratches.

→ For further information, see from page 98.



ROBUST STEEL FRAME VARIOFIX. All our residential internal doors are also available with the powder-coated VarioFix steel frame. The corner joints feature high-quality welding and a flush polish. This means that there are no visible mitre cuts in the frame corners. The robust frame construction can withstand run-ins with toy cars and vacuum cleaners. Thanks to the high-quality galvanisation, even cleaning solutions cannot damage the frame.

→ Further information can be found on page 103.



MINIMALISTIC ZEROLINE FRAME. The Zeroline frame **4** impresses with its clean lines and minimalist design, enabling a perfectly flush-fitting wall and door leaf, virtually invisible frame construction and concealed hinges (for comparison see Fig. **5** Standard frame with flush door leaf).

→ Further information can be found on page 104.







Inspirations

- 16 ProLine
- 18 Duradecor smooth surface finish
- 20 Door fittings black.edition
- 22 Real wood veneer surface finish
- 23 Duradecor texture surface finish
- 24 Duradecor ultra matt, Slate, Linen surface finish
- 26 Real lacquer surface finish
- 27 **NEW.** DesignLine Slat
- 28 DesignLine Plain
- 29 DesignLine Stripe 15
- 30 DesignLine Groove / **NEW.** DesignLine Line
- 32 Matching appearance for timber and glass doors
- 34 **NEW.** DesignLine Brisk
- 36 DesignLine Rail
- 37 **NEW.** DesignLine Palladio
- 38 ClassicLine Carolina
- 39 ClassicLine Georgia
- 40 ClassicLine Montana
- 41 ClassicLine Kontura
- 42 GlassLine
- 44 Steel loft doors
- 46 Sliding doors
- 50 Reverse timber door
- 51 Zeroline frame
- 52 Function and construction project doors
- 56 Accessories

ProLine

Do you value the feel-good factor in your home? Then the doors from the ProLine series are the perfect choice for you. The door leaf in a flush or rebated version creates a cosy atmosphere that invites you to relax.

→ Further information can be found starting on page 60.





PAGE 14 / 15 Flush-closing timber door ProLine Duradecor ultra matt Taupe

LEFT. Flush-closing timber door ProLine Duradecor White lacquer

TOP RIGHT. Rebated timber door ProLine Duradecor Light grey RAL 7035

BOTTOM RIGHT. **NEW.** Euro lever handle ProLock round with locking discreetly integrated into the handle

TOP LEFT. Rebated timber door ProLine
Duradecor French Beech

BOTTOM LEFT. Double-leaf rebated timber door
ProLine Duradecor White lacquer

RIGHT. Flush-closing timber door ProLine
Duradecor Dusty grey





Duradecor smooth surface finish

The extremely impact-resistant Duradecor surface finish is the right choice for your home. Whether you're keen on elegant White lacquer, modern grey or cosy timber decors, you're sure to find a residential internal door to suit your taste.

→ Further information can be found on page 78.



Door fittings black.edition

Do you love to see black in your home? Then our black.edition doors are the perfect choice for you. These doors feature striking details in elegant Jet black, subtly yet effectively embracing the latest design trend. Enhance your new residential internal doors with black door fittings, door hinges, lever handle sets and more. This creates a striking contrast, particularly when paired with white or grey surface finishes.

→ Further information can be found starting on page 88.



TOP LEFT. Flush-closing timber door ProLine, Duradecor Dusty grey, contrasting edge 4Protect in black

BOTTOM LEFT. Euro hinge concealed 3-way, black.edition in Jet black

RIGHT. Euro lever handle Pro round, black.edition in Jet black matt, magnet convenience lock black.edition, black contrasting edge



TOP LEFT. **NEW.** Detail view of Duradecor texture Black Oak

BOTTOM LEFT. Rebated timber door ProLine real wood veneer
White Oak matt, Listello

TOP RIGHT. **NEW.** Rebated timber door ProLine Duradecor
texture Black Oak

BOTTOM RIGHT. Flush-closing timber door ProLine Duradecor
Wild Oak with vertical grain, contrasting edge 4Protect in black

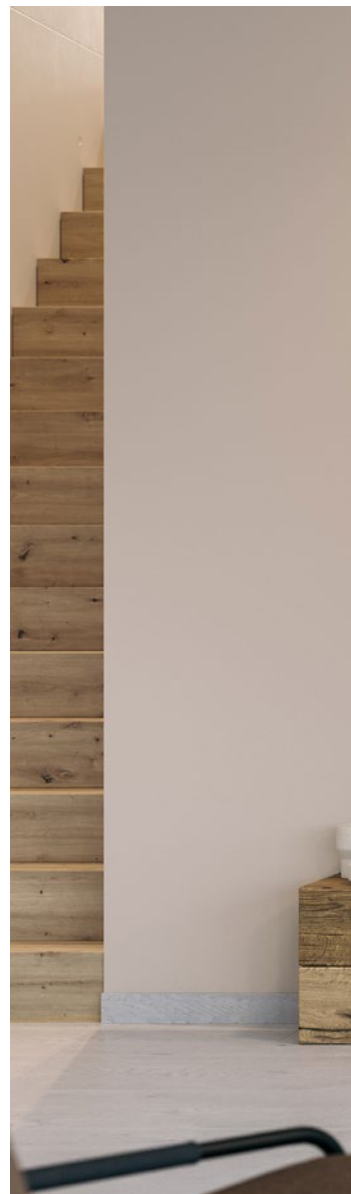

Real wood veneer surface finish

Natural, cosy, unique – real wood veneers are produced from high-quality precious woods and are truly unique.

→ Further information can be found on page 83.



Duradecor texture surface finish

This surface stylishly combines a feeling of real wood with ease of care. A wood grain texture is embossed into the door leaf, making the characteristic wood texture palpable.

→ Further information can be found on page 79.



TOP LEFT. Rebated timber door ProLine Linen Anthracite grey

TOP CENTRE LEFT. Detail view of Linen Anthracite grey

TOP CENTRE RIGHT. Flush-closing timber door ProLine Slate Dusty grey

TOP RIGHT. Detail view of Slate Dusty grey

BOTTOM. Flush-closing timber door ProLine ultra matt black





Ultra matt, Slate, Linen surface finish

The three unique surface finishes bring together a modern colour range featuring shades of white, taupe, dusty grey, anthracite grey and black. The ultra-matt surface finish stands out for its exceptional elegance, offering a silk matt look and feel with a depth of finish never seen before. We recommend the Slate textured surface finish for a modern yet cosy interior design. With its fine, tangible structure, the Linen surface finish blends particularly well with wood shades and suits a sophisticated, rustic-modern decorative style.

→ Further information can be found starting on page 80.



Real lacquer surface finish

Lacquered surface finishes with glossy or matt effects make your timber doors something rather special. The perfectly processed surface finish with an even coating and a seamless edge transition radiates simple elegance.

→ Further information can be found on page 82.



LEFT. Flush-closing timber door ProLine real lacquer Traffic white RAL 9016

TOP RIGHT. Flush-closing timber door DesignLine Slat real lacquer Anthracite grey RAL 7016, knotty oak matt real wool veneer insert

BOTTOM RIGHT. Detail view of knotty oak matt real wood veneer insert



NEW. DesignLine Slat

The doors of the DesignLine Slat have a minimalist appearance without conventional lever handles. Instead, a subtle insert in the door leaf acts as an unobtrusive handle bar, enhancing the minimalist, modern look. The handle bar is available in glass or any surface finish, matching the door leaf with a real lacquer surface finish for an elegant door view.

→ Further information can be found on page 61.

DesignLine Plain

The Plain style creates elegant accents with inlaid, flush-fitting applications. For a modern and exclusive door design, you can choose from 4 different applications: stainless steel , black , bronze or gold.

→ Further information can be found on page 63.



TOP. Flush-closing timber door DesignLine Plain real lacquer Traffic white RAL 9016, applications in black

BOTTOM. Rebated timber door DesignLine Stripe 15 Duradecor White lacquer



DesignLine Stripe 15

The Stripe 15 style with embossed grooves offers you a tasteful design with that little something extra. Flush-closing doors and rebated doors with angular edges are equipped with the high-quality 4Protect edge guard as standard.

→ Further information can be found on page 62.

DesignLine Groove / **NEW.** DesignLine Line

The grooves milled into the door leaf and the high-quality lacquer finish make the styles Groove and **NEW.** Line elegant eye-catchers. The DesignLine Groove stands out with its subtle V-groove **1**, while the DesignLine Line impresses with a striking U-groove **2**.

→ Further information can be found starting on page 64.





BOTTOM LEFT. Rebated timber door DesignLine
Groove 85 real lacquer Traffic white RAL 9016

TOP RIGHT. Rebated timber door DesignLine
Groove 107 real lacquer Traffic white RAL 9016

BOTTOM RIGHT. **NEW.** Rebated timber door
DesignLine Line 50 real lacquer Jet black RAL 9005



Matching appearance for timber and glass doors

Timber and glass doors with a matching appearance lend your entire home a seamless, harmonious look. The DesignLine Groove with matching glass doors is the ideal choice for a cohesive look throughout your home. The glass doors also blend harmoniously into the ambience with the Duradecor Slate and Linen designs, thanks to the same textured appearance.

→ Further information can be found starting on page 64.



TOP LEFT. Glass door GlassLine GrooveGlass 31 Black, flush-closing timber door DesignLine Groove 31 real lacquer black

TOP RIGHT. Rebated timber door ProLine Linen Anthracite grey RAL 7016 and glass door GlassLine Linen Anthracite grey RAL 7016

BOTTOM. Flush-closing timber door ProLine Duradecor Dusty grey RAL 7037 and glass door GlassLine Clear grey



TOP LEFT. Flush-closing timber door DesignLine Brisk 31 Duradecor real lacquer Traffic white RAL 9016 in combination with double-leaf Hörmann steel loft door with transom light

TOP RIGHT. Rebated timber door DesignLine Brisk 15 Duradecor Natural Oak textured

BOTTOM. Flush-closing timber door DesignLine Brisk 23 Duradecor Dusty grey





NEW. DesignLine Brisk

The doors of the DesignLine Brisk with black joints add stylish accents. The doors with black milled joints in a solid-coloured cover plate are available in over 40 styles and create an extremely elegant look when combined with the black.edition lever handles and fittings. The black joints also perfectly complement the Hörmann steel loft doors for a harmonious overall appearance. The combination with real wood veneers made from high-grade exotic woods appeals with its natural look and feel.

→ Further information can be found starting on page 64.

DesignLine Rail

We recommend the timber and glass combination as the perfect complement to the DesignLine timber door styles.

→ Further information can be found on page 68.

LEFT. Rebated timber door DesignLine Rail 1
Duradecor White lacquer RAL 9016, GrooveGlass 15
design glass

RIGHT. **NEW.** Flush-closing timber door DesignLine
Line Palladio real lacquer Jet black RAL 9005, loft
design 2-5 design glass





NEW. DesignLine Palladio

Let more light into your home with the DesignLine Palladio! The timber frame door with a real lacquer surface finish and full glazing elegantly blends transparency with robust stability for a generous amount of light. Customise your door and choose from a range of glass options, including clear glass, tinted glass or glass with black design elements in a modern loft design.

→ Further information can be found on page 69.

ClassicLine Carolina

The panel frames are created by embossed profiling in the door leaf. The high-quality lacquer coating means you can enjoy a smooth, vibrant colour surface. These especially cost-effective designs in a classic style are only available in our standard sizes.

→ Further information can be found on page 70.



TOP LEFT AND CENTRE. Rebated timber door
ClassicLine Carolina 1 real lacquer Traffic
white RAL 9016

TOP RIGHT. Rebated timber door ClassicLine
Georgia 2 real lacquer Taupe RAL 7048

BOTTOM LEFT. Double-leaf rebated timber
door ClassicLine Carolina 2 real lacquer
Traffic white RAL 9016

BOTTOM RIGHT. Detail view of ClassicLine
Georgia





ClassicLine Georgia

The high-quality profile strip is inlaid into grooves in the door leaf using traditional carpentry techniques, lending these styles a very elegant appearance that is the perfect match for classic interiors.

→ Further information can be found on page 71.

ClassicLine Montana

The high-quality finish of the frame look emphasises the simple elegance. The pared-back design suits both classic and modern interiors.

→ Further information can be found on page 72.



TOP LEFT. Detail view of ClassicLine Montana

TOP RIGHT. Double-leaf rebated timber door
ClassicLine Montana 2 real lacquer Traffic white
RAL 9016

BOTTOM LEFT. Rebated timber door ClassicLine
Kontura 4 real lacquer Jet black RAL 9005

BOTTOM RIGHT. Detail view of ClassicLine
Kontura

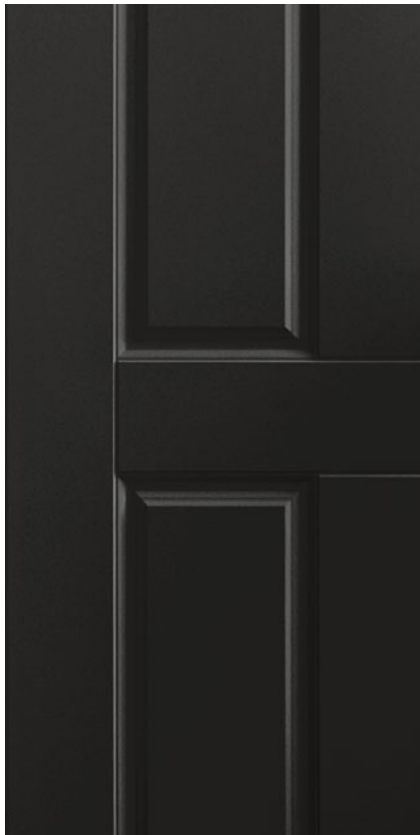

ClassicLine Kontura

The contour-milled profiles and slight V-groove lend the 46 mm-thick door leaf a particular charm, making it blend in perfectly with modern and period properties alike.

→ Further information can be found on page 73.

GlassLine

GlassLine doors offer you many clear advantages. Glass doors are elegant and chic. They give your home an open feeling and lend each room a very special charm. GlassLine is also particularly easy to clean: all the styles with sand-blasted glass feature nano coating – so you benefit from seeing hardly any fingerprints!

→ Further information can be found starting on page 74.





TOP. Glass door Gropus

BOTTOM LEFT. Glass door loft design 2-5

BOTTOM RIGHT. Glass door Clear grey



Steel loft doors

Do you value timeless elegance and modern minimalism? If so, our loft doors are perfect for you. The harmonious balance of steel and glass gives your interior design a special touch. The loft doors are available up to a door set size of 5000 × 4000 mm! Doors in this size are also very elegant thanks to their narrow profile view of 76 mm (door) and 20 mm (fixed glazing) and the surface-mounted rails.

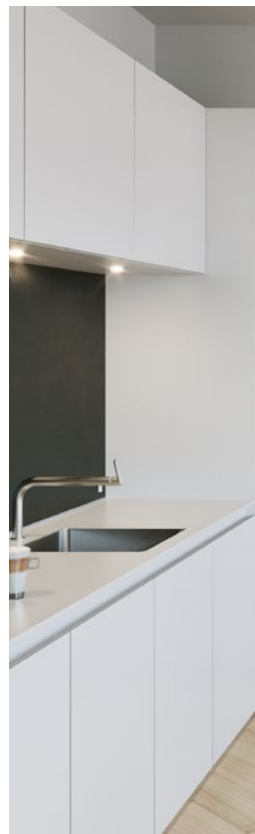

TOP LEFT. Single-leaf hinged door with side elements and transom light

TOP RIGHT. Double-leaf pivot door style 2

BOTTOM. Double-leaf sliding door with side elements

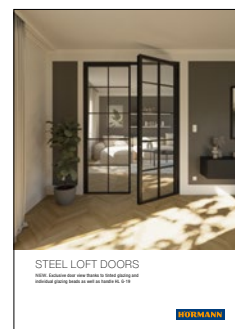

Further information can be found in the "Steel loft doors" brochure.

Sliding doors

TIMBER OR STEEL SLIDING DOOR FRAMES. Our single-leaf and double-leaf room solutions open up new possibilities for making ideal use of your living space. Timber frames in Duradecor smooth, Duradecor textured, Duradecor ultra matt, Slate, Linen and real lacquer or real wood veneer surface finishes create a harmonious whole with the door leaf. The robust steel frames feature an impressive high-quality coating.

→ Further information can be found on page 94.

LEFT. Timber frame type C with vertical stop, running in front of the wall, Duradecor textured Grey oak, bar handle Basic round stainless steel

RIGHT. Steel frames with high-quality coating in Traffic white RAL 9016, door leaf ClassicLine Georgia 1 Duradecor White lacquer, bar handle Basic round stainless steel



Timber sliding door frame versions running in front of the wall



Double-leaf sliding door, type A, running in front of the wall



Single-leaf sliding door, type B, running in front of the wall



Single-leaf sliding door, type C with vertical stop, running in front of the wall



SLIDING DOOR SYSTEM CORVARA. With its striking castors and stylish track profile, the Corvara sliding door system reinterprets industrial style. Matching accessories such as the flat handle in black.edition emphasise the exclusive feel.



LEFT. Corvara sliding door, Duradecor Wild Oak horizontal door leaf, Flat handle black.edition

TOP RIGHT. Slide Compact sliding door with glazed side element profile black.edition, Clear grey door leaf, Flat handle black.edition, fitting in the reveal

BOTTOM RIGHT. Slide Compact sliding door with vertical stop, GrooveGlass 85 door leaf, recessed handle 6402 stainless steel, fitting in front of the reveal





SLIDING DOOR SYSTEM SLIDE COMPACT. The track profile for the sliding door leaf is available in the surface finishes matt stainless steel, Jet black or White. The profile can be fitted both in front of the wall and in the reveal. With a glazed side element, the system presents a translucent, space-saving door solution for wide passages. For a door leaf weight of up to 60 kg, the Slide Compact system is equipped with a SafeClose in order to gently close the door leaves.

→ Further information can be found on page 94.

Reverse timber door

This door version boasts an almost flush-fitting transition between door leaf and frame on the hallway side, opening through the frame into the room beyond at the same time. As with flush-closing doors, you can achieve an eye-catching door view in the hallway.

→ Further information can be found on page 105.





LEFT. Flush-closing timber doors Reverse with reveal rebate, real lacquer Traffic white RAL 9016, lever handle Linea matt stainless steel

RIGHT. Flush-closing timber doors with Zeroline frame, real lacquer Traffic white RAL 9016, lever handle Linea black matt

Zeroline frame

The Hörmann Zeroline frame is the perfect choice for all connoisseurs of clear design language. The cleverly conceived structure captivates with a minimalist design that enables a flush-fitting door leaf and features a virtually invisible frame construction owing to a frame face of just 2 mm, plus concealed hinges. The result is a door / frame combination that meets even the most exacting design demands.

→ Further information can be found on page 104.

Function and construction project doors

TIMBER CONSTRUCTION PROJECT DOORS. For all requirements in commercial and residential construction, our timber doors can be equipped with additional functions such as fire protection, security or acoustic insulation. Doors are especially exposed to stress in schools, nurseries, offices and hotels. To meet these demands, we have developed our premium-quality DuraProject door surface finish that offers the same product properties as an HPL surface.

→ Further information can be found starting on page 106.

Functions at a glance



Fire and smoke protection

Fire protection can save lives! A suitably equipped door can protect against penetrating flames (for at least 30 or 90 minutes) as well as prevent the penetration of dangerous combustion gases. Fire-rated / smoke-tight door sets are only available as a complete package which includes the door frame and all door fittings.



Acoustic insulation

Acoustic-rated doors are in demand in areas such as apartments or offices where noise levels can be high. The connection between the door and frame is crucial here. It is an essential component for guaranteeing the required acoustic insulation.



Safety

Suitable special functions can significantly reduce the risk of burglary. Hörmann recommends resistance class RC 2 or, even better, RC 3 for apartment entrance doors.



Climatic class 3

Doors in this class feature a special door leaf construction that balances the temperature and moisture differences between rooms with different uses, such as between an unheated cellar and a warm hallway.

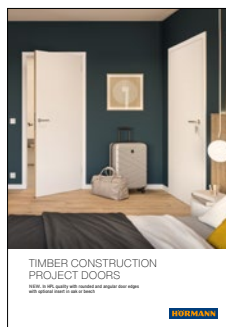

For further information on DuraProject, see the brochure.

TOP RIGHT. Timber double-action door HPH-180 with profile frame

BOTTOM. Flush-closing timber door, DuraProject White lacquer





Double-action doors

Double-action doors are particularly suited to situations where there is no 'free hand', such as when serving food and drinks in restaurants and canteen kitchens: they open smoothly and easily. The HPL or timber double-action doors are a real eye-catcher for catering and shopfitting applications.



DOUBLE-ACTION DOORS

WWW.HOERMANN-DOORS.COM

HOERMANN









For further information on double-action doors, see the brochure.



CLIMATE AND APARTMENT ENTRANCE DOORS. For multiple-occupancy dwellings, our doors offer high acoustic insulation levels, a reliable function even when temperatures in the hallway differ from those inside the rooms, plus certified security. Choose from three equipment packages for added security and convenience.

→ Further information can be found starting on page 106.

Climate and apartment entrance doors

	WET system 1*	WET system 2*	WET system 3*
 Climatic class 3	●	●	●
 Acoustic rating category 1	●	-	-
 Acoustic rating category 2	-	●	-
 Acoustic rating category 3	-	●	●
 RC2 security features	-	○	○
 RC3 security features	-	-	●

● = Standard equipment ○ = Optional equipment

* only ProLine



GARAGE CONNECTING DOORS. Fire protection of at least 30 minutes is required by law at the point where the garage transitions to the living area. The standard smoke protection offers protection from exhaust fumes and the optional acoustic insulation function helps block out intrusive engine noise. The garage connecting door is equipped with RC2 security features as standard. The optional RC3 equipment provides extra security.

→ Further information can be found starting on page 106.

LEFT. Rebated apartment entrance door WET 3 ProLine, Duradecor White lacquer, protective fitting matt stainless steel

BOTTOM. Rebated garage connecting door, Duradecor White lacquer, lever handle Linea matt stainless steel



Accessories

DOOR OPERATOR PORTAMATIC. Open and close your residential internal doors easily and automatically via a hand transmitter or button. Whether you are physically disabled or would simply like more convenience, this technology is sure to make your everyday life easier. The door operator PortaMatic not only features an array of functions and settings but also minimal power consumption. In addition, the PortaMatic is up to 25% cheaper than similar door operators and can be subsidised up to 100% by your nursing care insurance.



Find out more about support options at www.hormann.co.uk/home-owners-and-renovators/operators/internal-door-operators





TOP LEFT. Rebated timber door DesignLine Stripe 15, Duradecor White lacquer with SmartKey door lock operator in white

TOP RIGHT. SmartKey door lock operator in white

BOTTOM LEFT. PortaMatic door operator in white

BOTTOM RIGHT. Rebated timber door ProLine, Duradecor White lacquer with PortaMatic door operator in white

DOOR LOCK OPERATOR SMARTKEY. Easily open your door lock at the press of a button with your hand transmitter, radio internal push button or directly via the sensor field on the SmartKey. So there's no need to put down your shopping in order to open your door. Even with a walker, wheelchair or pram, it is much easier to enter your house or apartment because you can open the door from a distance. Locking takes place either by pressing a button or automatically after a specified period of time. This securely locks your door and provides the greatest possible protection against burglary.

→ Further information can be found on page 107.





Design Equipment Accessories

- 60 ProLine
- 61 **NEW.** DesignLine Slat
- 62 DesignLine Stripe 15
- 63 DesignLine Plain
- 64 DesignLine Groove / **NEW.** Line / **NEW.** Brisk
- 68 DesignLine Rail
- 69 **NEW.** DesignLine Palladio
- 70 ClassicLine Carolina
- 71 ClassicLine Georgia
- 72 ClassicLine Montana
- 73 ClassicLine Kontura
- 74 GlassLine



- 78 Duradecor smooth
- 79 Duradecor texture
- 80 Duradecor ultra matt, Slate, Linen
- 82 Real lacquer
- 83 Real wood veneer

- 84 Lever handle sets and door fittings
- 88 Door fittings black.edition
- 91 **NEW.** Brass door fittings
- 92 Lever handle sets and door fittings for glass doors
- 94 Door fittings and handles for sliding doors
- 96 Glazing cut-outs, side elements, transom lights
- 98 Door and frame design
- 100 Door and frame types
- 103 VarioFix steel frame
- 104 Zeroline frame
- 105 Reverse timber door
- 106 Function and construction project doors
- 108 Dimensions and technical manual







ProLine

Duradecor surface finishes, real lacquer, real wood veneers

Door versions

-  Rebated with rounded edges
-  Rebated with angular edges
-  Flush











Duradecor smooth

-  White lacquer RAL 9016
-  **NEW.** White lacquer RAL 9010
-  White Parchment
-  Light grey RAL 7035
-  Dusty grey RAL 7037
-  French Beech









Duradecor ultra matt, Slate, Linen

-  White
-  Taupe
-  Dusty grey
-  Anthracite grey
-  Black













Duradecor texture

-  Grey Oak
-  Wild Oak
-  Brushed White
-  Brushed Pine
-  Brushed Salted Oak
-  Brushed Larch, light
-  Alpine Oak
-  North Oak
-  Natural Oak
-  White Oak
-  **NEW.** Black Oak

Real lacquer / real lacquer matt

-  Traffic white RAL 9016
-  Pure white RAL 9010
-  Light grey RAL 7035
-  Taupe RAL 7048
-  Dusty grey RAL 7037
-  Anthracite grey RAL 7016
-  Jet black RAL 9005
-  RAL to choose (not for real lacquer matt)

Real wood veneers

-  Canadian Maple matt
-  Beech matt
-  White Oak matt
-  Knotty Oak matt
-  Limba matt
-  Sapeli matt
-  Core Beech matt
-  American Cherry Tree matt
-  American Walnut matt
-  European Oak planked matt
-  Wild Oak matt
-  Smoked Oak matt



Rebated, single-leaf



Rebated, double-leaf



Flush, single-leaf



Flush, double-leaf

All doors in Duradecor smooth, White lacquer RAL 9016

NEW. DesignLine Slat

Real lacquer surface finish

Door versions



Flush



Real lacquer / real lacquer matt



Traffic white RAL 9016



Pure white RAL 9010



Light grey RAL 7035



Taupe RAL 7048



Dusty grey RAL 7037



Anthracite grey RAL 7016



Jet black RAL 9005



RAL to choose (not for real lacquer matt)



Real lacquer Jet black RAL 9005, insert in knotty oak matt real wood veneer



Real lacquer Taupe RAL 7048, insert in Duradecor Grey Oak



Real lacquer Jet black RAL 9005, insert in Dusty grey RAL 7037



Real lacquer Traffic white RAL 9016, insert in matt-textured glass



Real lacquer Dusty grey RAL 7037, insert in Duradecor Linen Dusty grey RAL 7037



Real lacquer Light grey RAL 7035, insert in Jet black RAL 9005



The recess in the door leaf replaces the lever handle.

DesignLine Stripe 15

Duradecor surface finish

Door versions



Rebated with angular edges



Flush



Duradecor smooth



White lacquer RAL 9016



Dusty grey RAL 7037



Stripe 15
Duradecor
Dusty grey RAL 7037



Stripe 15
Duradecor
White lacquer
RAL 9016

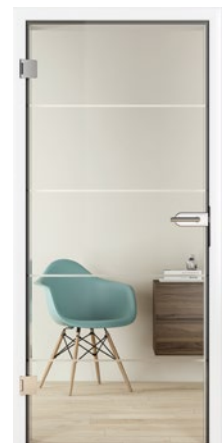

Matching glass door
GrooveGlass 15 / 5
Clear glass surface
(single-pane safety
glass) with matt style
(silkscreen), stripe width
5 mm



Embossed grooves make it a real eye-catcher

DesignLine Plain

Duradecor surface finishes, real lacquer

Door versions



Rebated with rounded edges



Rebated with angular edges



Flush



Duradecor smooth



White lacquer RAL 9016



NEW. White lacquer RAL 9010



White Parchment



Light grey RAL 7035



Dusty grey RAL 7037



French Beech



Duradecor texture



Grey Oak



Wild Oak



Brushed White



Brushed Pine



Brushed Salted Oak



Brushed Larch, light



Alpine Oak



North Oak



Natural Oak



White Oak



NEW. Black Oak



Real lacquer / real lacquer matt



Traffic white RAL 9016



Pure white RAL 9010



Light grey RAL 7035



Taupe RAL 7048



Dusty grey RAL 7037



Anthracite grey RAL 7016



Jet black RAL 9005



RAL to choose (not for real lacquer matt)



Plain 14-7
Duradecor White lacquer RAL 9016



Plain 23-7
Duradecor White lacquer RAL 9016



Plain 27-7
Real lacquer Traffic white RAL 9016 with black applications, door fittings black.edition



Plain 14-7
Duradecor Dusty grey RAL 7037

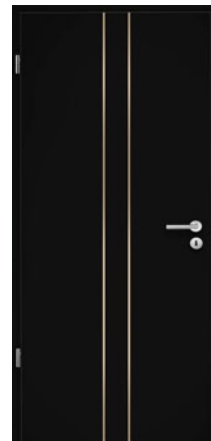

Plain 23-7
Real lacquer Jet black RAL 9005



Matching glass door **loft design 1-5**
Clear glass surface (single-pane safety glass) with black lines (textured lacquer)

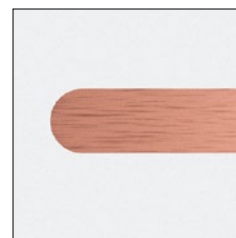
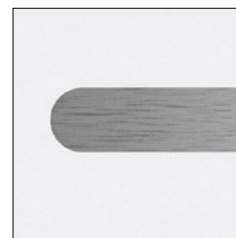



Modern and exclusive door design with 4 different applications: stainless steel, black, bronze or gold

DesignLine Groove / Line / Brisk

Duradecor surface finishes, real lacquer, real wood veneers

Door versions

 Rebated with rounded edges
(DesignLine Groove and Line only)

 Rebated with angular edges

 Flush

 **Duradecor smooth**
(DesignLine Brisk only)

 White lacquer RAL 9016

 Dusty grey RAL 7037

 **Duradecor texture**
(DesignLine Brisk only)

 Wild Oak

 Alpine Oak

 North Oak

 Natural Oak

 **Real lacquer / real lacquer matt**

 Traffic white RAL 9016

 Pure white RAL 9010

 Light grey RAL 7035

 Taupe RAL 7048

 Dusty grey RAL 7037

 Anthracite grey RAL 7016

 Jet black RAL 9005

 RAL to choose (not for real lacquer matt)

 **Real wood veneers**
(DesignLine Brisk only)

 Canadian Maple matt

 Beech matt

 White Oak matt

 Knotty Oak matt

 Limba matt

 Sapeli matt

 Core Beech matt

 American Cherry Tree matt

 American Walnut matt

 European Oak planked matt

 Wild Oak matt

 Smoked Oak matt

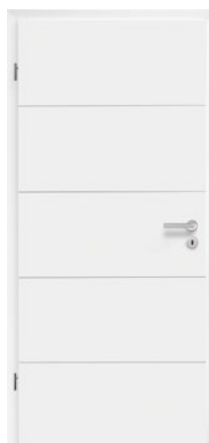

Groove 15



DesignLine Groove with 4.5 mm wider V-groove



NEW. Line 15



NEW. DesignLine Line with 9 mm wider U-groove



NEW. Brisk 15



NEW. DesignLine Brisk with black V-groove



**Groove / Line /
Brisk 13**



**Groove / Line /
Brisk 14**

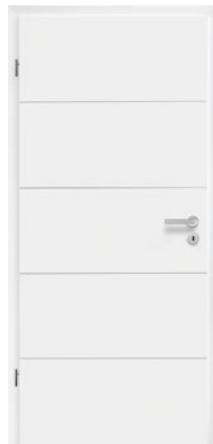

**Groove / Line /
Brisk 15**



GrooveGlass 15 / 5
Matt glass surface
(single-pane safety glass,
sand-blasted) with clear
style, stripe width 5 mm



GrooveGlass 15 / 5
Clear glass surface
(single-pane safety glass)
with matt style (silkscreen),
stripe width 5 mm



**Groove / Line /
Brisk 16**



**Groove / Line /
Brisk 19**



**Groove / Line /
Brisk 20**

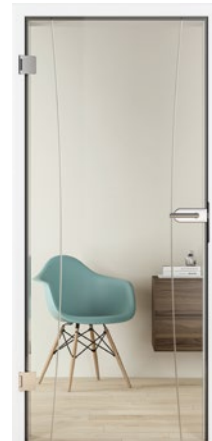

GrooveGlass 20
Clear glass surface
(single-pane safety glass)
with matt style (V fluted
glass)



GrooveGlass 20
Matt glass surface
(single-pane safety glass,
sand-blasted) with clear
style



**Groove / Line /
Brisk 21**



**Groove / Line /
Brisk 22**



**Groove / Line /
Brisk 23**



**Groove / Line /
Brisk 27**



**Groove / Line /
Brisk 29**

All timber doors in real lacquer, Traffic white RAL 9016

DesignLine Groove / Line / Brisk

Duradecor surface finishes, real lacquer, real wood veneers



GrooveGlass 29
Clear glass surface
(single-pane safety glass)
with matt style (sand-
blasted)



GrooveGlass 29 Black
Clear glass surface
(single-pane safety glass)
with black lines (textured
lacquer)



**Groove / Line /
Brisk 31**



GrooveGlass 31 Black
Clear glass surface
(single-pane safety glass)
with black lines (textured
lacquer)



**Groove / Line /
Brisk 34**



GrooveGlass 50 Black
Clear glass surface
(single-pane safety glass)
with black lines (textured
lacquer)



**Groove / Line /
Brisk 51**



GrooveGlass 51
Matt glass surface
(single-pane safety glass,
silkscreen) with clear style



**Groove / Line /
Brisk 53**



**Groove / Line /
Brisk 54**



**Groove / Line /
Brisk 88**



**Groove / Line /
Brisk 89**



**Groove / Line /
Brisk 92**



**Groove / Line /
Brisk 95**



**NEW. Groove / Line /
Brisk 99**

All timber doors in real lacquer, Traffic white RAL 9016



Groove / Line /
Brisk 39



Groove / Line /
Brisk 44



Groove / Line /
Brisk 49



Groove / Line /
Brisk 50

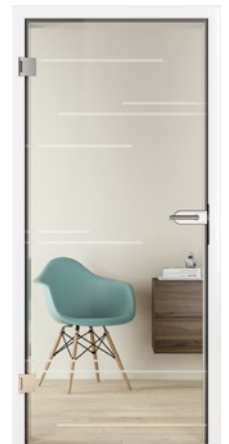

GrooveGlass 50
Clear glass surface
(single-pane safety glass)
with matt style (sand-
blasted)



NEW. Groove / Line /
Brisk 58



NEW. Groove / Line /
Brisk 59



Groove / Line /
Brisk 78



Groove / Line /
Brisk 85



GrooveGlass 85
Matt glass surface
(single-pane safety glass,
sand-blasted) with clear
style



Groove / Line /
Brisk 101



Groove / Line /
Brisk 102



Groove / Line /
Brisk 103



Groove / Line /
Brisk 104



Groove / Line /
Brisk 107

DesignLine Rail

Duradecor surface finishes, real lacquer

Door versions



Rebated with rounded edges



Rebated with angular edges



Flush



Duradecor smooth



White lacquer RAL 9016



NEW. White lacquer RAL 9010



White Parchment



Light grey RAL 7035



Dusty grey RAL 7037



French Beech



Rail 1
Clear glass
(Clear or Clear white)



Rail 2
Matt glass
(satin-finished glass or silkscreen)



Rail 1
Design glass



Duradecor ultra matt, Slate, Linen



White



Taupe



Dusty grey



Anthracite grey



Black



Duradecor texture



Grey Oak



Wild Oak



Brushed White



Brushed Pine



Brushed Salted Oak



Brushed Larch, light



Alpine Oak



North Oak



Natural Oak



White Oak



NEW. Black Oak



Real lacquer / real lacquer matt



Traffic white RAL 9016



Pure white RAL 9010



Light grey RAL 7035



Taupe RAL 7048



Dusty grey RAL 7037



Anthracite grey RAL 7016



Jet black RAL 9005



RAL to choose (not for real lacquer matt)

Design glasses



Gisa



Gropus
Matt glass surface



GrooveGlass 15
Matt glass surface



Jil
Matt glass surface

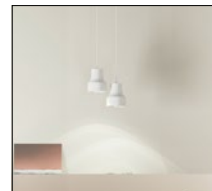

GrooveGlass 29
Matt glass surface



Raff
Matt glass surface

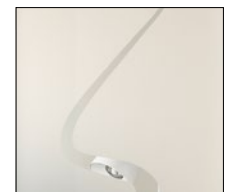

Wave
Matt glass surface

NEW. DesignLine Palladio

Duradecor surface finishes, real lacquer







Door versions



Flush



Duradecor smooth

-  White lacquer RAL 9016
-  **NEW.** White lacquer RAL 9010
-  White Parchment
-  Light grey RAL 7035
-  Dusty grey RAL 7037
-  French Beech



Duradecor ultra matt, Slate, Linen

-  White
-  Taupe
-  Dusty grey
-  Anthracite grey
-  Black



Real lacquer / real lacquer matt

-  Traffic white RAL 9016
-  Pure white RAL 9010
-  Light grey RAL 7035
-  Taupe RAL 7048
-  Dusty grey RAL 7037
-  Anthracite grey RAL 7016
-  Jet black RAL 9005



RAL to choose (not for real lacquer matt)



Palladio 1
Clear glass



Palladio 1
Matt glass



Palladio 1
Loft design 1-5



Palladio 1
Loft design 2-5



Palladio 1
Loft design 3-5

ClassicLine Carolina

Real lacquer surface finish

Door versions



Rebated with rounded edges



Real lacquer / real lacquer matt



Traffic white RAL 9016



Pure white RAL 9010



Light grey RAL 7035



Taupe RAL 7048



Dusty grey RAL 7037



Anthracite grey RAL 7016



Jet black RAL 9005



RAL to choose (not for real lacquer matt)



Carolina 1



Carolina 1
With glazing cut-out
Lugano



Carolina 2



Carolina 2
With glazing cut-out
LA 2



Carolina 4

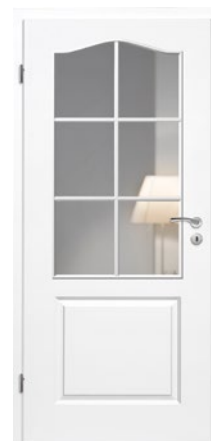

Carolina 4
With glazing cut-out LA
rail 2 / 3



High-quality panel frames are created by embossed profiling in the door leaf





Carolina 5

All doors in real lacquer, Traffic white RAL 9016







ClassicLine Georgia

Duradecor surface finishes, real lacquer







Door versions

-  Rebated with rounded edges
-  Rebated with angular edges
-  Flush

Duradecor smooth

-  White lacquer RAL 9016
-  **NEW.** White lacquer RAL 9010
-  White Parchment
-  Light grey RAL 7035
-  Dusty grey RAL 7037
-  French Beech

Real lacquer / real lacquer matt

-  Traffic white RAL 9016
-  Pure white RAL 9010
-  Light grey RAL 7035
-  Taupe RAL 7048
-  Dusty grey RAL 7037
-  Anthracite grey RAL 7016
-  Jet black RAL 9005

 RAL to choose (not for real lacquer matt)



Georgia 1



Georgia 2
With glazing cut-out



Georgia 3



Georgia 4



Georgia 4
With glazing cut-out



Georgia 5



Profile strip inlaid into a groove in the door leaf using traditional carpentry techniques

All doors in real lacquer, Traffic white RAL 9016

ClassicLine Montana

Real lacquer surface finish

Door versions



Rebated with rounded edges



Real lacquer / real lacquer matt



Traffic white RAL 9016



Pure white RAL 9010



Light grey RAL 7035



Taupe RAL 7048



Dusty grey RAL 7037



Anthracite grey RAL 7016



Jet black RAL 9005



RAL to choose (not for real lacquer matt)



Montana 1
With glazing cut-out



Montana 2



Montana 3



Montana 4
With glazing cut-out



Montana 5

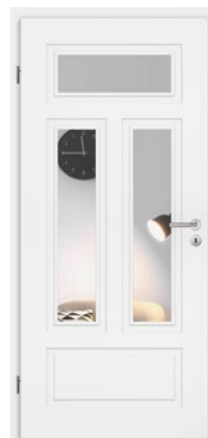

Montana 6
With glazing cut-out



High-quality finish of the frame look

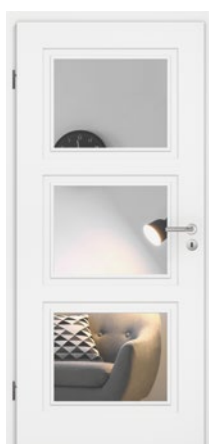

Montana 7
With glazing cut-out



Montana 8

All doors in real lacquer, Traffic white RAL 9016

ClassicLine Kontura

Real lacquer surface finish

Door versions



Rebated with rounded edges



Real lacquer / real lacquer matt



Traffic white RAL 9016



Pure white RAL 9010



Light grey RAL 7035



Taupe RAL 7048



Dusty grey RAL 7037



Anthracite grey RAL 7016



Jet black RAL 9005



RAL to choose (not for real lacquer matt)

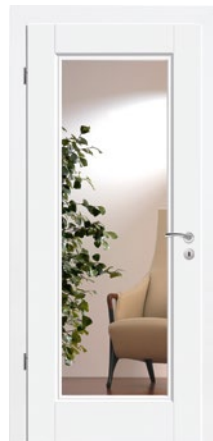

Kontura 1
With glazing cut-out LA



Kontura 2



Kontura 3
With glazing cut-out LA



Kontura 4



Kontura 5



Contour-milled profiles with subtle V-groove

All doors in real lacquer, Traffic white RAL 9016

GlassLine

More light for your home



Laser technique

This glass finish offers fine details and shading. The depth effect creates fascinating impressions that are further enhanced by the brilliance of the glass door.



Glass type Clear

With this glass type, the glass door creates a subtle, interesting contrast. The iron oxide in the glass produces a slight "green shimmer".



Sand-blasting

For those who value individuality, the sandblasting technique draws delicate designs in the glass surface. The matt surface finish with nano coating guarantees fewer fingerprints.

Tip

Fewer fingerprints thanks to nano coating



Glass type Clear White

The Clear White glass type creates an almost colour-neutral transparency.



Silkscreen

Design meets superior surface finishing: the highly scratch-resistant surface is easy to clean and resistant to soiling.

Tip

Particularly easy to clean



Single-pane safety glass

All glass doors with styles feature 8-mm-thick single-pane safety glass. This glass type is also available in tinted or solid matt versions, as well as in a cool loft design.



Fluted glass

The fluted glass on the glass door is created by a fine V-groove. A clear or satin-finished glass is used depending on the preferred opaqueness. The fluted glass impresses with special patterns, its tactile feel and the extraordinary play of light produced by the prism effect.



Laminated safety glass

This 10-mm-thick glass type consists of 2 panes that are firmly connected with a colour or matt plastic film.



Agesa
Clear glass surface (single-pane safety glass) with matt style (laser technology)



Gropus
Clear glass surface (single-pane safety glass) with style (fluted glass)



Gropus
Matt glass surface (single-pane safety glass, satin-finished glass) with style (fluted glass)



Jada
Clear glass surface (single-pane safety glass) with matt style (sand-blasted)



Jil
Clear glass surface (single-pane safety glass) with matt style (sand-blasted)



Jil
Matt glass surface (single-pane safety glass, sand-blasted) with clear style



Liko
Clear glass surface (single-pane safety glass) with matt style (sand-blasted)



Liko
Matt glass surface (single-pane safety glass, sand-blasted) with clear style



Privat
Matt glass surface (single-pane safety glass, sand-blasted) with clear style as desired



Raff
Clear glass surface (single-pane safety glass, sand-blasted, optionally in silkscreen) with matt style



Raff
Matt glass surface (single-pane safety glass, sand-blasted) with clear style



Wave
Clear glass surface (single-pane safety glass) with matt style (sand-blasted)



Wave
Matt glass surface (single-pane safety glass, sand-blasted, optionally in silkscreen) with clear style



Slate
Clear glass surface (single-pane safety glass) with digital print motif in Black, Anthracite grey, Dusty grey, Taupe or White (shown)



Linen
Clear glass surface (single-pane safety glass) with digital print motif in Black, Anthracite grey, Dusty grey, Taupe or White (shown)

GlassLine

More light for your home



Clear
Clear glass surface
(single-pane safety glass
or laminated safety glass
with plastic film inside)



Clear bronze
Tinted glass surface
(single-pane safety glass)

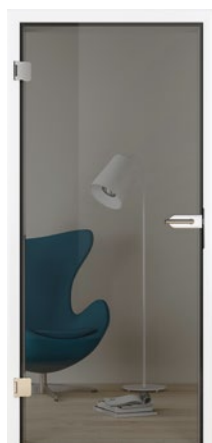

Clear grey
Tinted glass surface
(single-pane safety glass)

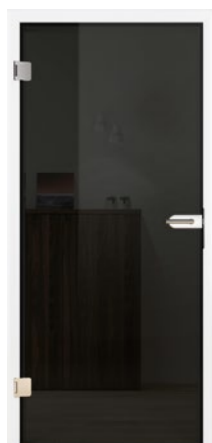

Dark grey
Tinted glass surface
(single-pane safety glass)



Master-Carré
Glass surface (single-pane
safety glass, Master-
Carré)



Solid silkscreen
Solid matt glass surface
(single-pane safety glass,
silkscreen)



Satin-finished glass
Matt glass surface
(single-pane safety glass,
satin-finished glass)



Satin-finished look
Matt glass surface
(laminated safety glass
with plastic film inside)



White
Glass surface (laminated
safety glass) with coloured
plastic film inside



Black
Glass surface (laminated
safety glass) with coloured
plastic film inside



NEW. Customised glass styles

Design your glass door in your favourite style with digital printing. Your home will have a unique flair. Talk to your Hörmann sales partner about the wide range of options available.



Loft design 1-1
Clear glass surface
(single-pane safety glass)
with black edge



Loft design 1-5
Clear glass surface
(single-pane safety glass)
with black lines



Loft design 2-5
Clear glass surface
(single-pane safety glass)
with black lines



Loft design 3-5
Clear glass surface
(single-pane safety glass)
with black lines



Loft design 1-1
Matt glass surface
(satin-finished glass) with
black edge



Loft design 1-5
Matt glass surface
(satin-finished glass) with
black lines



Loft design 2-5
Matt glass surface
(satin-finished glass) with
black lines



Loft design 3-5
Matt glass surface
(satin-finished glass) with
black lines



Loft design 1-1
Tinted glass surface Clear
grey (single-pane safety
glass) with black edge



Loft design 1-5
Tinted glass surface Clear
grey (single-pane safety
glass) with black lines



Loft design 2-5
Tinted glass surface Clear
grey (single-pane safety
glass) with black lines

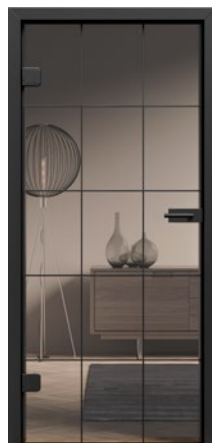

Loft design 3-5
Tinted glass surface Clear
grey (single-pane safety
glass) with black lines

Duradecor smooth

Permanent durability

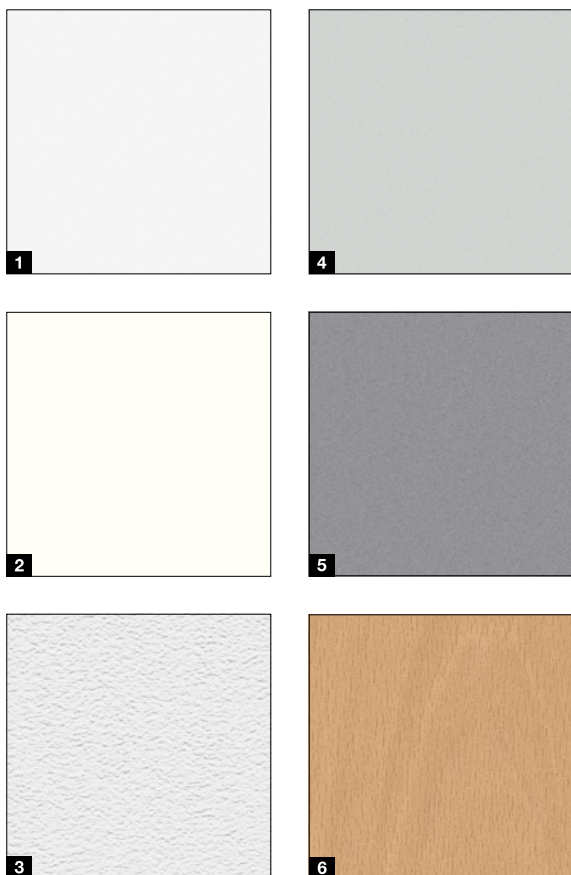

Extremely impact-resistant



4Protect edge guard

The extremely impact-resistant Duradecor surface finish is the right choice for your home. Whether you're keen on elegant White lacquer, modern grey or cosy timber decors, you're sure to find a residential internal door to suit your taste. Our flush-closing doors and rebated doors with angular edges in the Duradecor surface finishes White lacquer, Light grey, Dusty grey, White Parchment and White Ash are equipped with the high-quality 4Protect edge guard as standard.

- 1** White lacquer RAL 9016
- 2** **NEW.** White lacquer RAL 9010
- 3** White Parchment
- 4** Light grey RAL 7035
- 5** Dusty grey RAL 7037
- 6** French Beech

The colours and decors shown are subject to the limitations of the printing process and cannot be regarded as binding. All RAL colours based on RAL colour chart. **Please consult with your local Hörmann sales partner.**

Duradecor texture

Characteristic wood texture



Extremely impact-resistant



4Protect edge guard

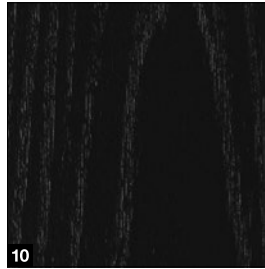
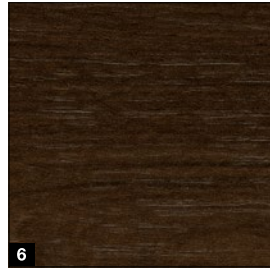

This surface stylishly combines a feeling of real wood with ease of care. A wood grain texture is embossed into the door leaf, making the characteristic wood texture palpable. Flush-closing doors and rebated doors with angular edges in the Duradecor texture surface finish Brushed White are equipped with the high-quality 4Protect edge guard as standard.



- 1** Grey Oak*
- 2** Wild Oak*
- 3** Brushed White*
- 4** Brushed Pine
- 5** Brushed Salted Oak*
- 6** Alpine Oak*
- 7** North Oak*
- 8** Natural Oak*
- 9** White Oak
- 10** **NEW.** Black Oak



The decors shown are subject to the limitations of the printing process and cannot be regarded as binding. **Please consult with your local Hörmann sales partner.**

* also with vertical grain

Duradecor ultra matt, Slate, Linen

Harmoniously coordinated surface finishes and colours

Ultra matt

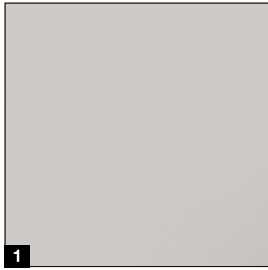

Extremely impact-resistant



4Protect edge guard



No fingerprints

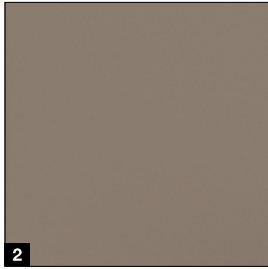

This particularly elegant surface finish will impress even the most discerning customers in terms of both aesthetics and feel. Ultra matt combines high resistance to fingerprints and other soiling with an exquisite matt deluxe appearance in a previously unattainable matt finish.

- 1** White
- 2** Taupe
- 3** Dusty grey
- 4** Anthracite grey
- 5** Black

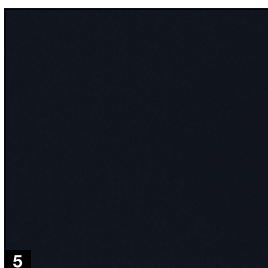
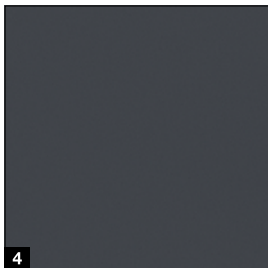

The colours and decors shown are subject to the limitations of the printing process and cannot be regarded as binding. **Please consult with your local Hörmann sales partner.**

Slate

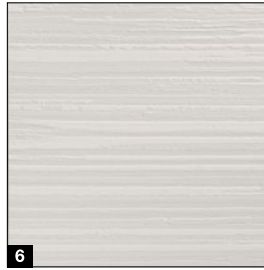

Extremely impact-resistant



4Protect edge guard



We recommend this textured surface finish for a modern yet cosy interior design. The light-shadow contrast on the raised texture gives it a very pleasant and natural vibrant appearance. This variant is also available as a glass door.

- 6** White
- 7** Taupe
- 8** Dusty grey
- 9** Anthracite grey
- 10** Black

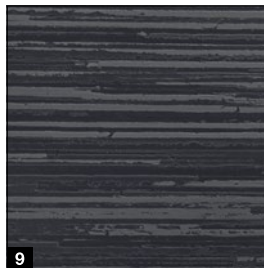
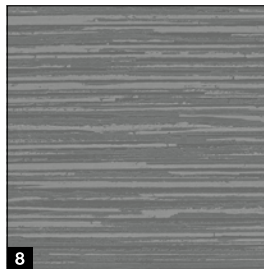

The colours and decors shown are subject to the limitations of the printing process and cannot be regarded as binding. **Please consult with your local Hörmann sales partner.**

Linen

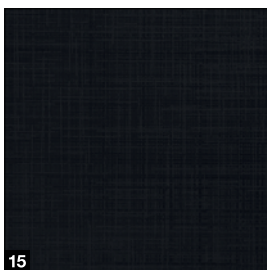
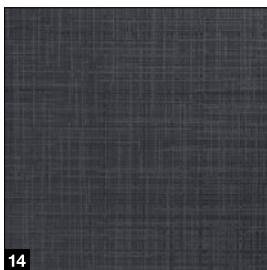
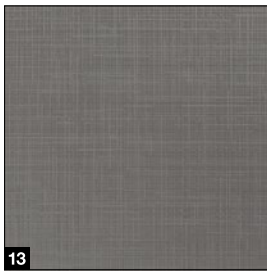
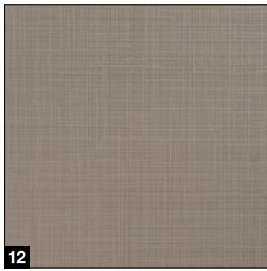
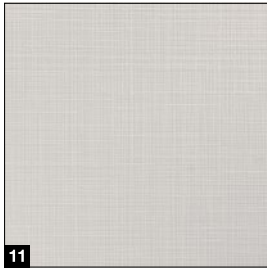

Extremely impact-resistant



4Protect edge guard

With its fine, tangible structure, the Linen surface finish blends particularly well with wood shades and suits a sophisticated, rustic-modern decorative style. At the same time, the surface is robust and easy-to-clean. The Linen surface finish is also available to choose as a glass door.

11 White

12 Taupe

13 Dusty grey

14 Anthracite grey

15 Black

The colours and decors shown are subject to the limitations of the printing process and cannot be regarded as binding. **Please consult with your local Hörmann sales partner.**

Matching appearance for glass doors



DesignLine Slate
in Black, Anthracite grey, Dusty grey, Taupe (shown) or White



GlassLine slate
Clear glass surface (single-pane safety glass) with digital print motif in Black, Anthracite grey, Dusty grey, Taupe (shown) or White



DesignLine Linen
in Black, Anthracite (shown), Dusty grey, Taupe or White



GlassLine Linen
Clear glass surface (single-pane safety glass) with digital print motif in Black, Anthracite (shown), Dusty grey, Taupe or White

Real lacquer / real lacquer matt

Glossy colour effect and stylish matt finish



Vibrant colour coating



RAL to choose
(not real lacquer matt)

Smoothly painted doors with a flawless finish elevate your home to something truly exceptional: for a personalized touch, you can customize your Hörmann residential interior door with a brilliant colour effect in any RAL shade of your choice. Or you can enhance your doors with an elegant matte surface finish in our preferred lacquered colours for a sophisticated and stylish ambience. All lacquers give both the door leaf and the frame a smooth uniform coating with a seamless edge transition. So you can enjoy a radiant, rejuvenated ambience.

Real lacquer

- 1 Traffic white RAL 9016
- 2 Pure white RAL 9010
- 3 Light grey RAL 7035
- 4 Taupe RAL 7048
- 5 Dusty grey RAL 7037
- 6 Anthracite grey RAL 7016
- 7 Jet black RAL 9005

Real lacquer matt

- 8 Traffic white RAL 9016
- 9 Pure white RAL 9010
- 10 Light grey RAL 7035
- 11 Taupe RAL 7048
- 12 Dusty grey RAL 7037
- 13 Anthracite grey RAL 7016
- 14 Jet black RAL 9005

The colours shown are subject to the limitations of the printing process and cannot be regarded as binding. All RAL colours based on RAL colour chart. **Please consult with your local Hörmann sales partner.**

Real wood veneer

Natural wood character

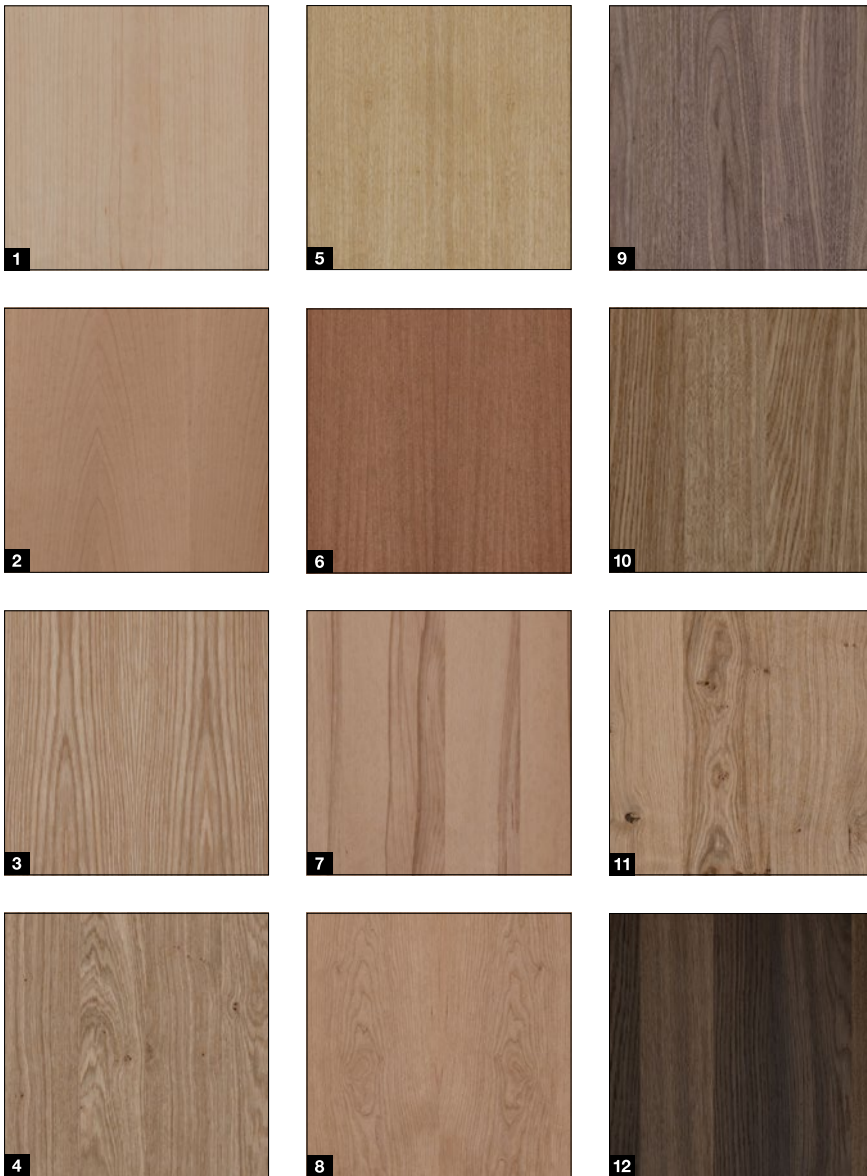

Natural, cosy, unique – Hörmann real wood veneers are produced from high-quality precious woods and are truly unique.

- 1** Canadian Maple matt*
- 2** Beech matt*
- 3** White Oak matt*
- 4** Knotty Oak matt*
- 5** Limba matt*
- 6** Sapeli matt*
- 7** Core Beech matt*
- 8** American Cherry Tree matt*
- 9** American Walnut matt*
- 10** European Oak planked matt*
- 11** Wild Oak matt*
- 12** Smoked Oak matt

The veneers shown are subject to the limitations of the printing process and cannot be regarded as binding. **Please consult with your local Hörmann sales partner.**

* also in veneer grain direction



Smoked Oak matt,
Listello

Core Beech matt,
Quirin Q1

Core Beech matt,
Quirin Q2

Core Beech matt,
Quirin Q3

Veneer variants

Listello

This real wood veneer and the stripe (measuring around 18 – 28 mm) creates an extremely elegant look.

Quirin

Combining horizontal with vertical veneer grain directions (Q1 – Q3) creates stylish door views.

Lever handle sets

For timber doors



Euro round lever handle Pro
Matt stainless steel

S P



Euro angular lever handle Pro
Matt stainless steel

S P



NEW. Euro lever handle Pro

- Modern Euro lever handle Pro in a round or angular version
- Minimalist door view without closing rose escutcheon
- Stress class 3 (construction door quality)
- Lever handle hole prepared at the factory for particularly fast and simple fitting as standard
- Available in a choice of stainless steel, Jet black RAL 9005 black.edition (see page 88) or brass (see page 91)

NEW. ProLock locking

1 Optional ProLock locking: integrated practically invisibly on the inside of the lever handle, for locking and unlocking the door from inside directly via the handle, in the toilet, bedroom or bathroom for instance, emergency opening on the opposite side possible

2 Optional ProLockPlus locking: lock on the outside of the lever handle, for locking and opening the door from outside with a key, the study for example, emergency opening on the opposite side possible



Linea
Polished stainless steel
F



Linea
Matt stainless steel
F



Basica 2
Matt stainless steel
S P



Karee
Matt stainless steel
S

Variants for lever handle and lock rose escutcheons

Lever handle and lock sets are a defining element for the overall appearance of your residential internal door. Hörmann offers different variants of the lever handle sets shown:

S STANDARD ROSE ESCUTCHEON. The approx. 10 mm-thick lever handle and lock rose escutcheons are surface-mounted on the door leaf.

F FLAT ROSE ESCUTCHEON. This flat rose escutcheon shape adds just 3 mm, resulting in an elegant door view.

P PLANAR ROSE ESCUTCHEON Perfectly inset in the door leaf, the fully flush-fitting Planar rose escutcheons are especially impressive for fans of design.

Another fine detail is the omission of the drilled key hole, allowing the design the look even more minimalistic and therefore more elegant.



S



F



P

Door fittings

For rebated timber doors

 Rebated with rounded edges

 Rebated with angular edges

→ Further information can be found on page 100.



Deadlock, Class I, lock cover in nickel silver (as standard)



2-part hinge V 3420 WF (as standard)



3-part hinge V 4426 WF (optional)



3-way adjustable hinge VX 160 - 18 (optional)



Concealed hinge Pivota FX 2 60 3D (optional)



NEW. STV Inclino 3D hinge for steel frames

Door fittings

For flush-closing timber doors

Flush

→ Further information can be found on page 100.



Deadlock, Class I, lock cover in nickel silver (as standard)



Magnetic catch lock to gently and quietly close the door (optional)



NEW. Magnet catch lock with particularly short lock cover for an even more discreet door view (optional)



Euro hinge concealed 3-way AN (optional)



Concealed 3-way adjustable hinge DX 61 (optional)



NEW. STV Inclino 3D hinge for steel frames

Door fittings black.edition

In elegant Jet black

For design lovers, we recommend the door fittings in elegant Jet black. In contrast with white or grey surface finishes, our **black.edition** gives your door an exclusive touch.

Only from Hörmann

All door fittings in
black.edition

4Protect contrasting edge

→ Further information can be found on page 101.

Frame seal

Door hinges

Lever handle set

Lock plate and lock cover



Lever handle sets for timber doors



NEW. Euro lever handle Pro round black.edition
Jet black matt

S P



NEW. Euro lever handle Pro angular black.edition
Jet black matt

S P

The Euro lever handle Pro round / angular is also available with the optional ProLock / ProLockPlus locking (see page 84)



Karee black.edition
Jet black matt

S F

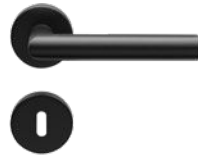

Linea black.edition
Jet black matt

S F P

S Standard rose escutcheon

F Flat rose escutcheon

P Planar rose escutcheon

For further information, see page 85.



Magnetic catch lock black.edition to gently and quietly close the door (optional)



NEW. Magnet catch lock black.edition with exceptionally short lock cover for an even more discreet door view (optional)



Euro hinge concealed 3-way AN black.edition in Jet black (optional)



Concealed 3-way adjustable hinge DX 61 in Jet black (optional)



3-part hinge V 4426 WF black.edition in Jet black (optional)



2-part hinge V 3420 WF black.edition in Jet black (optional)



Sliding door fitting Slide Compact black.edition

Door fittings black.edition

In elegant Jet black

Door fittings and lever handle sets for glass doors



Purista Combi fitting set, black.edition
Matt Jet black incl. magnetic catch lock



Linea black.edition
Jet black matt



Karee black.edition
Jet black matt



Agita black.edition
Jet black, with pneumatic
closing function, maximum
door leaf weight 60 kg



Agita Ultra black.edition
Jet black, with hydraulic
closing function and
adjustable closing speed,
max. door leaf weight
100 kg

Recessed handles and bar handles for sliding doors



Bar handle pair Basic
round black.edition
in Jet black

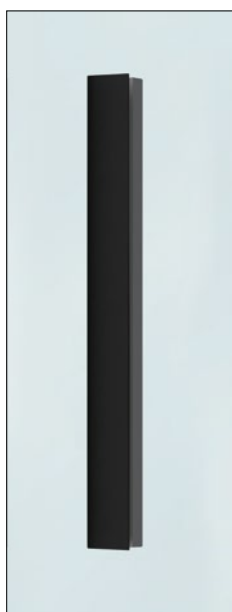

Flat handle black.edition
in Jet black



Recessed handle
Rondell 3659 round
black.edition
in Jet black



Recessed handle
Norma 3657 oval
black.edition
in Jet black



Recessed handle 6403
(only for glass doors)
angular black.edition
in Jet black



Design recessed handle
3648 (only for timber
doors) angular
black.edition
in Jet black

NEW. Brass door fittings

Lever handle sets, hinges and lock plates

Door fittings for flush-closing door leaves



NEW. Magnet catch lock brass with exceptionally short lock cover for an even more discreet door view (optional)

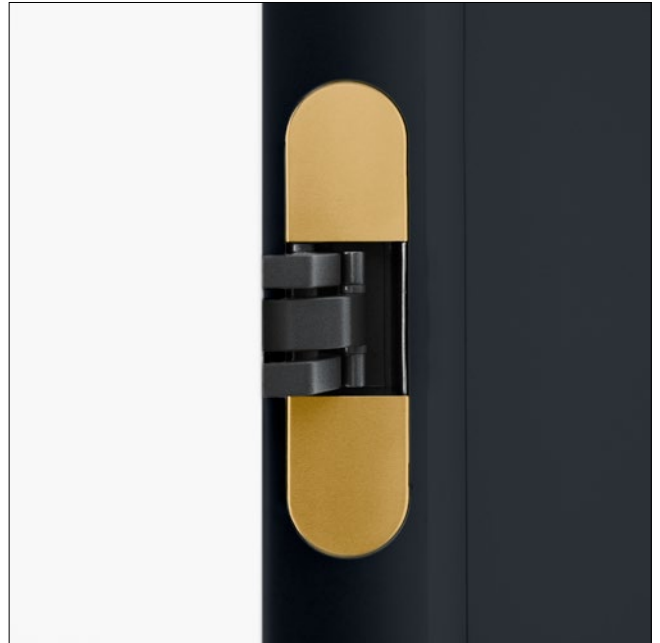

NEW. Euro hinge concealed 3-way AN brass (optional)



NEW. Euro round lever handle Pro

Brass

S **P**

S Standard rose escutcheon

P Planar rose escutcheon

For further information, see page 85.

Lever handle sets and door fittings

For glass doors



Linea
Matt stainless steel,
polished stainless steel or EV1



Basica 3
Matt stainless steel or EV1



Aronda Combi fitting set
Matt stainless steel,
polished stainless steel or EV1



Purista Combi fitting set
Matt stainless steel,
polished stainless steel or EV1



Conica Combi fitting set
Matt stainless steel or EV1



Mina Combi fitting set
Matt stainless steel, special glass
door version required



Puristo S fitting set
Cashmere grey (shown) or stainless
steel, optionally with Smart2Lock
for locking the door at the handle

Smart2Lock locking

The locking mechanism is elegantly integrated into the door fitting and can be locked and unlocked with one hand. When locked, the lever handle can no longer be pressed down from outside or inside. Thanks to this intelligent locking technology, glass doors can be locked without a key.



Leaf Light
Cashmere grey (shown)
or stainless steel



Remote
Cashmere grey (shown)
or stainless steel

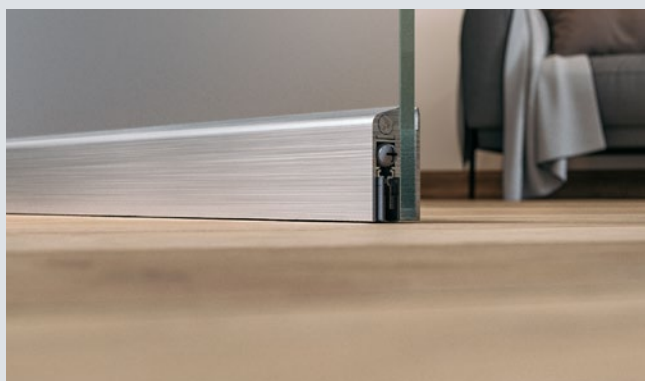

Increased acoustic insulation

Do you want quiet, bright living spaces and workspaces? Then we recommend the optional equipment for revolving glass doors Clear and satin-finished glass with 11 mm laminated safety glass and retractable bottom seal. Look forward to doors with an acoustic insulation value of up to 32 dB (corresponding to acoustic rating category SK 1).

Double-action door hinges

For glass doors



Double-action door hinges

Double-action door hinges are also available as options for all glass doors. This allows the door to be opened from both sides – a highly practical option in areas where space is at a premium. The double-action door hinges can be fitted in the passage frame or directly on the brickwork.



Agita

Matt stainless steel, with pneumatic closing function, maximum door leaf weight 60 kg



Agita.Ultra

Matt stainless steel, with hydraulic closing function and adjustable closing speed, maximum door leaf weight 100 kg

Door fittings and handles

For sliding doors

Slide Compact sliding door system



The profile of the sliding door system Slide Compact is supplied as standard in matt stainless steel (shown, left) and optionally in matt Jet black (shown, centre) or White (shown, right).

Sliding door system Slide Compact with additional vertical stop (stainless steel colour) for single-leaf doors, running in front of the wall

Sliding door system in the frame



With the brush seal on the door leaf (shown on left) and the inlet seal in the frame (shown on right), the sliding doors with frame type C running in front of the wall offer optimum protection against odours, noise and draughts – for even greater comfort in your home.

For sliding doors running within the wall, you can use a trip handle to release a door leaf completely concealed in the wall and close the door at the push of a button.

Recessed handle for timber and glass doors



Recessed handle 6402 only for timber doors, round, matt stainless steel



Recessed handle 6403 only for glass doors, angular, stainless steel colour



Design recessed handle 3649 only for timber doors, oval, matt stainless steel



Recessed handle FSB 4212, oval, matt stainless steel or aluminium



Recessed lever handle FSB 4251, angular, fastenings for pushing in, matt stainless steel



Recessed handle FSB 4250, fastenings for pushing in, only for timber doors, matt stainless steel



Recessed lever handle FSB 4252, round, fastenings for pushing in, matt stainless steel

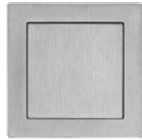

Recessed handle FSB 4253, square, fastenings for pushing in, matt stainless steel



Recessed lever handle Norma 3657, oval, matt stainless steel



Recessed handle Rondell 3659, round, matt nickel

Bar handles for timber and glass doors



Bar handle pair Basic, round, matt stainless steel

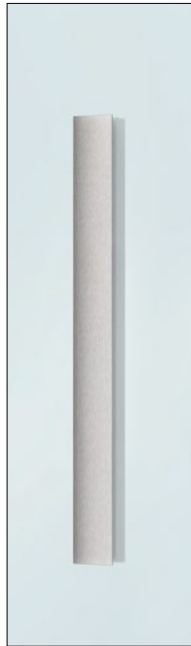

Flat handle, matt stainless steel

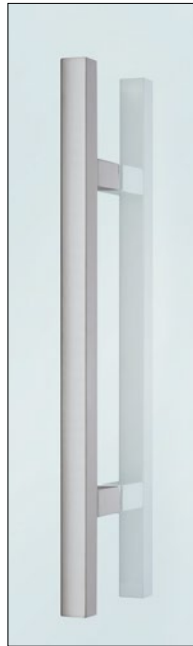

Bar handle pair Basic, angular, matt stainless steel



Bar handle pair U-grip, round, matt stainless steel

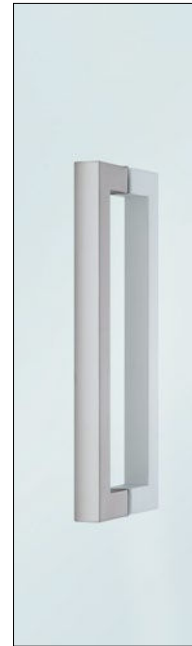

Bar handle pair U-grip, angular, matt stainless steel

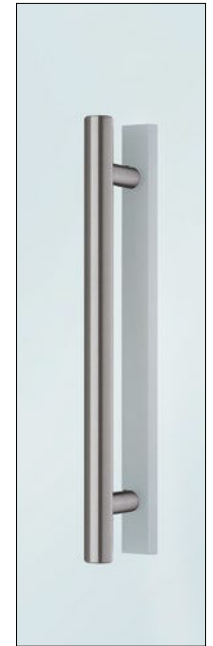

Bar handle combination Combi, flat handle

Glazing cut-outs, side elements, transom lights

For timber doors

Glazing cut-outs for timber doors ProLine



DIN LA 5 LA 9 LA 10



LA 11 LA 24 centre LA 27 LA Pure

Profile strips



Profile 0: Standard profile for hinged doors



Profile 26: Rail frame profile



Profile 28: Standard profile for sliding doors



Profile 46: Flush-fitting profile

Side elements (intel-high)



Single-leaf, 1 side element Single-leaf, 2 side elements

Transom lights (ceiling-high)



Single-leaf, 1 top part, alternatively also with transom light Double-leaf, 1 transom light

Glazings for glazing cut-outs

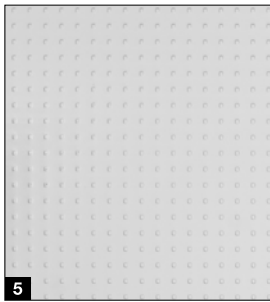
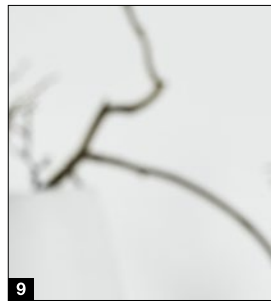
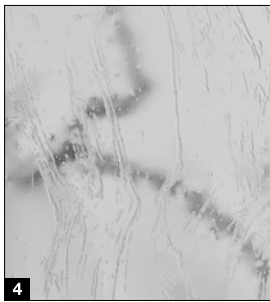
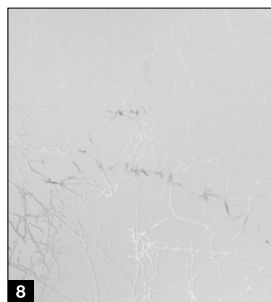
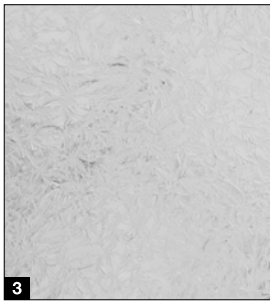
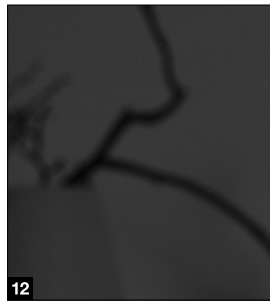
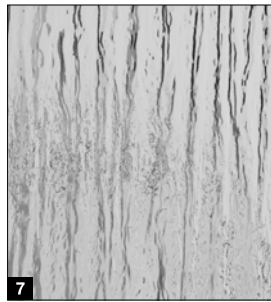
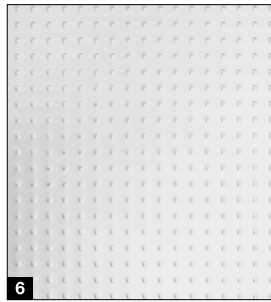
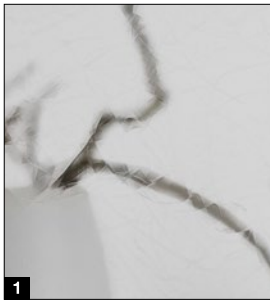

Glass types

- 1** Artista clear
- 2** Chinchilla white
- 3** Frost flower glass white
- 4** Gothic white
- 5** Pave white
- 6** Master-Carré
- 7** Silvit 178 white
- 8** Uadi white
- 9** Clear laminated safety glass
- 10** Clear white laminated safety glass
- 11** Clear grey
- 12** Dark grey
- 13** Clear bronze
- 14** GrooveGlass 15 / 10, clear style
- 15** GrooveGlass 15 / 10 matt style

Door and frame design*

Premium carpenter quality for high demands



Attractive appearance with precision-fit and installation-friendly corner joints ¹

Jamb lining

- Screwed corner joints with jamb lining connection
- Easily readjustable
- Strong friction locking

Cladding

- Solid-metal screw connectors
- Excellent friction locking
- Direct pressure distribution on the connection surfaces
- No visible drilled holes in the cladding

High form stability thanks to the robust frame construction ²

- Jamb lining 25 mm thick
- Jamb lining with Duradecor surface finish
- Melamine-coated backing
- Claddings made of MDF

A Edge radius 3 mm

B Wall edges

16 mm

23 mm (optional)

C Cladding widths

60 mm

70 mm (optional in Duradecor White lacquer)

80 mm

* in ProLine, DesignLine, ClassicLine and GlassLine versions

Permanently quiet closing thanks to a high-quality seal ³

- Two-chamber system
- Clean contact with the door leaf
- Good absorbing properties
- **NEW.** Opaque

Robust standard lock plate for added security ⁴

- Movable backfill
- Secured with 6 screws
- Double-turn closing cycle
- Retrofit kits available

Hybrid hinge pocket prevents lowering of the door ⁵

- Carrying capacity 80 kg
- Reinforced metal plastic mount
- Secured in jamb lining with 4 screws
- Guiding sleeves extending to front edge of cladding
- For timber and glass doors

High stability thanks to door leaf with frame construction ⁶

- Internal doors with 70 mm frame construction
- On hinge side and lock side

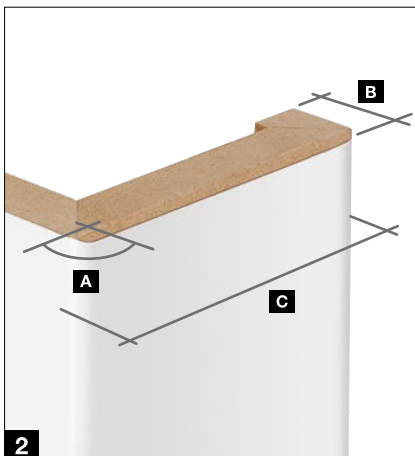
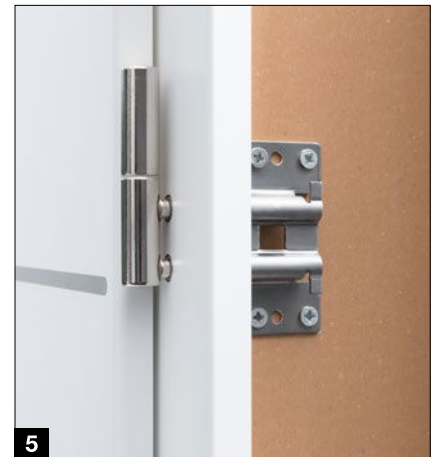

Door and frame types

Custom design and function



Rebated version with round edges

If you value a harmonious overall design, you can't go wrong with this version: The door leaf rests on the frame and has rounded door leaf edges for a harmonious appearance. The rebated door view with round edges is available for all timber doors, except DesignLine Stripe 15 and ClassicLine Montana.

Rebated version with angular edges

If you appreciate a particularly streamlined look, then we recommend this version. The door leaf rests on the frame and has a beautifully designed, angular edge. It is available for all timber doors except for ClassicLine Carolina. In the Duradecor surface finishes with 4Protect edge guard and in the lacquer surface finish, this version boasts a perfectly seamless look.

Flush version

Are you looking for an exclusive door view in your home, with a virtually flush-fitting transition to the frame? Then we recommend a flush-closing door leaf, which harmonises particularly well with modern interior design concepts. This version is available for all timber doors with the exception of ClassicLine Carolina. In the Duradecor surface finishes with 4Protect edge guard and in the real lacquer surface finish, this version impresses with a perfect seamless look.



4Protect edge guard



4Protect edge guard

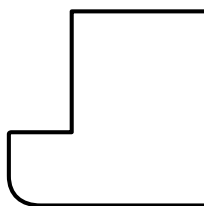

Horizontal view of door leaf

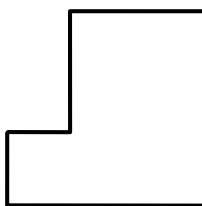

Horizontal view of door leaf

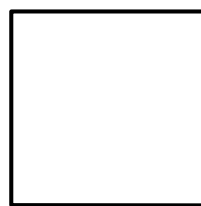

Horizontal view of door leaf



4Protect edge guard

The quadruple edge guard offers impressive features:

1. High impact resistance
2. High wear resistance
3. High scratch resistance
4. Seamless look, meaning that unlike conventional doors, no unsightly edge disrupts the high-quality door view.



Rebated version with angular edges



Flush version

Contrasting edge 4Protect

The 4Protect contrasting edge in 6 colours gives timber doors with the Duradecor surface a special finishing touch.



Black



Anthracite



Dusty grey



White



Light grey



Taupe

Door and frame types

Custom design and function

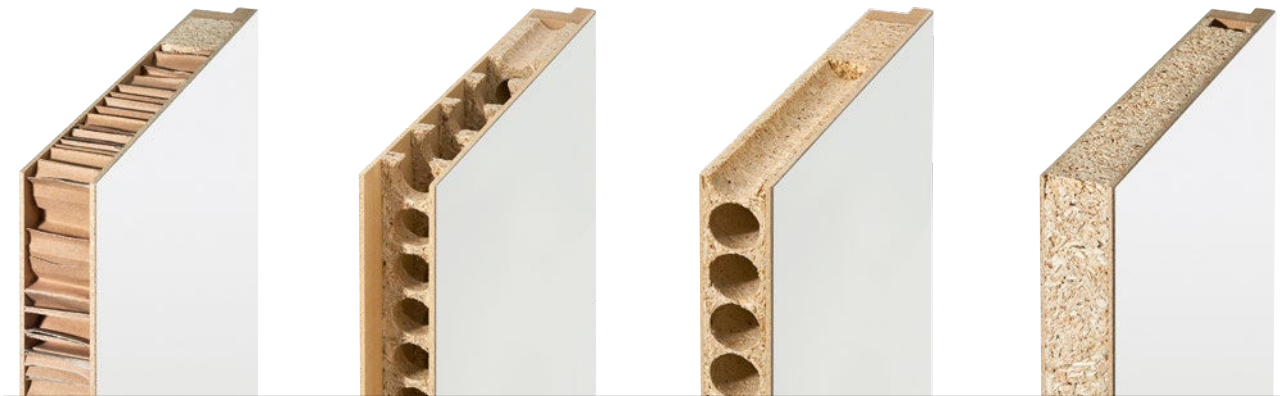

Honeycomb insert

The honeycomb is a door inlay that retains its shape and has an excellent price-performance ratio.

Tubular chipboard spacers

The door inlay consists of individual spacers that are arranged in the best possible layout. This means the door leaf is especially sturdy and suitable for heavy wear.

Tubular chipboard plate

The solid plate with horizontal tubes gives the door leaves a high surface stability. These high-quality residential internal doors are suitable for even extremely heavy wear.

Solid chipboard

The high-quality solid chipboard door leaves have the highest leaf rigidity and are suitable for particularly heavy wear. Doors with glazing cut-outs are available with solid chipboard as standard.



Profile frame

With rounded edges

Profile frame

With angular edges (only for lacquer surface)

Profile frame

With profiling for ClassicLine Georgia and Carolina

Block frame

For fitting in the opening or **fascia frame** for fitting in front of the wall



90° door frame

If you appreciate a highly linear door view, we recommend our 90° door frame. Unlike a frame with a mitre cut, the frame cladding used in this case has vertical edges. This results in a particularly harmonious look when combined with classic door styles.

VarioFix steel frame

The perfect combination of design, robustness and a long service life

High-quality design

For the steel frame VarioFix, the corner joints feature high-quality welding and a flush polish, meaning there are no visible mitre cuts in the frame corners. In flush-closing doors, the robust construction guarantees a uniform gap dimension, as the door frame can no longer warp after fitting.

Ideal combination

The steel frame harmonises perfectly with other timber frames due to a frame face of 55 mm on both sides. To match our door leaves in Duradecor White lacquer and real lacquer Traffic white, the VarioFix frame is available in Traffic white RAL 9016 with a white sealing profile or in RAL to choose. The frame can be combined with glass or timber door leaves.

Particularly long-lasting

Thanks to the high-quality powder coating, the frame can withstand run-ins with toy cars or vacuum cleaners, and any damage to the surface is easy to repair. Even cleaning water and a thorough washing cannot damage the door frame.

Fast fitting

The VarioFix steel frame can be fitted to all wall types without screw fitting, using 2C foam, like a timber frame. This results in time savings of up to 50% during fitting compared with standard steel frames. Wall tolerances of up to 20 mm are no problem for the steel frame VarioFix. The adjustable decorative rebate easily compensates for different wall thicknesses during renovations and new construction projects.



Zeroline frame

Clean design for modern living space concepts

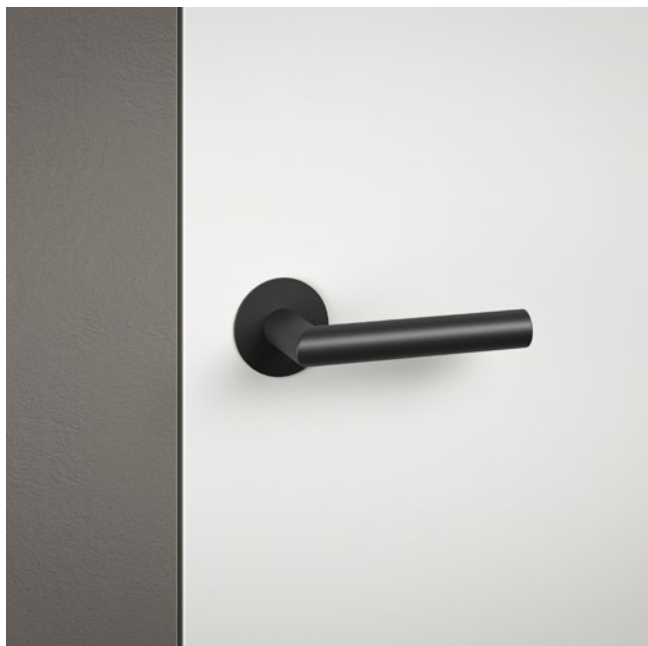

The beauty of the invisible

If you value clear design language and appreciate clean, modern design, then the Zeroline frame is the perfect choice. The minimalist appearance impresses with a flush-fitting door leaf, virtually invisible frame construction owing to a frame face of just 2 mm, plus concealed hinges. This door leaf / frame combination is a perfect fit for ambitious designs.

Frame with fabric as standard

The frame is equipped as standard with a woven fabric tape which is applied to the plaster to prevent crack formation. This completely integrates the frame into the wall.

Flush-fitting skirting boards

Skirting boards to match the frame and onto which the plaster can be directly applied are available. Skirting boards can therefore be integrated flush into the wall.

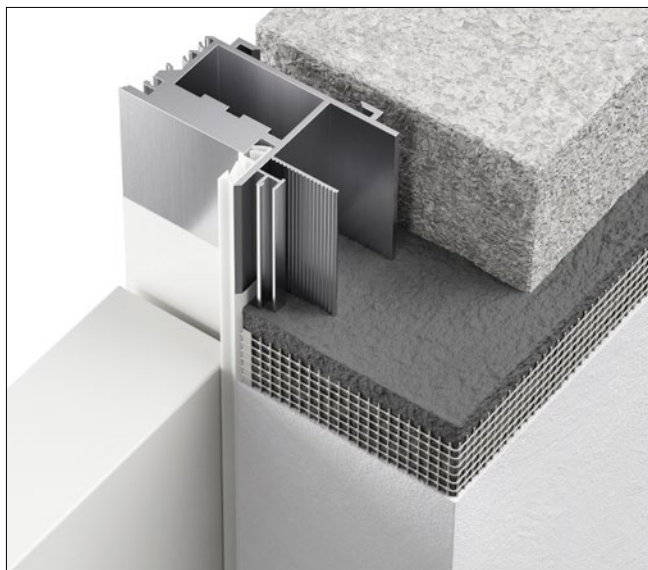

Additional use of a flexible woven fabric prevents cracks from forming in the plaster.

Equipment features

- Flush-closing door leaf
- 40 mm door leaf thickness
- Concealed hinges
- Magnetic catch lock

Colours / surface finishes

- Traffic white RAL 9016
- Jet black RAL 9005
- Anodised aluminium

Nominal sizes

Max. height: 2250 mm

Max. width: 1250 mm

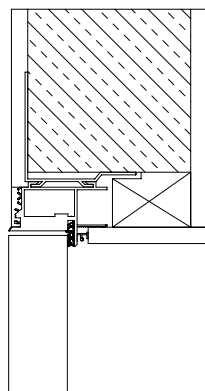

Horizontal sectional view with flush-closing door

Reverse timber door

The door has an almost flush-fitting view on the hallway side

Opens through the frame into the next room

If you require a matching, almost flush-fitting door view on the hallway side and the doors need to open through the frame into the room beyond – and not into the hallway as usual – then we recommend our reverse-opening doors (as shown, bottom right).

Elegant appearance

Concealed hinges emphasise the minimalist, modern door view.

Easy to combine

Thanks to the identical appearance of the door leaf and frame with an almost flush-fitting transition, reverse-opening doors can be readily combined with flush-closing doors in the same room or hallway. This results in a harmonious and welcoming overall ambience.

Equipment features

- Flush-closing door leaf with reveal rebate
- 40 mm door leaf thickness
- Concealed hinges
- Magnetic catch lock
- Opening limiter

Nominal sizes

Max. height: 2489 mm

Max. width: 1174 mm

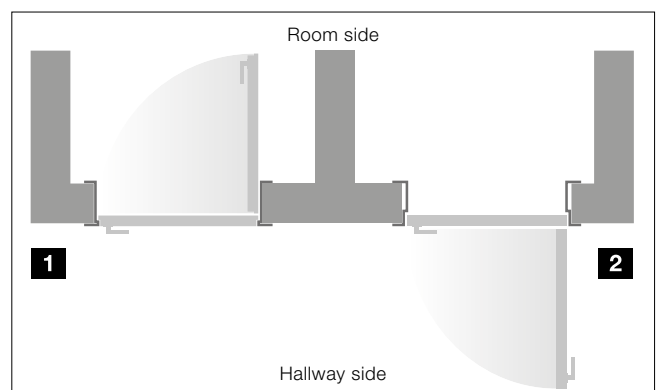







The reverse-opening door (left-hand hinge) opens into the room **1** and the normally opening flush-closing door (right-hand hinge) opens into the hallway **2**.

Function and construction project doors











For more security and convenience

Climate and apartment entrance doors

	WET system 1 ¹⁾	WET system 2*	WET system 3*
Door thickness approx.	40 mm	46 mm	52 mm
Max. dimensions	2110 × 985 mm	2235 × 1110 mm	2485 × 1235 mm ²⁾
Linkage door closer	○	○	○
Slide rail door closer	○	○	○
VarioFix frame	○	○	○
 Climatic class 3	●	●	●
 Acoustic rating category 1	●	-	-
 Acoustic rating category 2	-	●	-
 Acoustic rating category 3	-	●	●
 RC2 security features	-	○	○
 RC3 security features	-	-	●

● = Standard equipment ○ = Optional equipment

Fire-rated doors / smoke-tight doors

	Smoke-tight door ³⁾	T30 / EI ₂ 30 fire-rated door ⁴⁾	T30 garage connecting door	T90 / EI ₂ 90 fire-rated door ⁵⁾
Door thickness approx.	46 mm	50 mm	70 mm	70 mm
Max. dimensions	2235 × 1110 mm	2235 × 1235 mm	2235 × 1235 mm	2485 × 1235 mm
Linkage door closer	○	●	○	●
Slide rail door closer	●	○	●	○
 T30 / EI ₂ 30 Fire-retarding	-	●	●	-
 T90 / EI ₂ 90 Fire-proof	-	-	-	●
 Smoke protection	●	○	●	○
 Climatic class 2	-	●	-	●
 Climatic class 3	○	○	●	○
 Acoustic rating category 1	○	○	●	○
 Acoustic rating category 2	●	○	○	○
 Acoustic rating category 3	○	○	○	-
 RC2 security features	○	○	●	○
 RC3 security features	-	-	○	○

● = Standard equipment ○ = Optional equipment

¹⁾ only ProLine

²⁾ With RC3: 2235 × 1110 mm

³⁾ Only ProLine, other door versions on request

⁴⁾ Only for ProLine, Groove, Line, Plain and ClassicLine Kontura

⁵⁾ Only for ProLine Duradecor



Spyhole 1

With an optional spyhole, you can see who is standing in front of your door at any time without having to open it.

Electric strike 2

With the optional electric strike catch, you can conveniently open your door via a switch inside the home.

Lock equipment 3

Option of self-locking automatic lock or automatic door opener

Protective fitting 4

Option of long escutcheon / rose escutcheon ES 1 or long escutcheon / long escutcheon ES 2

Linkage door closer 5

As standard or optional for single-leaf doors (depending on design)

Slide rail door closer 6

As standard or optional for single-leaf and double-leaf doors (depending on design)

Fire protection lever 7

(Profile cylinder not included in the scope of delivery) As standard in black plastic, or optionally as a stainless steel lever handle.

Door lock operator SmartKey 8

Available in white or silver, incl. hand transmitter HSE 4 SK BS with labelled buttons

Dimensions and technical manual

For timber doors

Door leaf

- Approx. 40 mm or 45 mm thick (for doors with real wood veneer)
- Frame construction made of solid timber / timber material with additional frame reinforcement, can be shortened by 25 mm at bottom
- For double-leaf doors: with counter rebate ¹⁾
- Climatic class 1
- Duty category N to S (depending on version)
- Ready to hang acc. to DIN 18101
- Suitable for timber profile frames or standard frames made of steel

Frame

- Wall thickness adjustable – 5 mm / + 15 mm or – 5 / + 10 mm (for doors with real wood veneer)
- Seal inserted at the factory, chamfered

Frame dimensions

- A** Edge radius 3 mm
- B** Wall edges
 - 16 mm
 - 23 mm
- C** Cladding widths
 - 60 mm
 - 70 mm ²⁾
 - 80 mm
 - 100 mm
- D** Jamb lining
 - 25 mm thick

Vertical view

Rebated

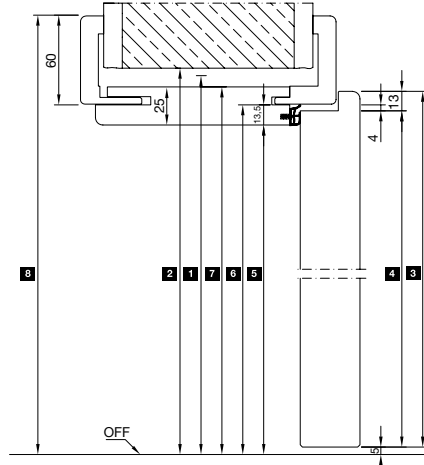

Flush

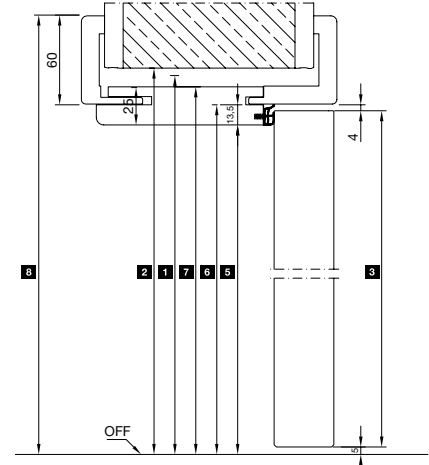

		1875	2000	2125	2250
1	Nominal height				
2	Wall opening	1880	2005	2130	2255
3	Door leaf exterior dimension	Rebated	1860	1985	2110
		Flush	1847	1972	2097
4	Leaf rebate dimension	1847	1972	2097	2222
5	Clear passage dimension	1843	1968	2093	2218
6	Frame hold dimension	1856	1981	2106	2231
7	Overall lining dimension	1868	1993	2118	2243
8	Overall frame dimension For 60 mm cladding (for 80 mm cladding +20 mm)	1916	2041	2166	2291

Frame types

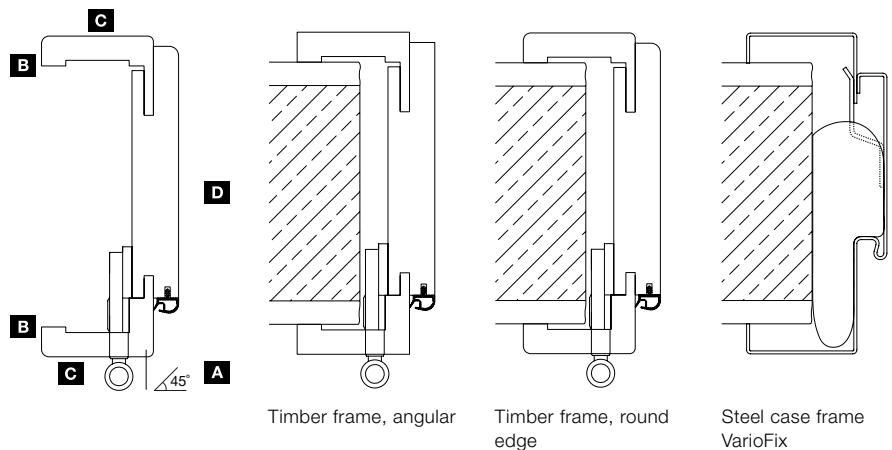

¹⁾ For Carolina styles with meeting style

²⁾ Only available with 23 mm wall edge

³⁾ Only for Carolina door styles

Dimensions in mm

Horizontal view – single-leaf

Rebated

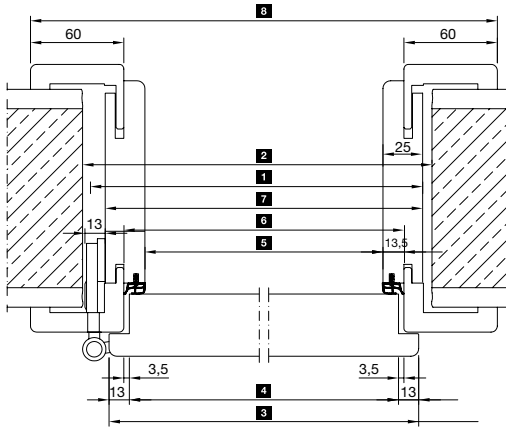

Flush

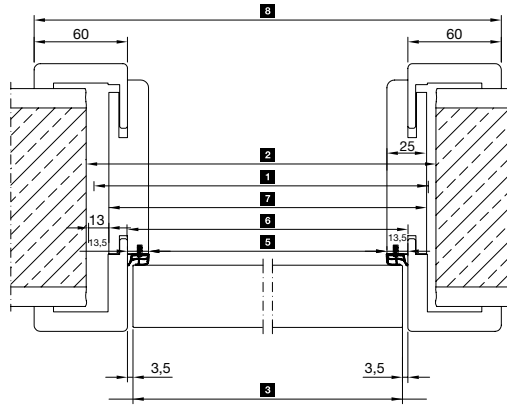

1	Nominal size width		625	750	875	1000	1125	1250
2	Wall opening		635	760	885	1010	1135	1260
3	Door leaf exterior dimension	Rebated	610	735	860	985	1110	1235
		Flush	584	709	834	959	1084	1209
4	Leaf rebate dimension		584	709	834	959	1084	1209
5	Clear passage dimension		564	689	814	939	1064	1189
6	Frame hold dimension		591	716	841	966	1091	1216
7	Overall lining dimension		614	739	864	989	1114	1239
8	Overall frame dimension		711	836	961	1086	1211	1336

Horizontal view – double-leaf

Rebated

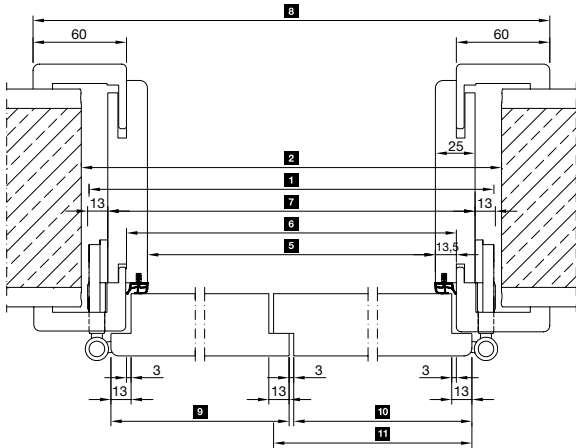

Flush

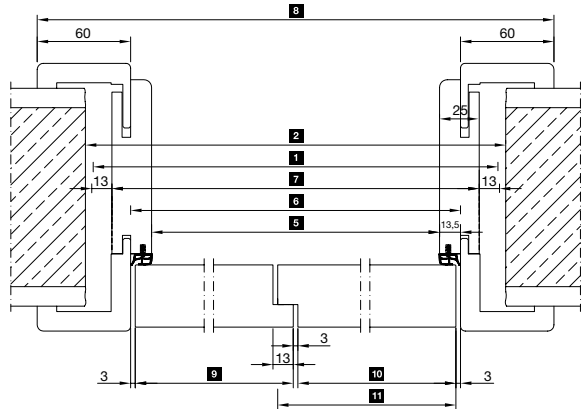

1	Nominal size width		1250	1375	1500	1750	1875	2000	2250	2500
2	Wall opening		1260	1385	1510	1760	1885	2010	2260	2510
5	Clear passage dimension		1176	1301	1426	1676	1801	1926	2176	2426
6	Frame hold dimension		1203	1328	1453	1703	1828	1953	2203	2453
7	Overall lining dimension		1226	1351	1476	1726	1851	1976	2226	2476
8	Overall frame dimension		1323	1448	1573	1823	1948	2073	2323	2573
9	Door leaf exterior dimension	Rebated	610	735	735	860	985	985	1110	1235
	Traffic leaf	Flush	597	722	722	847	972	972	1097	1222
10	Door leaf exterior dimension	Rebated	610	610	735	860	860	985	1110	1235
	Fixed leaf with meeting style ³⁾	Flush	597	597	722	847	847	972	1097	1222
11	Door leaf exterior dimension	Rebated	623	623	748	873	873	998	1123	1248
	Fixed leaf with counter rebate	Flush	610	610	735	860	860	985	1110	1235

Dimensions in mm

Dimensions and technical manual

Zeroline frame

Vertical view with flush door leaf

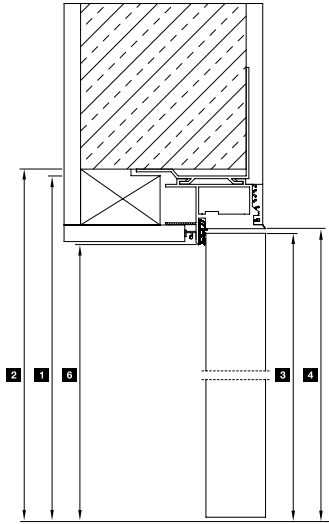

Horizontal view with flush door leaf

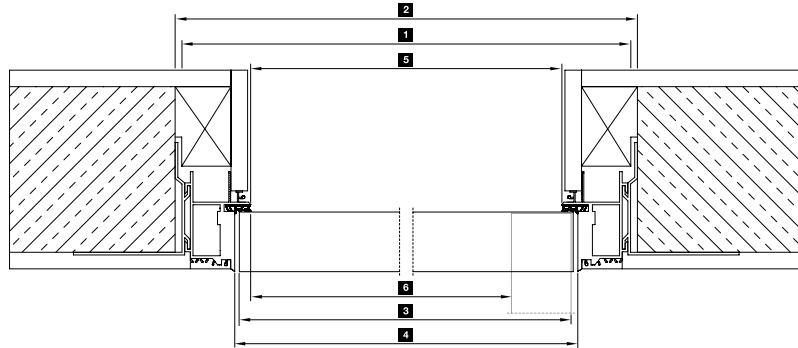

Vertical view with reverse-opening door leaf

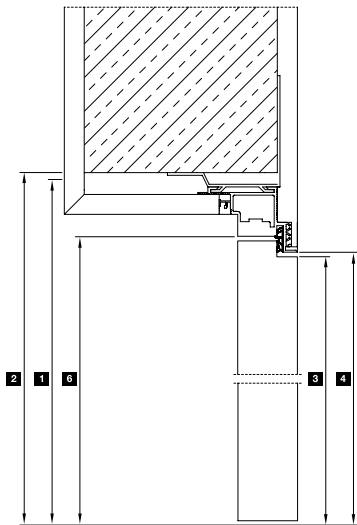

Horizontal view with reverse-opening door leaf

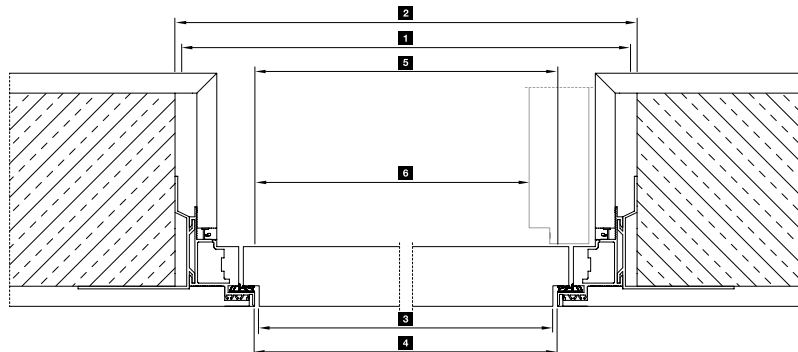

Zeroline frame dimensions

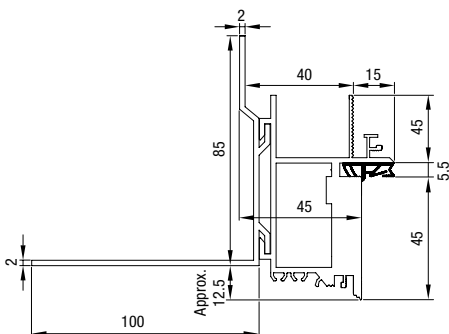

1	Nominal size width	750	875	1000	1125	921	1045
2	Wall opening	760	885	1010	1135	931	1055
3	Door leaf exterior dimension ¹⁾	663	788	913	1038	834	958
4	Frame hold dimension ¹⁾	670	795	920	1045	841	965
5	Clear frame dimension ¹⁾	646	771	896	1021	817	941
6	Clear passage dimension ¹⁾	610	735	860	985	781	905
1	Nominal height	2000	2125	2250	2026	2151	
2	Wall opening to FFL	2005	2130	2255	2031	2156	
3	Door leaf exterior dimension ²⁾	1949	2074	2199	1975	2100	
4	Frame hold dimension to FFL ²⁾	1960	2085	2210	1986	2111	
5	Clear passage dimension to FFL ²⁾	1948	2073	2198	1974	2099	

All dimensions for Zeroline frame with flush door leaf

¹⁾ For Zeroline frame with reverse-opening door leaf – 6 mm

²⁾ For Zeroline frame with reverse-opening door leaf – 3 mm

Vertical view

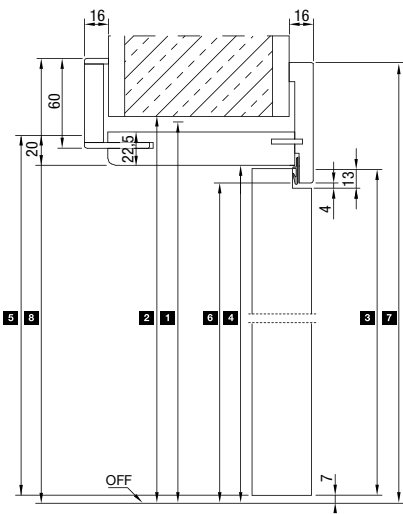

Horizontal views

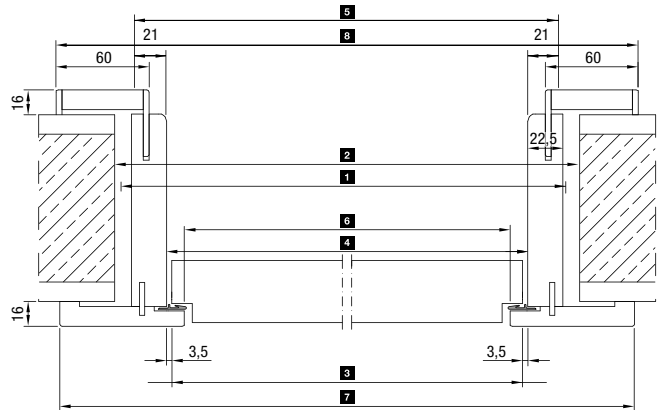

Closed

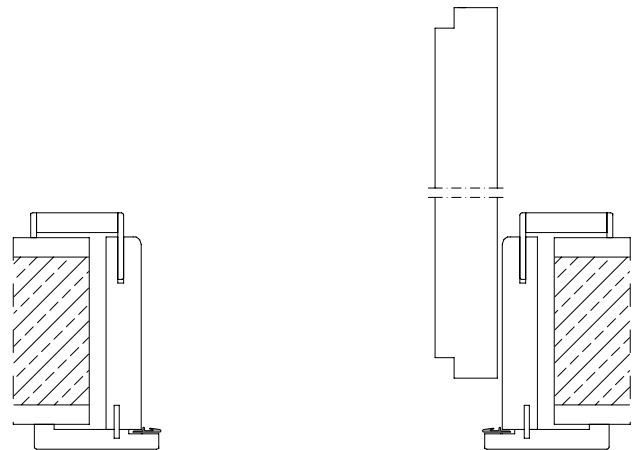

Open
(Left-hand hinged)

	Min.	750	875	1000	1125	Max.
1 Nominal size width	674	750	875	1000	1125	1174
2 Wall opening	684	760	885	1010	1135	1184
3 Door leaf exterior dimension	610	686	811	936	1061	1110
4 Frame hold dimension	617	693	818	943	1068	1117
5 Frame nominal dimension	659	735	860	985	1110	1159
6 Clear passage dimension	594	670	795	920	1045	1094
7 Overall frame dimension, visible side	754	830	955	1080	1205	1254
8 Overall frame dimension, opening side	760	836	961	1086	1211	1260
1 Nominal height	1875	2000	2125	2250	2489	
2 Wall opening to FFL	1880	2005	2130	2255	2494	
3 Door leaf exterior dimension	1835	1960	2085	2210	2449	
4 Frame hold dimension to FFL	1847	1972	2097	2222	2461	
5 Frame nominal dimension	1860	1985	2110	2235	2474	
6 Clear passage dimension to FFL	1836	1961	2086	2211	2450	
7 Overall frame dimension, visible side	1916	2041	2166	2291	2530	
8 Overall frame dimension, opening side	1919	2044	2169	2294	2533	
					Max.	

Dimensions in mm

Hörmann. For Life.

Whether you are building your home or modernising it, you desire a place full of joy, security and relaxation. Thanks to their sustainable and particularly durable quality, Hörmann products will become a reliable part of your home – made to last for generations.

GARAGE DOORS. GATE AND DOOR OPERATORS. SMART HOME SYSTEMS. ENTRANCE DOORS. RESIDENTIAL INTERNAL DOORS. LOFT DOORS. STEEL DOORS. DOOR FRAMES. STORAGE SPACE SYSTEMS.



Some of the products shown feature special equipment and do not always correspond to the standard versions. The surface finishes and colours shown are subject to the limitations of the printing process and cannot be regarded as binding. All RAL colours are based on the RAL colour chart. Protected by copyright. No part may be reproduced without our prior permission. Subject to changes.