



ALUMINIUM ENTRANCE DOORS

NEW. Design handle G 850 with individual design options for an exclusive door design



Save on paper and protect the environment:
Simply scan the QR code and download
the brochure online.

HÖRMANN



04



16



40

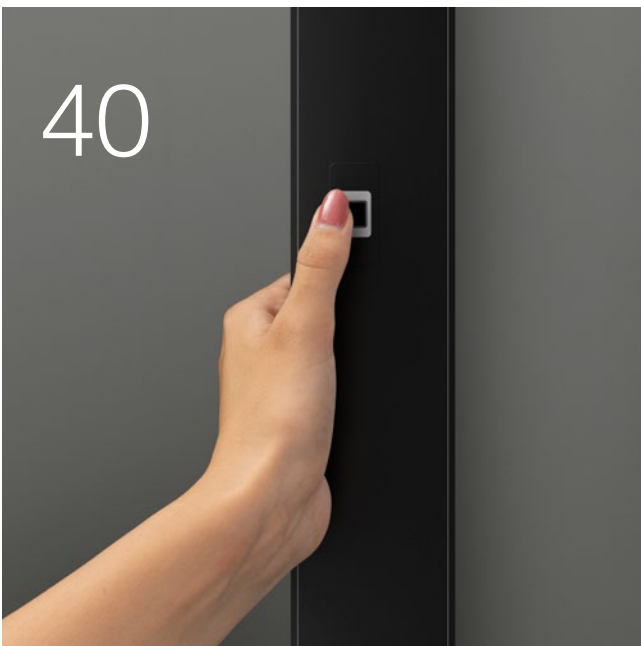

Content

- 04 **Good reasons to try Hörmann**

- 16 **Inspirations**
- 18 ThermoSafe
- 20 ThermoSafe Hybrid
- 26 ThermoPlan Hybrid
- 28 ThermoCarbon
- 30 TopComfort
- 31 TopComfort Portal
- 32 Letter box systems
- 34 Garage door and entrance door with a matching look
- 36 operating comfort
- 38 Barrier-free entrance areas

- 40 **Design, equipment, accessories**
- 40 Design overview
- 44 ThermoSafe / ThermoSafe Hybrid
- 62 ThermoPlan Hybrid
- 66 ThermoCarbon
- 70 TopComfort
- 72 TopComfort Portal
- 74 MatchColor, standard and preferred colours
- 76 Door leaf construction
- 78 Door versions
- 80 Door equipment
- 82 Security features
- 84 Security locks
- 88 Exterior handles
- 91 Lever handle sets
- 92 Glazing
- 94 Dimensions and technical manual

Responsibility for generations

The Hörmann family business has over 85 years of experience as a construction component specialist. This gives us an obligation to both current and future generations. That's why environmental responsibility plays such an important role for us. With this in mind, we develop innovative solutions for sustainable products and intelligent environmental protection.



“A GOOD REPUTATION MUST BE EARNED.”

August Hörmann

In keeping with the tradition started by the company's founder, the Hörmann brand is a true promise of quality and, with sales of over 20 million doors, door frames and operators, is one of Europe's most successful suppliers. Due to the comprehensive international sales and service network, Hörmann is your strong partner for high-quality construction components.



WE THINK AND ACT GREEN. As a family business, we are very conscious of our responsibility to future generations and offer all products for residential construction CO₂-neutral as standard. The Hörmann sustainability strategy aims to reduce and avoid emissions. We cover 100% of our electrical power needs at all European production sites with genuine green electricity from renewable sources. We also apply many other measures to reduce our consumption and save more than 75000 tonnes of CO₂ each year. We work with ClimatePartner to offset the remaining emissions by supporting certified climate protection projects.



You can find further information at
www.hoermann.com/sustainability



ClimatePartner
certified product
climate-id.com/XNEBKC



CO₂
measure
reduce
contribute

Brand quality made in Germany



The family-owned company Hörmann offers all important construction components for building and renovating projects from a single source. We manufacture in highly specialised factories using state-of-the-art production technologies. Our employees work intensively on new products, continual further developments and improvements to details. The results are patents and unique products on the market.





10-year warranty

LONG-LASTING. GUARANTEED. We produce our in-house entrance doors, designed for a long service life, with careful use of resources. Endurance tests under real conditions ensure mature series products with Hörmann quality. Thanks to this and uncompromising quality assurance, you receive a 10-year* warranty on all Hörmann aluminium entrance doors.

* The complete warranty conditions can be found at: www.hoermann.com



Acoustic insulation
Up to 39 dB

CONVINCING IN EVERY VERSION. Our aluminium entrance doors are superior to plastic or timber doors in many ways.



Excellent thermal insulation

Thanks to perfectly matched high-quality materials, we set benchmarks in terms of stability, acoustic insulation and thermal insulation. In addition, all of our aluminium entrance doors



Only from Hörmann

ThermoCarbon with a
U_D-value of up to 0.47 W/(m²·K)

meet the requirements of the German Buildings Energy Act (Gebäudeenergiegesetz, GEG). ThermoCarbon entrance doors are also certified for low-energy houses by ift Rosenheim.

→ Further information can be found starting on page 12.



Door leaf exterior made of stainless steel
ThermoSafe Hybrid
and ThermoPlan Hybrid

HYBRID CONSTRUCTION. ThermoSafe Hybrid and ThermoPlan Hybrid aluminium entrance doors feature a door leaf exterior made of stainless steel sheet and high-quality powder coating, especially impressive in south-facing fitting situations and with dark door colours. This design guarantees exceptionally high dimensional stability, even when there are large temperature differences between inside and outside, and also improved acoustic insulation.



NEW.
Flood-resistant entrance doors
ThermoSafe Hybrid
opening outwards

PROTECTION AGAINST FLOODING. Extreme rainfall can cause considerable damage. To minimise the impacts of flooding, it is advisable to use flood-resistant doors in residential buildings, along with other protective measures. Our ThermoSafe Hybrid aluminium entrance doors in the outward-opening version are now available in a flood-resistant version, tested in accordance with IFT guideline standard FE-07/2, effectively protecting entrances up to a water level of 500 mm.

Door design for the highest demands

Greet your guests with a Hörmann aluminium entrance door! And of course, you and your family can also delight in the sophisticated design of our doors day after day. Our doors are a true eye-catcher on the outside, and inside they harmonise perfectly with your residential internal doors. Simply beautiful!



DOOR LEAF WITHOUT VISIBLE LEAF PROFILE.

Our ThermoSafe, ThermoSafe Hybrid, ThermoPlan Hybrid and ThermoCarbon entrance doors give you an exquisite and elegant reception. The shapely door leaf with its solid interior and exterior and leaf profile on the inside fulfils the highest design requirements. The interior view harmonises perfectly with your residential internal doors.



Exterior and interior view of ThermoSafe entrance doors without visible leaf profile



Exterior and interior view of entrance doors from other manufacturers with visible leaf profile

CONCEALED HINGES.

The optional hinges are invisible from the outside, creating an elegant interior view without intrusive elements that is easy to clean.



We protect you from unwanted visitors

An apartment is broken into every five minutes, making it even more important to equip your entrance door with a high security standard. If a burglar is not successful within approx. 90 seconds, they generally give up their break-in attempt.

For this reason, nearly half of all break-in attempts fail if the entrance door is break-in-resistant.





Only from Hörmann



RC3 security
As standard*



Tested and certified

SECURITY EQUIPMENT AS STANDARD. Our entrance doors make it especially difficult for burglars to break into your home. This protects your home from break-in attempts. Without further optional extras, our entrance doors* achieve the highest possible classification of the security label (without burglar alarm system). And unlike many competitor solutions, the certified security features are not visible on the door.

→ Further information can be found starting on page 82.

Only from Hörmann



10-year security promise

10-YEAR SECURITY PROMISE. In the unlikely event of a break-in through one of our aluminium entrance doors with RC3 or RC4 security features, you will receive **a new Hörmann entrance door with the same features, including professional fitting by a Hörmann sales partner, or €3000 cash (for example if the damage is covered by your household insurance).**



Further information and a video on the topic can be found at www.hoermann.de/sicherheitsversprechen

The right door version for any requirement

You know exactly what you want for your new entrance door. From ThermoSafe to TopComfort Portal, Hörmann offers a wide variety of entrance doors from which you can choose one to suit you. This helps you find the door that perfectly meets your needs for thermal insulation, acoustic insulation and appearance.





ThermoSafe / ThermoSafe Hybrid

Exclusive class / extra class

- ✓ Very good thermal insulation and good acoustic insulation
- ✓ Flush-fitting interior
- ✓ Exterior made of stainless steel with high-quality powder coating (ThermoSafe Hybrid)



ThermoPlan Hybrid

Design class

- ✓ Very good thermal insulation and very good acoustic insulation
- ✓ Flush-fitting interior and exterior
- ✓ Door leaf exterior made of stainless steel with high-quality powder coating



ThermoCarbon

Premium class

- ✓ Excellent thermal insulation and good acoustic insulation
- ✓ Interior with thick rebate
- ✓ Up to 3000 mm door height



TopComfort

Extensive glazing

- ✓ Good thermal insulation and good acoustic insulation
- ✓ Individual glazings



TopComfort Portal

Double-leaf entrance door

- ✓ Good thermal insulation and good acoustic insulation
- ✓ Flush-fitting transition between the traffic leaf and the fixed leaf
- ✓ Flush-fitting interior and exterior

Choose the entrance door that matches your lifestyle

Your individuality decides. Whether you set most store by elegant door views, extensive glazing or intelligent door operation, you'll discover the door of your dreams with us. Be inspired by the Hörmann variety on the following pages or configure your new entrance door very conveniently online.





20% incentive possible

TAX INCENTIVES. that save you money.

In Germany, certain circumstances allow you to offset 20 per cent of your new entrance door purchase over three years.



Further information can be found at
www.deutschland-machts-effizient.de

THE DOOR OF YOUR CHOICE IN JUST A FEW CLICKS.

With the door configurator, you can conveniently test many design and product variants on your own PC or tablet in advance. You can put your dream entrance door together in just a few clicks by selecting the door version, style, colour and size. If you then upload a picture of your house and place the door in your entrance, you can see in advance how well your new entrance door will match your home.



The Hörmann configurator can be found at:
www.hormann.co.uk/home-owners-and-renovators/configurator







Inspirations

- 18 ThermoSafe / ThermoSafe Hybrid**
Exclusive class / extra class
- 26 ThermoPlan Hybrid**
Design class
- 28 ThermoCarbon**
Premium class
- 30 TopComfort**
Extensive glazing
- 31 TopComfort Portal**
Double-leaf entrance door
- 32** Letter box systems
- 34** Garage door and entrance door with
a matching look
- 36** Operating comfort
- 38** Barrier-free entrance areas

ThermoSafe

EXCLUSIVE CLASS. Our best-selling aluminium entrance door ThermoSafe meets the highest of design standards with a choice of over 70 styles. The flush-fitting transition from the door leaf to the door frame gives your doors an elegant interior look in perfect harmony with flush-closing residential internal doors.

→ Further information can be found starting on page 44.





PAGE 16 / 17. Aluminium entrance door ThermoSafe style 871, stainless steel handle
 HOE 620, Jet black RAL 9005 matt fine structure; L-ribbed sectional garage door, Silkgrain, Jet black RAL 9005 matt fine structure

LEFT. Aluminium entrance door ThermoSafe style 65, Grey aluminium RAL 9007 fine structure, stainless steel handle HOE 600

CENTRE. **NEW**. Design handle G 850, handle bar in Jet black RAL 9005 matt fine structure, handle application MatchDecor Rusty Patina

RIGHT. Aluminium entrance door ThermoSafe style 860, Jet black RAL 9005 matt fine structure, **NEW**. Design handle G 850, handle bar in Jet black RAL 9005 matt fine structure, handle application MatchDecor Rusty Patina



ThermoSafe Hybrid

EXTRA CLASS. Made of powder-coated stainless steel sheet with high-quality powder coating, the exterior of the ThermoSafe Hybrid door leaf guarantees particularly high dimensional stability, even in case of large temperature differences inside and outside, as well as improved acoustic insulation. In the outward-opening version, they are optionally available in a flood-resistant version, tested in accordance with IFT guideline FE-07/2, effectively protecting entrances up to a water level of 500 mm.

→ Further information can be found starting on page 44.





TOP LEFT. **NEW.** Aluminium entrance door ThermoSafe Hybrid style 137, stainless steel handle HOE 500, Quartz grey RAL 7039

BOTTOM LEFT. Stainless steel handle HOE 701

TOP RIGHT. **NEW.** Opening outwards ThermoSafe Hybrid aluminium entrance door as a flood-resistant door

BOTTOM RIGHT. Aluminium entrance door ThermoSafe Hybrid style 860
Stainless steel handle HOE 701, Anthracite grey RAL 7016



Door fittings black.edition

Do you love to see black in your home? Then our black.edition doors are the perfect choice for you. These doors feature exterior handles, applications and interior levers in elegant Jet black, subtly yet effectively embracing the latest design trend.

→ Further information can be found starting on page 88.





LEFT. Aluminium entrance door ThermoSafe 524 MatchDecor Barnwood, design handle G 750 in RAL 9005 Jet black matt fine structure, applications in RAL 9005 Jet black matt fine structure

TOP RIGHT. Aluminium entrance door ThermoSafe 524 MatchDecor Barnwood, design handle G 750 in Jet black RAL 9005 matt fine structure, applications in Jet black RAL 9005 matt fine structure, black glass glazing

BOTTOM RIGHT. Aluminium lever handle D-360 with round rose escutcheon, black.edition in Jet black RAL 9005, matt fine structure, inside Traffic white RAL 9016 matt





LEFT. Aluminium entrance door ThermoSafe style 421, Light grey RAL 7035 matt, stainless steel handle HOE 14-2

TOP RIGHT. Aluminium entrance door ThermoSafe style 422, Traffic white RAL 9016, stainless steel handle 14-2

BOTTOM RIGHT. Aluminium entrance door ThermoSafe style 891, Stone grey RAL 7030, stainless steel knob K 117





TOP. Aluminium entrance door ThermoPlan Hybrid style 860, stainless steel handle HOE 710, Hörmann colour CH 703-AM, Anthracite metallic matt fine structure, optional side element

RIGHT. Aluminium entrance door ThermoPlan Hybrid style 568, design handle G 750 anodised E6 / EV1, Anthracite grey RAL 7016 matt fine structure, optional side elements

ThermoPlan Hybrid

DESIGN CLASS. What's special about this door is its elegant, flush appearance. You see and feel hardly any offset on the inside and outside between the door leaf and door frame. The stainless steel sheet with high-quality powder coating on the outside guarantees particularly high dimensional stability, even in case of large temperature differences, allowing you to enjoy the flush-fitting appearance of your entrance door for the long-term. You also benefit from improved acoustic insulation of up to 33 dB.

→ Further information can be found starting on page 62.



LEFT. Aluminium entrance door ThermoCarbon style 308,
Anthracite grey RAL 7016 matt, handle bar White aluminium RAL 9006

CENTRE. Handle bar with recessed grip with style 308

RIGHT. Aluminium entrance door ThermoCarbon style 680,
Slate grey RAL 7015 matt

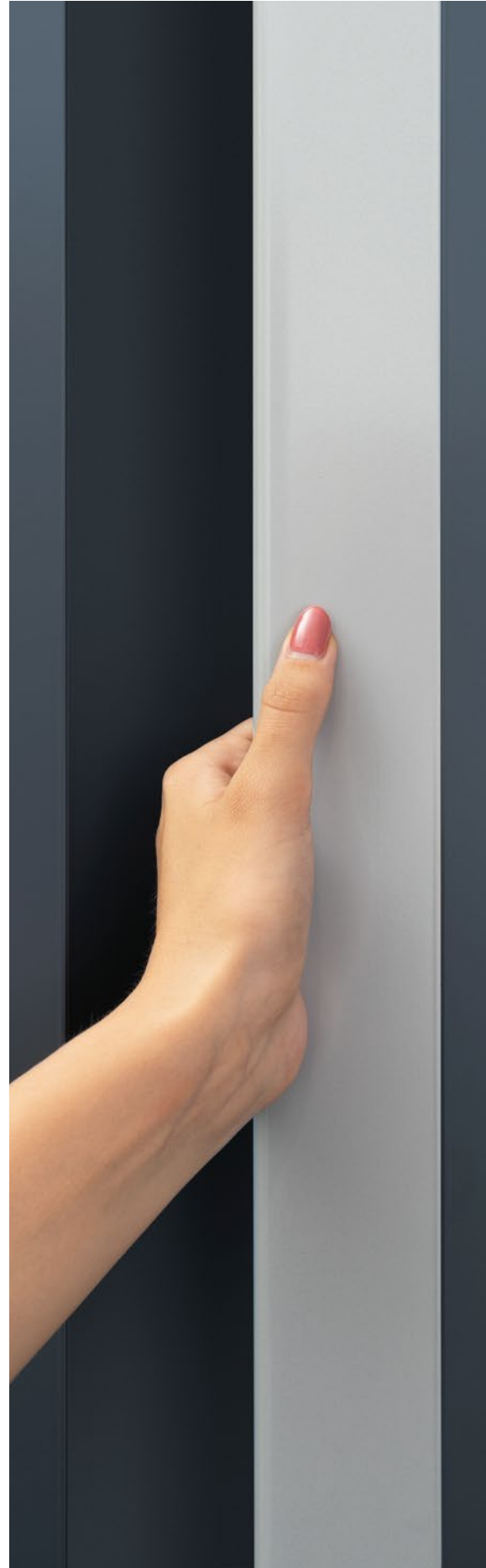



ThermoCarbon

PREMIUM CLASS. With the 100 mm thick high-tech leaf profile made of a carbon glass-fibre hybrid material, we can realise entrance doors with heights of up to 3000 mm. Thanks to the excellent thermal insulation, ThermoCarbon entrance doors are also certified for low-energy houses by ift Rosenheim. Highly effective break-in resistance equipment up to RC4 is also available. The many styles of flush-fitting lever handles meet the highest of design standards. With a subtle thick rebate, the inside of the door blends perfectly with your interior design.

→ Further information can be found starting on page 66.

TopComfort

ENTRANCES FILLED WITH LIGHT. Our TopComfort glass entrance doors create a bright and cheerful entrance area with solid equipment – for detached homes, blocks of flats or commercial entrances.

→ Further information can be found starting on page 70.





LEFT. Aluminium aluminium entrance door TopComfort style 100, Anthracite grey RAL 7016, design glass on request with house number in the side element

TOP. Double-leaf aluminium entrance door TopComfort Portal style 860, Anthracite grey RAL 7016, stainless steel handle HOE 710

TopComfort Portal

MORE CLEAR PASSAGE WIDTH FOR REPRESENTATIVE ENTRANCE PORTALS. Our double-leaf entrance door with aluminium frame construction impresses with a flush-fitting transition between the traffic leaf and the fixed leaf. You can choose between 7 door styles and door sizes up to 2600 mm wide and 2500 mm high.

→ Further information can be found starting on page 72.

Blocks of flats with letter box systems

Entrances to blocks of flats are used by many people and perform a number of important functions. Our TopComfort and ThermoSafe entrance doors feature safety glazing and meet the very highest standards in terms of accident and burglar protection. And the extensive glazing lets light flood in to create a bright atmosphere in the entrance area. Stylish letter box systems with an integrated light switch, intercom screen and bell button in the side elements make access easier for visitors.





LEFT. Aluminium entrance door TopComfort style 100, stainless steel handle HOE 710, Hörmann colour CH 703-AM Anthracite Metallic matt fine structure, optional side elements and integrated letter box system

TOP RIGHT. Integrated letter box systems mean residents can collect their post in the hallway without having to go outside.

BOTTOM RIGHT. Mail goes into the box from the outside, so there's no need to open the door for the postman.

Garage door and entrance door with a matching look

Want your entrance door and garage door in perfect harmony? Then combine your new entrance door with our perfectly matched sectional garage door styles. Our MatchColor colours and MatchDecor decors mean you can design your entrance door and sectional garage door with identical colours and decors.

→ Further information can be found starting on page 74.





TOP. Aluminium entrance door ThermoSafe style 173, stainless steel handle HOE 300, Quartz grey RAL 7039 matt, optional side elements; L-ribbed Silkgrain Quartz grey RAL 7039 matt sectional garage door with design style 461 glazing elements

BOTTOM LEFT. Aluminium entrance door ThermoSafe style 693, stainless steel lever handle CARO with round rose escutcheon, internal design Groove 15 matching residential internal door DesignLine Groove 15, lacquer Traffic white RAL 9016 matt

BOTTOM RIGHT. Aluminium entrance door ThermoSafe, style 860, door leaf in MatchDecor Barnwood, L-ribbed Duragrain Barnwood grey sectional garage door

Operating comfort for young and old

Open your entrance door easily and conveniently with our smart solutions. By code, fingerprint or smartphone. With our lock packages, you are sure to find an intelligent solution that meets your needs. With the Hörmann homee Smart Home control centre, you can conveniently control your Hörmann garage and entrance gate, as well as climatic sensors or a camera all with an app. At any time of day or night, from anywhere around the world.

→ Further information can be found starting on page 84.





TOP. Finger-scan elegantly integrated into the door leaf

BOTTOM LEFT. An electric strike allows the security lock H5 / H9 to be opened electrically, via the house intercom for example.

BOTTOM CENTRE. You can look through the electronic spyhole to see who is at your door.

BOTTOM RIGHT. Hörmann homee Home control centre for all areas of your home



Barrier-free entrance areas

DOOR OPERATOR HDO. Open and close your entrance doors fully automatically with the HDO 200 door operator. For barrier-free entrances like those in blocks of flats or retirement homes, we recommend combining the operator with a door featuring a trip-free threshold and retractable bottom seal. For your safety, the discreet flat sensor monitors the area of travel on the inside and outside of the door.





ELECTRIC OPENING AID ECTURN. Once the door is unlocked, press gently on the door leaf and your entrance door will open and close automatically. Thanks to low-energy operation, there are no dangerous crushing or impact situations. No additional safety equipment is required. The opening aid is integrated elegantly into the door leaf and frame or available as a surface-mounted version.

Tip

For easy door leaf locking, to carry objects through the door for example, we recommend an overhead door closer with mechanical hold-open device. For further information, see page 80.



CONVENIENT OPERATION. A combination with the S5 Smart or Bluetooth automatic locks allows you to unlock and open or close and lock your door at the same time. In the Smart version, very conveniently with Hörmann BiSecur hand transmitters or radio switches.



LEFT. Operators HDO 200 with safety sensor Flatscan for barrier-free accesses

TOP RIGHT. Ecturn opening aid in surface-mounted design

CENTRE RIGHT. Ecturn Inside opening aid as a concealed version

BOTTOM RIGHT. Simple door opening with hand transmitter in combination with the S5 / S7 Smart lock

Design overview

THERMOSAFE / THERMOSAFE HYBRID



Style 40
Page 51



Style 45
Page 45



Style 65
Page 45



Style 75
Page 48



Style 110
Page 49



Style 136
Page 49



NEW. Style 137
Page 45



Style 138
Page 49



Style 407
Page 55



Style 413
Page 54



Style 414
Page 54



Style 419
Page 55

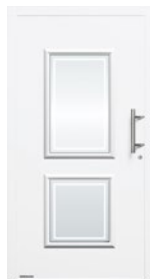

Style 420
Page 55



Style 421
Page 55



Style 422*
Page 57



Style 445
Page 54



Style 503
Page 48



Style 504
Page 51



Style 505
Page 51



Style 514
Page 53

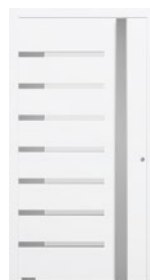

Style 524
Page 53



Style 560
Page 49



Style 565
Page 47



Style 568
Page 47



Style 757
Page 53



Style 759
Page 53



Style 777
Page 52

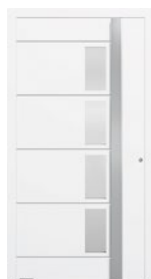

Style 779
Page 52



Style 797
Page 52



Style 799
Page 52



Style 823
Page 46



Style 832
Page 47



Styles 825 / 845 /
855
Page 59



Styles 875 / 895 /
898
Page 59



NEW. Style 878*
Page 44



Style 879
Page 50



Style 891*
Page 57

→ Further information can be found starting on page 44.



Style 140
Page 49



Style 166
Page 49



Style 173
Page 61



Style 177
Page 53



Style 185
Page 48



Style 188
Page 60



Style 189
Page 51



Style 402
Page 54



Style 451
Page 56



Style 453
Page 56



Style 454*
Page 57



Style 455
Page 56



Style 457
Page 56



Style 459*
Page 57



Style 501
Page 53



Style 502
Page 52



Style 650
Page 45



Style 680
Page 45



Style 686
Page 51



Style 689
Page 50

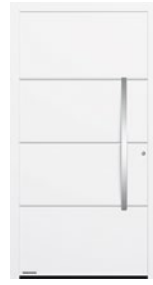

Style 693
Page 60



Style 694
Page 54



Style 697
Page 50



Style 723
Page 51



Style 836
Page 47



Style 860
Page 45



Style 861
Page 60

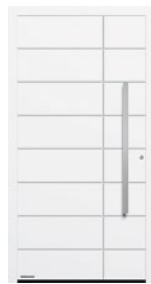

Style 862
Page 60



Style 867
Page 50



Style 871
Page 61



Style 872
Page 61



Style 877
Page 50

* Not available as ThermoSafe Hybrid

Design overview

THERMOPLAN HYBRID

THERMOCARBON

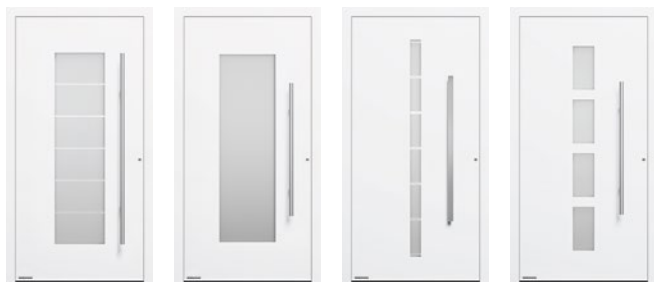

Style 137
Page 63

Style 138
Page 63

Style 189
Page 63

Style 501
Page 63

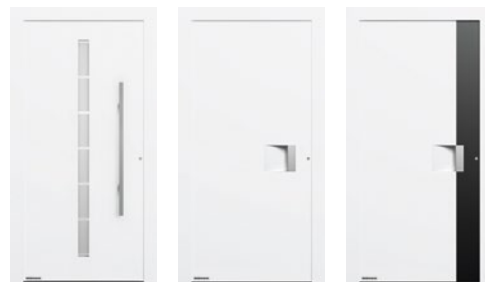

Style 189
Page 69

Style 300
Page 66

Style 301
Page 67



Style 502
Page 63

Style 503
Page 62

Style 504
Page 63

Style 505
Page 63



Style 305
Page 67

Style 306
Page 67

Style 308
Page 67



Style 565
Page 65

Style 568
Page 65

Style 686
Page 65

Style 689
Page 64



Style 312
Page 68

Style 314
Page 68

Style 504
Page 69



Style 723
Page 65

Style 823
Page 65

Style 860
Page 63

Style 862
Page 64



Style 650
Page 68

Style 680
Page 68

Style 686
Page 69



Style 867
Page 64

Style 871
Page 64

Style 872
Page 64



Style 862
Page 69

→ Further information can be found starting on page 62.

→ For further information, see from page 66.

TOPCOMFORT

TOPCOMFORT PORTAL



Style 302
Page 68

Style 304
Page 68



Style 100
Page 70

Style 101
Page 70



Style 138
Page 73



Style 501
Page 73



Style 309
Page 67

Style 310
Page 67

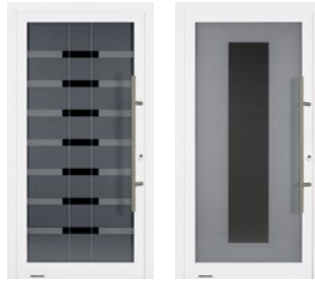

Style 100
MG 111
Page 71

Style 100
MG 112
Page 71



Style 503
Page 73



Style 504
Page 73



Style 565
Page 69

Style 568
Page 69

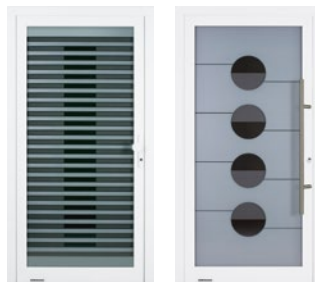

Style 100
MG 113
Page 71

Style 100
MG 114
Page 71



Style 565
Page 72



Style 568
Page 72



Style 823
Page 69

Style 860
Page 69

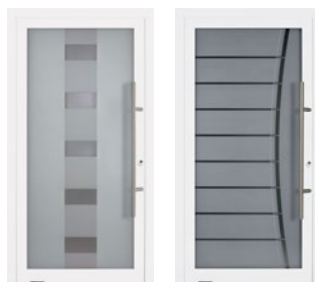

Style 100
MG 115
Page 71

Style 100
MG 116
Page 71



Style 860
Page 72

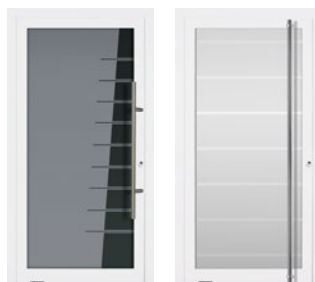

Style 100
MG 117
Page 71

Style 100
Glazing on request
Page 71

→ Further information can be found starting on page 70.

→ For further information, see from page 72.

ThermoSafe / ThermoSafe Hybrid

Exclusive class / extra class



Flush-fitting transition
on the inside



RC3 security
As standard for all ThermoSafe doors and
all ThermoSafe Hybrid doors with glazing



RC4 security
As standard for all ThermoSafe Hybrid doors
with security lock H5 and without glazing



Acoustic insulation
up to 30 dB (ThermoSafe)
up to 33 dB (ThermoSafe Hybrid)



**Very good
thermal insulation**
U_D-value of up to 0.87 W/(m²·K)

Only from Hörmann



**Door leaf exterior made
of stainless steel with
high-quality powder coating**
ThermoSafe Hybrid

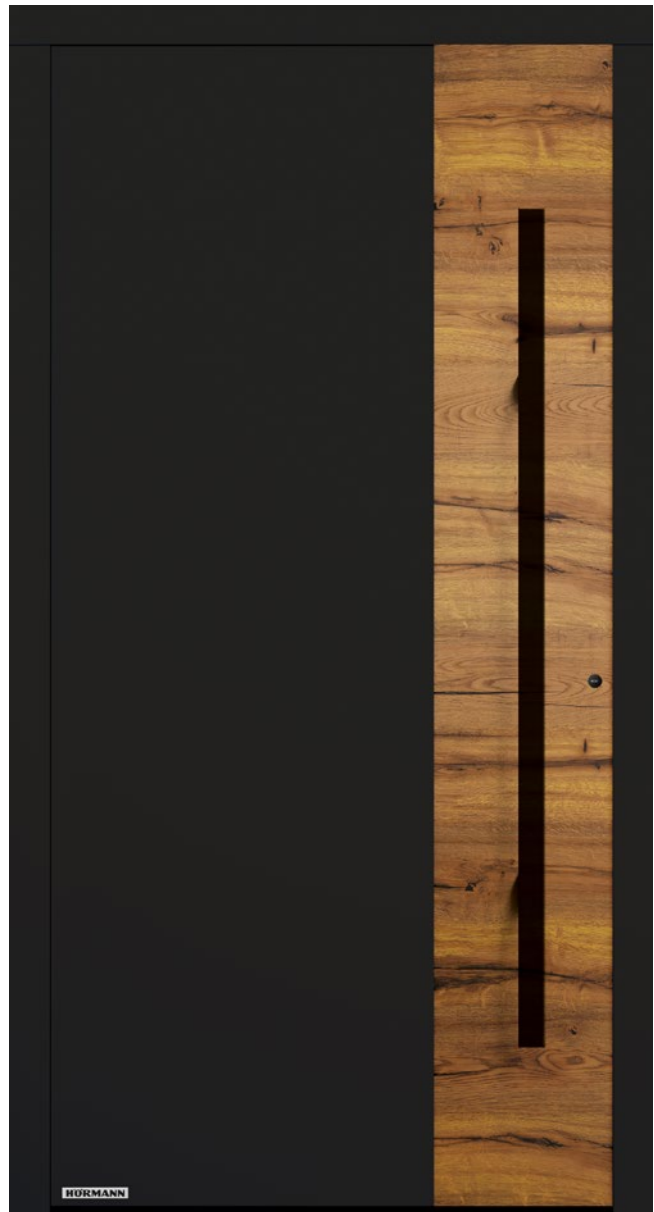

NEW. Style 878

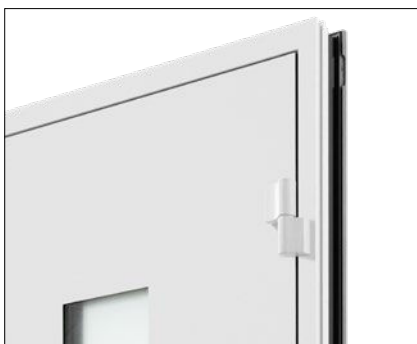

Solid door view on the outside
(top figure) and inside (bottom figure)
as well as a flush-fitting transition
from the door leaf to the door frame
on the inside



Style 650



Style 680

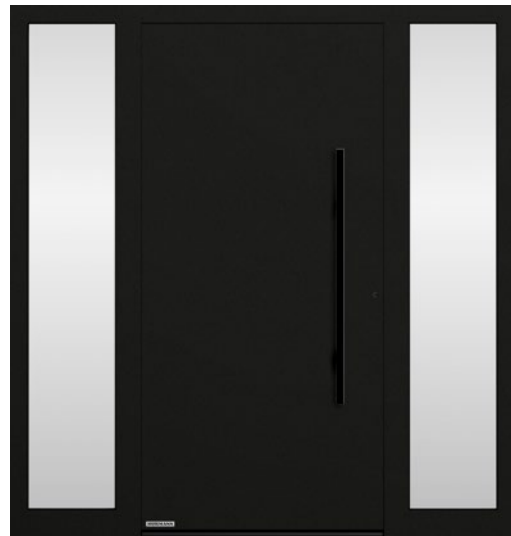

Style 860

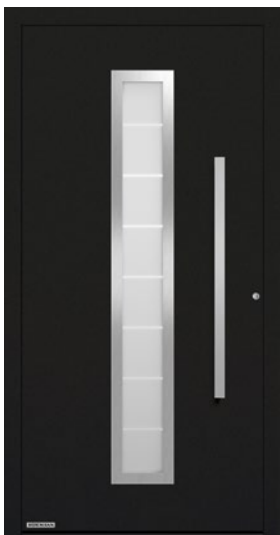

Style 65



Style 45

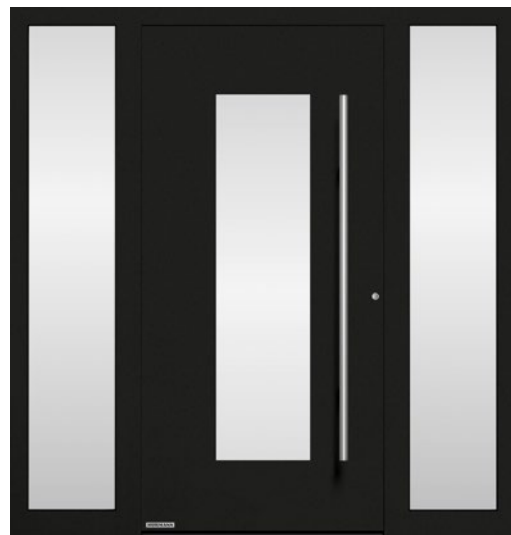

NEW. Style 137

THERMOSAFE / THERMOSAFE HYBRID

All door styles on this page in Jet black RAL 9005 matt fine structure

Style 878* stainless steel handle HOE 501 black.edition in RAL 9005 Jet black matt fine structure (optional), application in MatchDecor Barnwood

Style 650 stainless steel handle HOE 700, matt float ornamental glass

Style 680 stainless steel handle HOE 700, Pave white ornamental glass

Style 860 stainless steel handle HOE 501 black.edition in RAL 9005 Jet black matt fine structure (optional), side elements with matt float ornamental glass

Style 65 stainless steel handle HOE 600, matt float design glass with 7 clear stripes

Style 45 stainless steel handle HOE 200, matt Parsol grey design glass with 4 clear stripes

Style 137 stainless steel handle HOE 735, matt float ornamental glass glazing, side elements with matt float ornamental glass

* Not available as ThermoSafe Hybrid

→ You will find all colours and surface finishes from page 74.

ThermoSafe / ThermoSafe Hybrid

Exclusive class / extra class

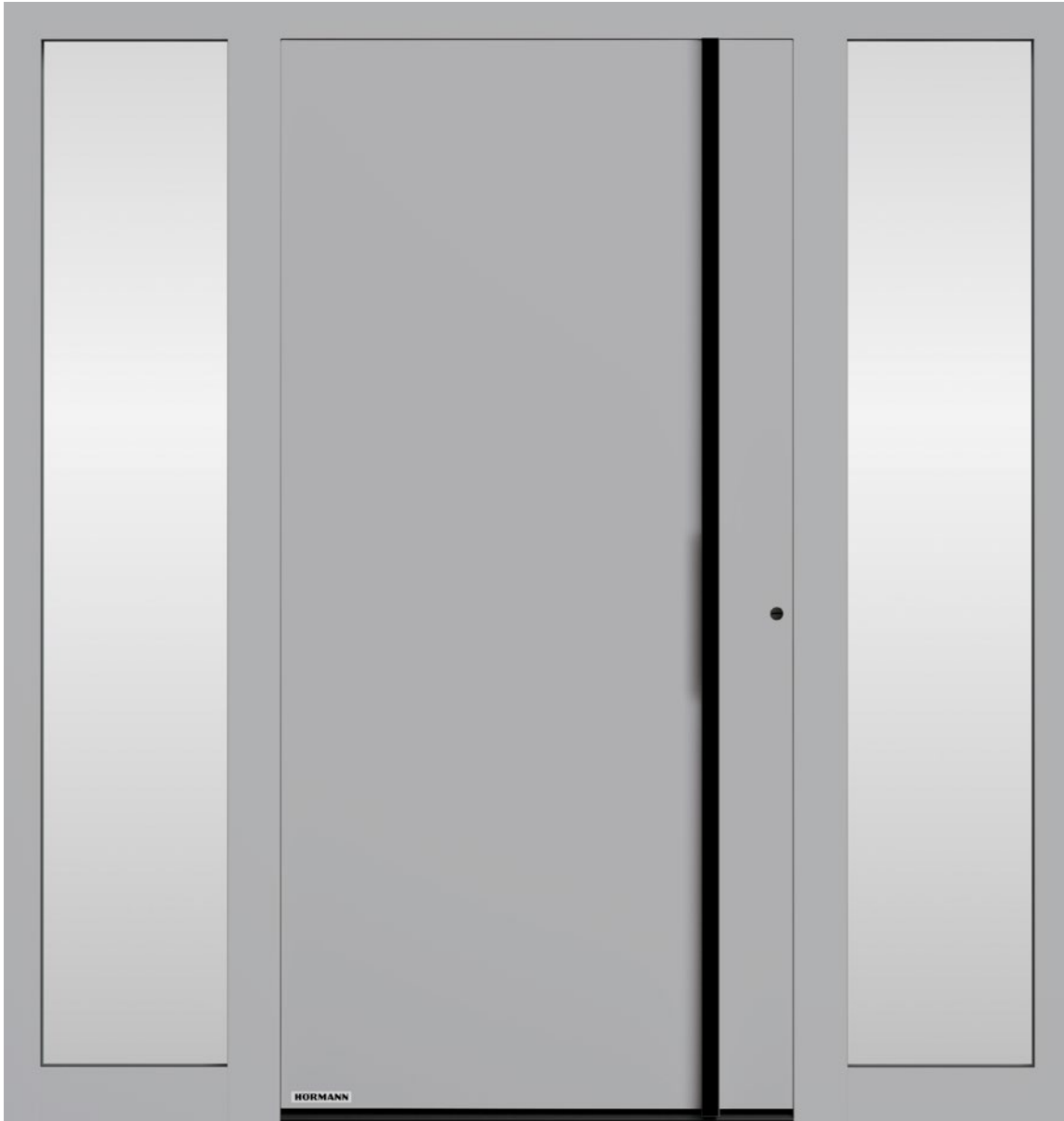

Style 823

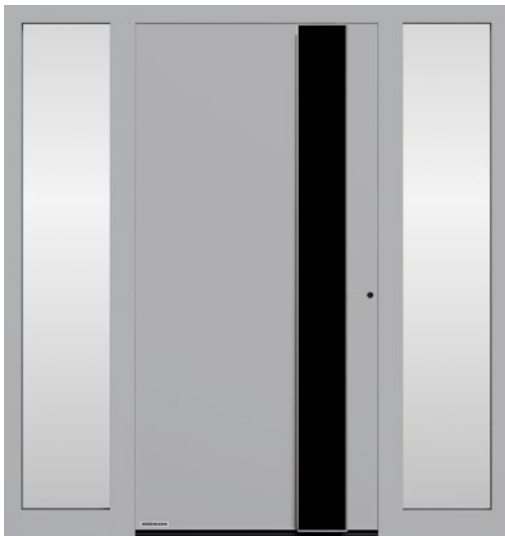

Style 565

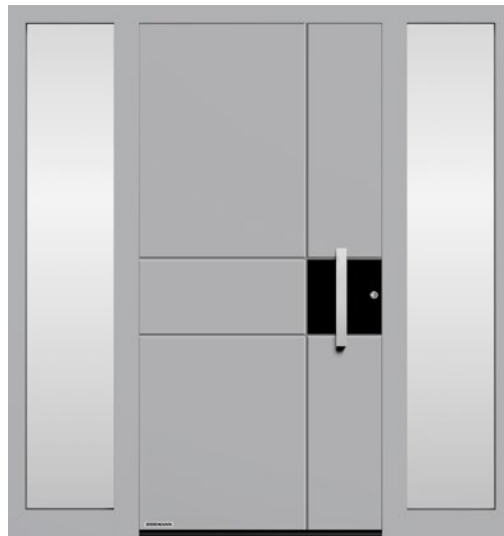

Style 832

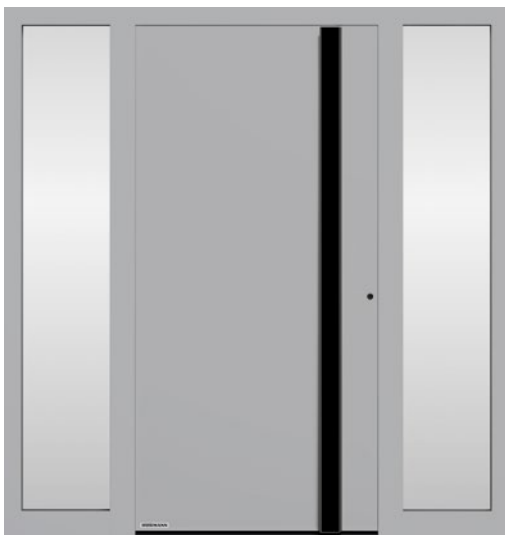

Style 568

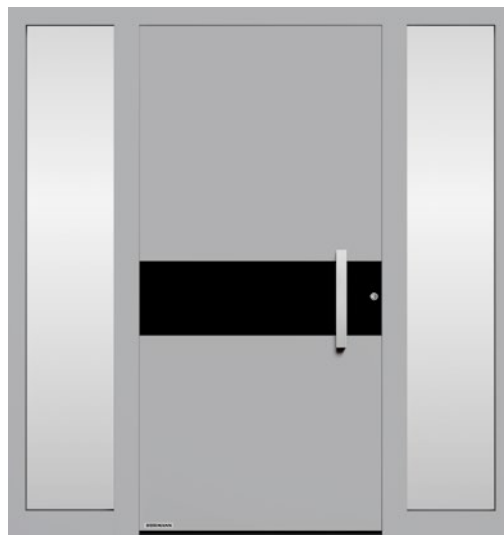

Style 836

THERMOSAFE / THERMOSAFE HYBRID

All door styles on this double page in White aluminium RAL 9006 silk-gloss

Style 823 design handle G 790 black.edition in Jet black RAL 9005 matt fine structure (optional), optionally with integrated LED light strip, side elements with matt float ornamental glass

Style 565 design handle G 760 black.edition in Jet black RAL 9005 matt fine structure (optional), optionally with integrated LED light strip, side elements with matt float ornamental glass

Style 832 stainless steel handle HOE 820, side elements with matt float ornamental glass

Style 568 design handle G 750 black.edition in Jet black RAL 9005 matt fine structure (optional), optionally with integrated LED light strip, side elements with matt float ornamental glass

Style 836 stainless steel handle HOE 820, side elements with matt float ornamental glass

→ You will find all colours and surface finishes from page 74.

ThermoSafe / ThermoSafe Hybrid

Exclusive class / extra class



Style 185

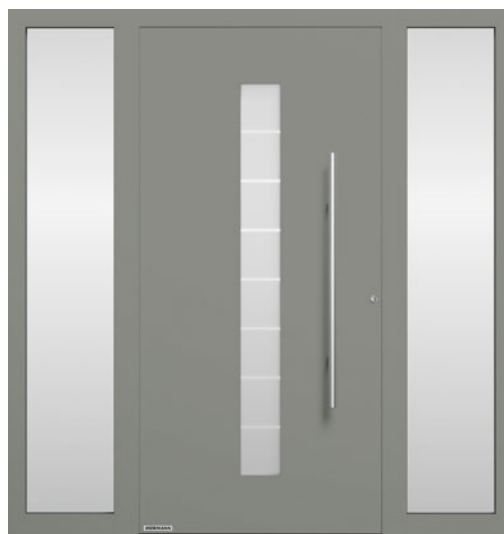

Style 503



Style 75

THERMOSAFE / THERMOSAFE HYBRID

All door styles on this page in Grey aluminium RAL 9007 matt fine structure

Style 185 stainless steel handle 38-2, white Master-Carré ornamental glass

Style 503 stainless steel handle HOE 500, matt float design glass with 7 clear stripes, side elements with matt float ornamental glass

Style 75 stainless steel handle 38-1, matt float ornamental glass, side elements with matt float ornamental glass

→ You will find all colours and surface finishes from page 74.



Style 110



Style 138



Style 136



Style 140



Style 166



Style 560

THERMOSAFE / THERMOSAFE HYBRID

All door styles on this page in Hörmann colour CH 703-AM Anthracite Metallic matt fine structure

Style 110 stainless steel handle 38-1, Cathedral white ornamental glass (optional)

Style 138 stainless steel handle HOE 500, satin-finished float ornamental glass

Style 136 stainless steel handle 38-1, design glass with partially matt outer pane and centre pane from satin-finished float glass with 7 horizontal matt stripes, side element with matt float ornamental glass

Style 140 stainless steel handle 38-1, stainless steel application, Pave white ornamental glass

Style 166 stainless steel handle 38-1, stainless steel application, design glass with partially matt outer pane and centre pane from satin-finished float glass with 7 horizontal matt stripes

Style 560 stainless steel handle HOE 600, design glass with matt outer pane and 11 horizontal clear stripes and centre pane from satin-finished float glass, side element with float ornamental glass

→ You will find all colours and surface finishes from page 74.

ThermoSafe / ThermoSafe Hybrid

Exclusive class / extra class

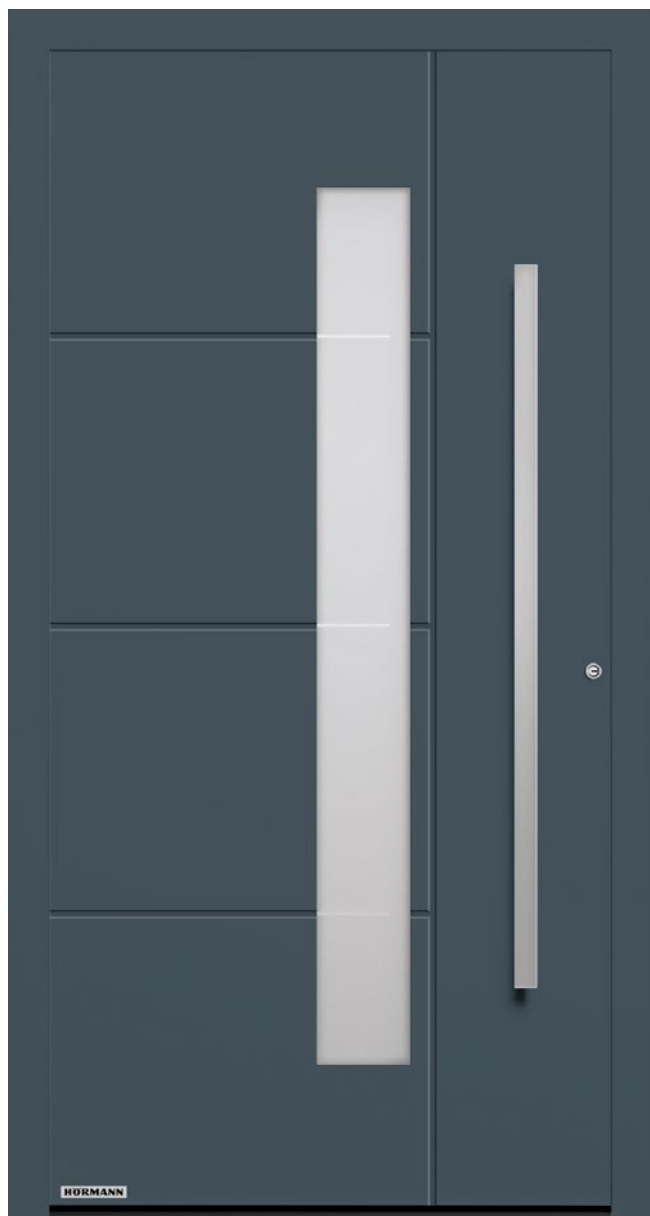

Style 877



Style 879

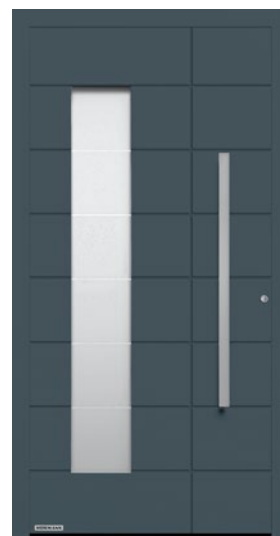

Style 867



Style 697



Style 689

THERMOSAFE / THERMOSAFE HYBRID

All door styles on this page in Slate grey RAL 7015 matt

Style 877 stainless steel handle HOE 610, matt float design glass with 3 clear stripes

Style 879 design handle G 750 in anodised aluminium E6 / EV 1, matt float design glass with 3 clear stripes

Style 867 stainless steel handle HOE 620, matt float design glass with 7 clear stripes

Style 697 stainless steel handle HOE 910, matt Parsol grey design glass with 7 clear stripes

Style 689 stainless steel handle 38-2, matt Parsol grey design glass with 7 clear stripes

→ You will find all colours and surface finishes from page 74.



Style 723



Style 189

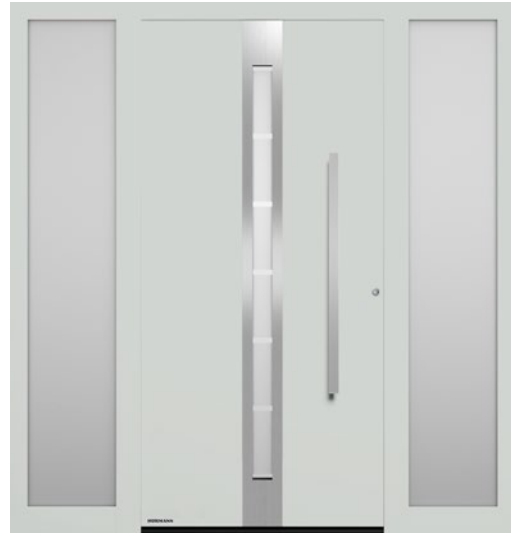

Style 686



Style 504



Style 505

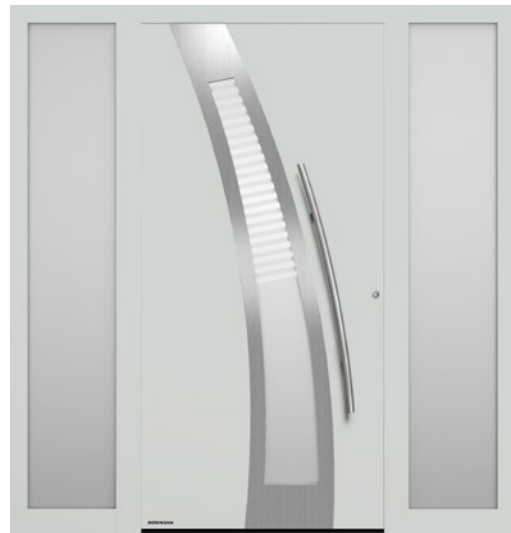

Style 40

THERMOSAFE / THERMOSAFE HYBRID

All door styles on this page in Light grey RAL 7035 matt

Style 723 handle bar G 790 in White aluminium RAL 9006 silk-gloss, handle supports in door colour, satin-finished float ornamental glass

Style 189 stainless steel handle HOE 615, matt float design glass with 7 clear strips

Style 686 stainless steel handle HOE 600, stainless steel application, matt float design glass with 7 clear stripes, side elements with matt float ornamental glass

Style 504 stainless steel handle HOE 500, matt float design glass with 5 clear horizontal stripes

Style 505 stainless steel handle HOE 500, matt float design glass with 4 clear strips

Style 40 stainless steel handle HOE 550, partially matt design glass, side elements with matt float ornamental glass

→ You will find all colours and surface finishes from page 74.

ThermoSafe / ThermoSafe Hybrid

Exclusive class / extra class



Style 502



Style 797



Style 799



Style 777



Style 779

THERMOSAFE / THERMOSAFE HYBRID

All door styles on this page in Traffic white RAL 9016 matt

Style 502 stainless steel handle HOE 500, satin-finished float glazing

Style 797 stainless steel handle HOE 797, matt float ornamental glass

Style 799 design handle G 750 in anodised aluminium E6 / EV 1, matt float ornamental glass

Style 777 stainless steel handle HOE 610, matt float ornamental glass

Style 779 design handle G 750 in anodised aluminium E6 / EV 1, matt float ornamental glass

→ You will find all colours and surface finishes from page 74.



Style 757



Style 759



Style 524



Style 501



Style 177



Style 514

THERMOSAFE / THERMOSAFE HYBRID

All door styles on this page in Quartz grey RAL 7039 matt fine structure

Style 757 stainless steel handle HOE 797, matt float design glass with clear stripes

Style 759 design handle G 750 in anodised aluminium E6 / EV 1, matt float design glass with clear stripes

Style 524 design handle G 750 and applications in RAL 9005 Jet black matt fine structure (optional), glazing with black glass, side elements with black glass (optional)

Style 501 stainless steel handle HOE 500, satin-finished float glazing

Style 177 stainless steel handle HOE 700, Pave white ornamental glass

Style 514 design handle G 750 in White aluminium RAL 9006 silk-gloss, clear float glazing, side elements with sand-blasted float ornamental glass

→ You will find all colours and surface finishes from page 74.

ThermoSafe / ThermoSafe Hybrid

Exclusive class / extra class



Style 402



Style 414



Style 413



Style 445



Style 694

THERMOSAFE / THERMOSAFE HYBRID

All door styles on this page in Traffic white RAL 9016 matt

Style 402 stainless steel handle 14-2, ornamental frame, partially matt Reflo design glass with genuine fluted glass

Style 414 stainless steel handle 14-2, ornamental frame, Silk ornamental glass

Style 413 stainless steel handle 14-2, ornamental frame, Silk ornamental glass

Style 407 stainless steel handle 14-2, milled grooves, matt float design glass with clear edge

Style 419 stainless steel handle 14-2, ornamental frame, leaded ornamental design glass with sand-blasted Reflo base glass (optional)

Style 445 stainless steel handle 38-1, ornamental frame, Chinchilla ornamental glass

Style 694 stainless steel handle HOE 700, ornamental frame, Reflo design glass with genuine fluted glass

Style 420 stainless steel handle 14-2, ornamental frame, sand-blasted Reflo design glass with non-matt edge

Style 421 stainless steel handle 14-2, ornamental frame

→ You will find all colours and surface finishes from page 74.



Style 407



Style 419



Style 420



Style 421



Interior view with smooth door leaf as standard, taking style 421 as an example



Optional interior view, taking style 421 as an example

STYLISH INSIDE AND OUT.

On request, the inside of our classic designs is available in a door view matching the outside. Your entrance door harmonises perfectly with classic residential internal doors in your home.

ThermoSafe / ThermoSafe Hybrid

Exclusive class / extra class



Style 453



Style 451



Style 455



Style 457

THERMOSAFE / THERMOSAFE HYBRID

All door styles on this page in Stone grey RAL 7030 matt fine structure

Style 453 stainless steel handle 14-2, ornamental frame

Style 451 stainless steel handle 14-2, ornamental frame, sand-blasted Reflo design glass with non-matt edge

Style 455 stainless steel handle 14-2, ornamental frame, sand-blasted Reflo design glass with non-matt edge

Style 457 stainless steel handle 14-2, ornamental frame, side elements with satin-finished float ornamental glass

→ You will find all colours and surface finishes from page 74.



Style 454

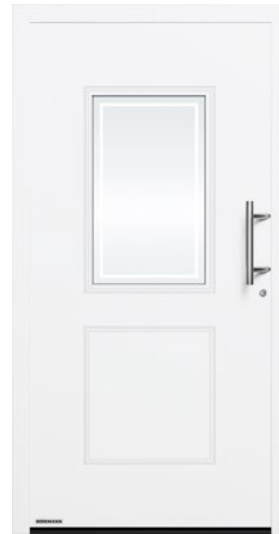

Style 422



Style 459



Style 891

THERMOSAFE / THERMOSAFE HYBRID

All door styles on this page in Traffic white RAL 9016 matt

Style 454* stainless steel handle 14-2, milled grooves, sand-blasted Reflo design glass with non-matt edge

Style 422* stainless steel handle 14-2, milled grooves, sand-blasted Reflo design glass with non-matt edge

Style 459* stainless steel handle 14-2, milled grooves, solid style

Style 891* stainless steel handle 62-1, side elements with matt float ornamental glazing

* Not available as ThermoSafe Hybrid

→ You will find all colours and surface finishes from page 74.

ThermoSafe / ThermoSafe Hybrid

Garage door and entrance door with a matching look



PERFECTLY MATCHING ENTRANCE DOOR AND GARAGE DOOR. The extensive Hörmann range with matching products provides you with aligned entrance door and garage door ribbing options for a matching appearance. The result: No offset from the base line. Together with the MatchColor preferred colours, you can enjoy the harmonious overall appearance thanks to matching colours. You will see: The beauty of your home reflected in these small but crucial details.

→ Further information on the preferred colours can be found on page 74.



For more detailed information on the garage doors, please see the "Sectional garage doors" brochure.



Styles 825 / 845 / 855



Sectional garage door
M-ribbed Silkgrain, Traffic white RAL 9016 matt



Styles 875 / 895 / 898



Sectional garage door
L-ribbed Silkgrain, Traffic white RAL 9016 matt



The cross-section of the entrance **1** and garage door **2** clearly shows the ribbed look of the entrance door is a result of the grooves in the infill. In the garage door, it comes from the ribbing of the individual sections and the section transitions. The aligned appearance also applies if the entrance door has a different installation height than the garage door. We can adjust the groove heights individually according to your specifications, all we need is the height offset. After precise measurement on site, your Hörmann specialist dealer will advise you on the ideal overall look based on these entrance door styles.

ThermoSafe / ThermoSafe Hybrid

Garage door and entrance door with a matching look

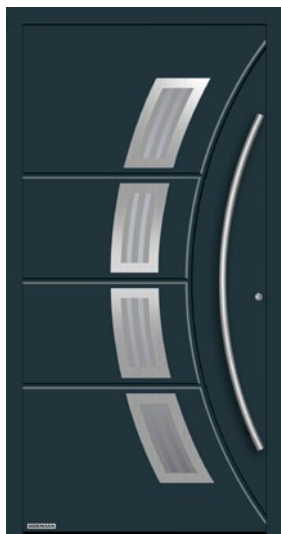

Style 188



Sectional garage door
L-ribbed design style 457 in Silkgrain, Anthracite grey RAL 7016 matt

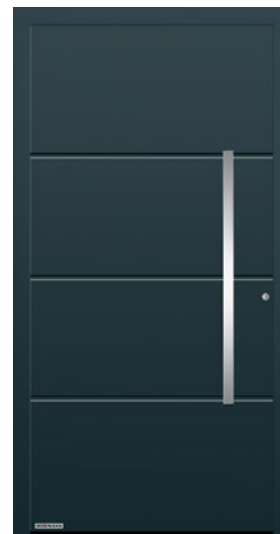

Style 693



Style 861



Sectional garage door
M-ribbed, Silkgrain Anthracite grey RAL 7016 matt



Style 862

MATCHING ENTRANCE AND GARAGE DOORS.

With matching design elements and styles, your entrance door becomes an attractive eye-catcher combined with the sectional garage door.

In these styles, the groove spacing of the entrance door and the ribbing spacing of the garage door are not completely flush.



Style 871



Style 173

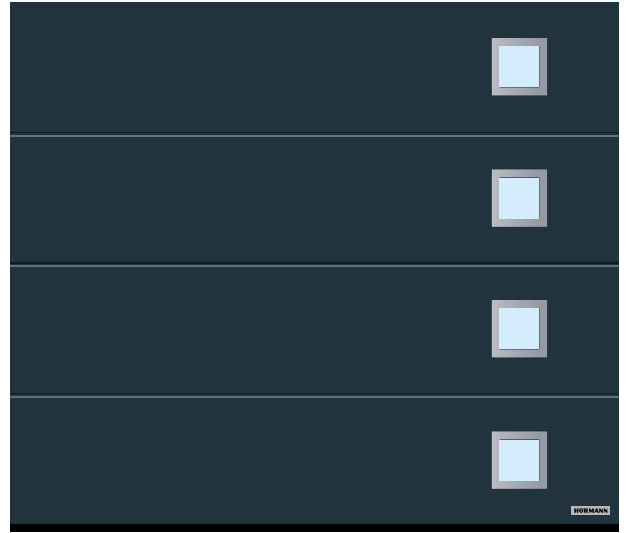

Sectional garage door
L-ribbed design style 461 in Silkgrain, Anthracite grey RAL 7016 matt



Style 872



Sectional garage door
D-ribbed, Silkgrain Anthracite grey RAL 7016 matt

THERMOSAFE / THERMOSAFE HYBRID

All door styles on this double-page spread in Anthracite grey RAL 7016 matt fine structure

Style 188 stainless steel handle HOE 100, matt float design glass with 3 clear stripes

Style 693 stainless steel handle HOE 300

Style 871 stainless steel handle HOE 620

Style 173 stainless steel handle HOE 300, optionally with matt float ornamental glass

Style 861 stainless steel handle HOE 700

Style 862 stainless steel handle HOE 620

Style 872 stainless steel handle HOE 615, side elements with matt float ornamental glass

→ You will find all colours and surface finishes from page 74.

ThermoPlan Hybrid

Design class



Flush-fitting transition
on the interior and exterior



RC3 security
As standard



Acoustic insulation
Up to 33 dB



Very good thermal insulation
 U_D -value of up to 0.78 W/(m²·K)

Only from Hörmann



Door leaf exterior made of stainless steel with high-quality powder coating



Style 503

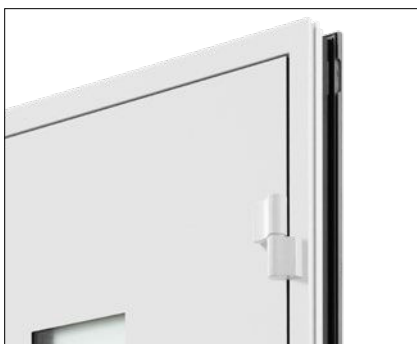

Solid door view and flush-fitting transition from the door leaf to the door frame on the outside (top figure) and inside (bottom figure).



Style 189



Style 860



Style 501



Style 502



NEW. Style 137



Style 138



Style 504



Style 505

THERMOPLAN HYBRID

All door styles on this page in Anthracite grey RAL 7016 matt fine structure

Style 503 stainless steel handle HOE 500, matt float design glass with 7 clear strips

Style 189 stainless steel handle HOE 615, matt float design glass with 7 clear strips

Style 860 stainless steel handle HOE 700

Style 501 stainless steel handle HOE 500, satin-finished float glazing

Style 502 stainless steel handle HOE 500, satin-finished float glazing

Style 137 stainless steel handle HOE 735, matt float design glass with 5 clear strips

Style 138 stainless steel handle HOE 500, satin-finished float ornamental glass

Style 504 stainless steel handle HOE 500, matt float design glass with 5 clear stripes

Style 505 stainless steel handle HOE 500, matt float design glass with 4 clear strips

→ You will find all colours and surface finishes from page 74.

ThermoPlan Hybrid

Design class



Style 689

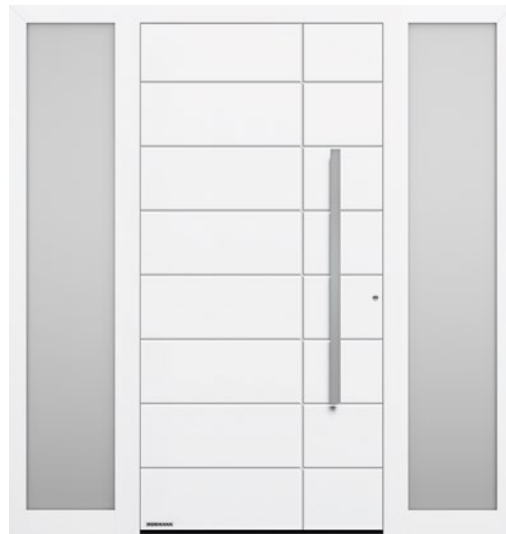

Style 862

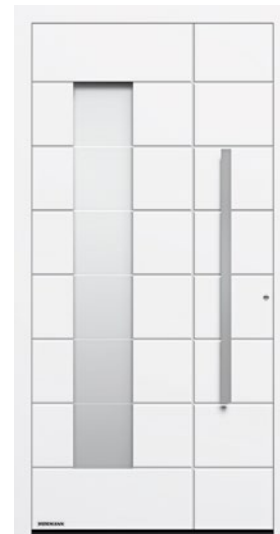

Style 867



Style 871



Style 872

THERMOPLAN HYBRID

All door styles on this page in Traffic white RAL 9016 matt

Style 689 stainless steel handle 38-2, matt Parsol grey design glass with 7 clear stripes

Style 862 stainless steel handle HOE 620, side elements with sand-blasted float ornamental glass

Style 867 stainless steel handle HOE 620, matt float design glass with 7 clear strips

Style 871 stainless steel handle HOE 620, side elements with sand-blasted float ornamental glass

Style 872 stainless steel handle HOE 615, side elements with sand-blasted float ornamental glass

→ You will find all colours and surface finishes from page 74.



Style 565



Style 568



Style 823



Style 686



Style 723

THERMOPLAN HYBRID

All door styles on this page in Traffic white RAL 9016 matt

Style 565 design handle G 760 in White aluminium RAL 9006 silk-gloss, handle application in White aluminium RAL 9006 silk-gloss, side elements with matt float ornamental glass

Style 568 design handle G 750 in White aluminium RAL 9006 silk-gloss, side elements with matt float ornamental glass

Style 823 handle bar G 790 in White aluminium RAL 9006 silk-gloss, handle supports in door colour, side elements with matt float ornamental glass

Style 686 stainless steel handle HOE 615, matt float design glass with 7 clear stripes

Style 723 handle bar G 790 in White aluminium RAL 9006 silk-gloss, handle support brackets in door colour, side elements with matt float ornamental glass

→ You will find all colours and surface finishes from page 74.

ThermoCarbon

Premium class



Thick rebate
on the inside



RC3 security
As standard



RC4 security
Optional



Acoustic insulation
Up to 29 dB



Excellent thermal insulation

Only from Hörmann

ThermoCarbon with a
 U_b -value of up to $0.47 \text{ W/(m}^2\text{K)}$



Style 300



Style 301



Style 308

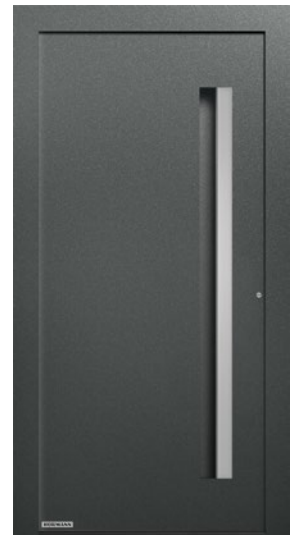

Style 309



Style 305



Style 306



Style 310

THERMOCARBON

All door styles on this page in Hörmann colour CH 703-AM Anthracite Metallic matt fine structure

Style 300 handle bar in White aluminium RAL 9006 silk-gloss

Style 301 flush-fitting aluminium application and handle bar in White aluminium RAL 9006 silk-gloss, side elements with matt float ornamental glass

Style 308 handle bar and recessed grip in RAL 9005 Jet black matt fine structure

Style 309 flush-fitting handle bar in White aluminium RAL 9006 silk-gloss

Style 305 aluminium application in RAL 3003 Ruby red matt, recessed grip in Hörmann colour CH 703-AM Anthracite Metallic matt fine structure, flush-fitting stainless steel handle, side elements with Micrograin ornamental glass

Style 306 recessed grip in Traffic white RAL 9016 matt, flush-fitting stainless steel handle, matt float ornamental glass

Style 310 flush-fitting stainless steel handle, matt float ornamental glass

→ You will find all colours and surface finishes from page 74.

ThermoCarbon

Premium class



Style 304



Style 314



Style 650



Style 312



Style 302



Style 680

THERMOCARBON

All door styles on this page in Traffic white RAL 9016 matt

Style 304 recessed grip in White aluminium RAL 9006 silk-gloss, flush-fitting stainless steel handle, side elements with matt float ornamental glass

Style 314 recessed grip in Traffic white RAL 9016 matt, flush-fitting stainless steel handle, matt float ornamental glass

Style 650 stainless steel handle HOE 700, Pave white ornamental glass

Style 312 flush-fitting handle bar in White aluminium RAL 9006 silk-gloss, matt float design glass with a clear, vertical stripe, side elements with matt float ornamental glass (solid)

Style 302 flush-fitting handle bar in White aluminium RAL 9006 silk-gloss, matt float design glass with a clear, vertical stripe

Style 680 stainless steel handle HOE 700, Pave white ornamental glass

→ You will find all colours and surface finishes from page 74.



Style 860



Style 565



Style 568



Style 823



Style 504



Style 686



Style 189



Style 862

THERMOCARBON

All door styles on this page in Slate grey RAL 7015 matt fine structure

Style 860 stainless steel handle HOE 700

Style 565 design handle G 760 in anodised aluminium E6 / EV 1, handle application in anodised aluminium E6 / EV 1

Style 568 design handle G 750 anodised E6 / EV1

Style 823 handle bar G 790 in White aluminium RAL 9006 silk-gloss, handle support in door colour

Style 504 stainless steel handle HOE 500, matt float design glass with 5 clear horizontal stripes

Style 686 stainless steel handle HOE 610, matt Float design glass with 7 clear stripes

Style 189 stainless steel handle HOE 615, matt float design glass with 7 clear strips

Style 862 stainless steel handle HOE 620

→ You will find all colours and surface finishes from page 74.

TopComfort

Extensive glazing



RC2 security

Optional



RC3 security

Optional



Acoustic insulation

Up to 39 dB (depending on glass type)



Good thermal insulation

U_D -value of up to 1.3 W/(m²·K)



Style 100

Side element with house number on request



Style 101

Side element with letter box system

TOPCOMFORT

All door styles on this page in Traffic white RAL 9016 matt

Style 100 stainless steel handle 38-1, matt float ornamental glass, side elements with matt float ornamental glass

Style 101 stainless steel handle 38-1, Master-Carré ornamental glass, side elements from Master-Carré ornamental glass

→ You will find all colours and surface finishes from page 74.



Style 100
Design glass or ornamental
glass on request



Style 100 MG 111



Style 100 MG 112



Style 100 MG 113



Style 100 MG 114



Style 100 MG 115



Style 100 MG 116



Style 100 MG 117

TOPCOMFORT

All door styles on this page in Anthracite grey RAL 7016 matt

Style 100 design glass, on request stainless steel handle HOE 710, matt float design glass with 7 clear stripes

Style 100 MG 111 stainless steel handle 38-2, matt Parsol grey design glass with 7 continuous clear stripes

Style 100 MG 112, stainless steel handle 38-2, Micrograin design glass with horizontal texture

Style 100 MG 113 stainless steel handle 38-2, design glass with 25 matt stripes

Style 100 MG 114 stainless steel handle 38-2, matt design glass with clear semi-circles and stripes

Style 100 MG 115 stainless steel handle 38-2, matt design glass with rectangles

Style 100 MG 116 stainless steel handle 38-2, design glass with matt stripes and crescent

Style 100 MG 117 stainless steel handle 38-2, matt design glass with 9 clear stripes

→ You will find all colours and surface finishes from page 74.

TopComfort Portal

Double-leaf entrance doors



Acoustic insulation

Up to 29 dB



Good thermal insulation

U_D-value of up to 1.2 W/(m²·K)



Style 860



Style 565



Style 568

TOPCOMFORT PORTAL

All door styles on this page in White aluminium RAL 9006 silk-gloss

Style 860 stainless steel handle HOE 700

Style 565 design handle G 760 in White aluminium RAL 9006 silk-gloss, handle application in White aluminium RAL 9006 silk-gloss

Style 568 design handle G 750 in White aluminium RAL 9006 silk-gloss

→ You will find all colours and surface finishes from page 74.

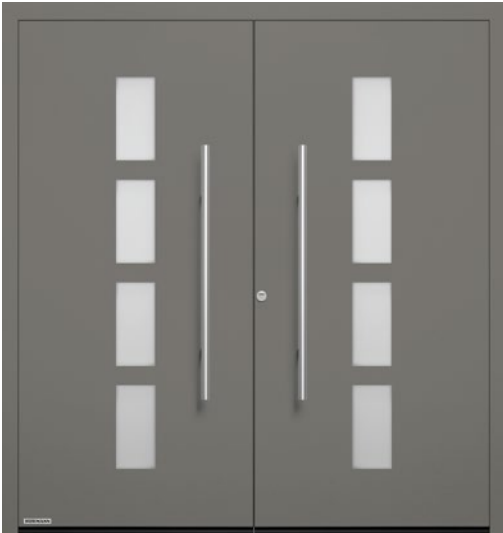

Style 501



Style 138

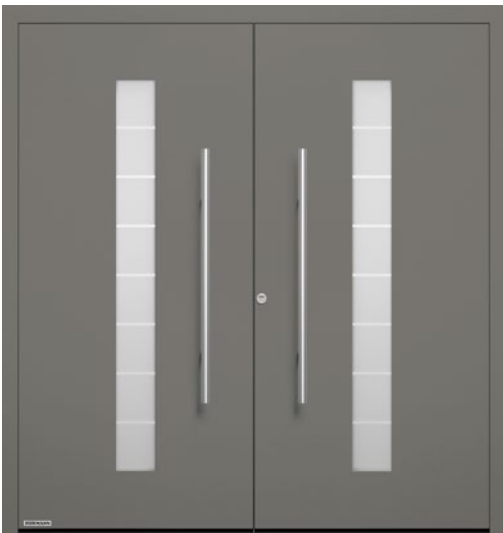

Style 503

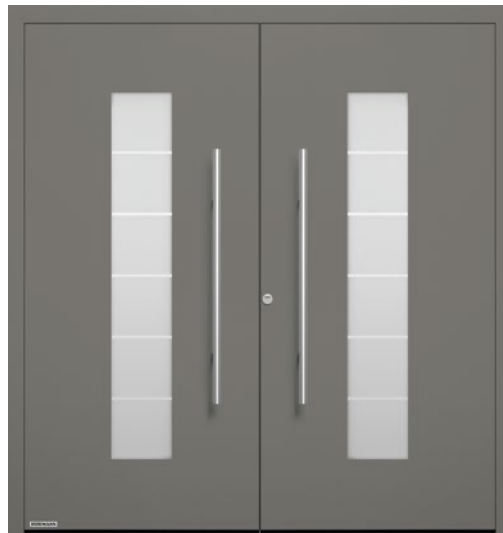

Style 504

TOPCOMFORT PORTAL

All door styles on this page in Grey aluminium RAL 9007 matt fine structure

Style 501 stainless steel handle HOE 500, satin-finished float ornamental glass

Style 138 stainless steel handle HOE 500, satin-finished float ornamental glass

Style 503 stainless steel handle HOE 500, matt float design glass with 7 clear stripes

Style 504 stainless steel handle HOE 500, matt float design glass with 5 clear stripes

→ You will find all colours and surface finishes from page 74.

MatchColor, standard and preferred colours

Individual design options



MatchColor

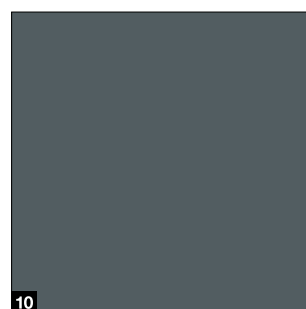
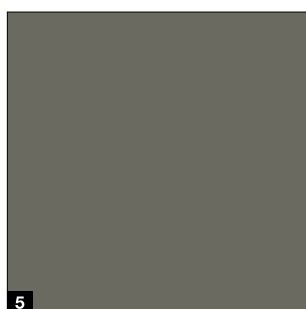
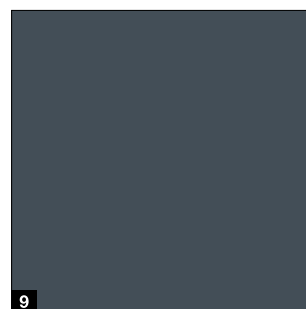
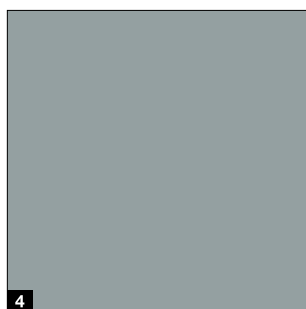
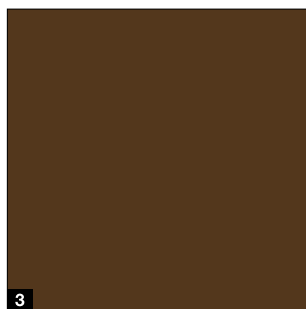
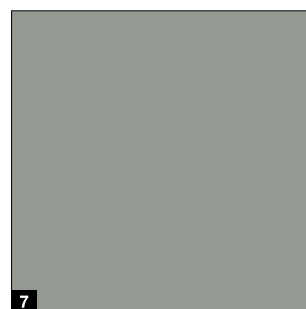
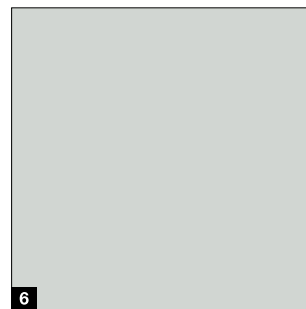
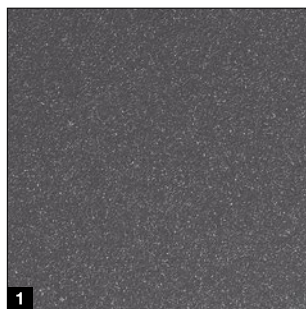

MatchColor

MatchColor

Design your home in perfect colour harmony – with the MatchColor preferred colours for sectional garage doors, entrance doors, side doors and steel doors with a matching appearance. Enjoy the harmonious overall look thanks to matching colours. That is Hörmann brand quality!

Standard and preferred colours

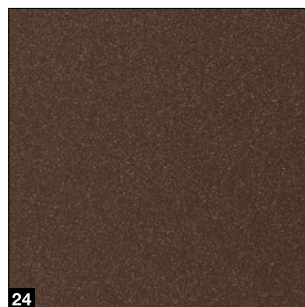
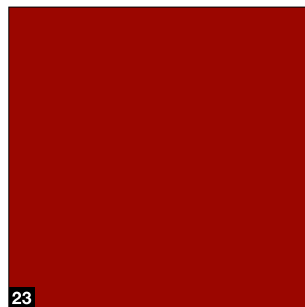
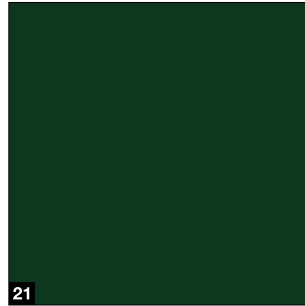
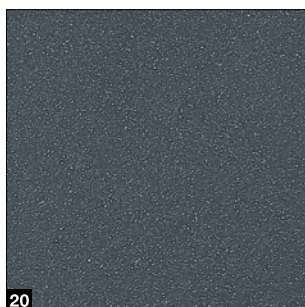
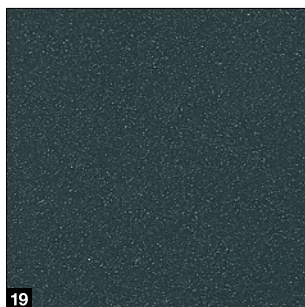
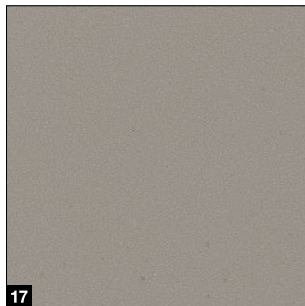
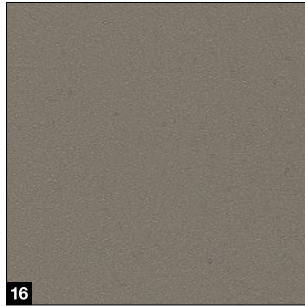
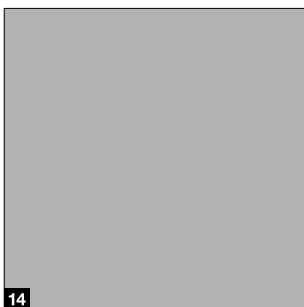
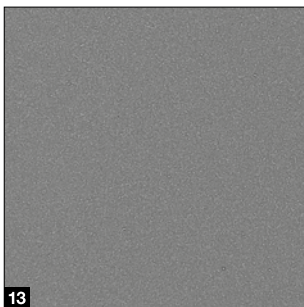
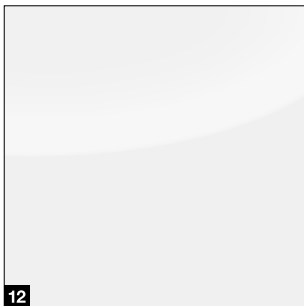
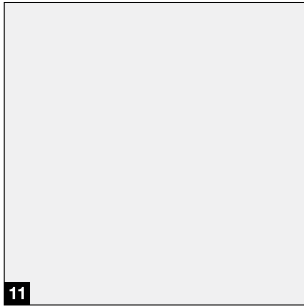

MatchColor

- 1** CH 703-AM Anthracite Metallic, matt fine structure
- 2** RAL 9005 Jet black, matt fine structure
- 3** RAL 8028 Terra brown, matt
- 4** RAL 7040 Window grey, matt
- 5** RAL 7039 Quartz grey, matt
- 6** RAL 7035 Light grey, matt
- 7** RAL 7030 Stone grey, matt
- 8** RAL 7016, Anthracite grey, matt
- 9** RAL 7015 Slate grey, matt
- 10** RAL 7012 Basalt grey, matt

Standard colour

- 11** RAL 9016 Traffic white matt

Preferred colours

- 12** RAL 9016 Traffic white, glossy
- 13** RAL 9007 Grey aluminium, matt fine structure
- 14** RAL 9006 White aluminium, silk-gloss
- 15** RAL 9001 Cream, matt fine structure
- 16** RAL 7039 Quartz grey, matt fine structure
- 17** RAL 7030 Stone grey, matt fine structure
- 18** RAL 7022 Umbra grey, matt
- 19** RAL 7016, Anthracite grey, matt fine structure
- 20** RAL 7015 Slate grey, matt fine structure
- 21** RAL 6009 Fir green, matt
- 22** RAL 6005 Moss green, matt
- 23** RAL 3003 Ruby red, matt
- 24** CH 607 Chestnut, matt fine structure

Please note:

All colours based on RAL. The colours and surface finishes shown are subject to the limitations of the printing process and cannot be regarded as binding.

Please consult with your local Hörmann sales partner.

RAL to choose

All entrance doors are optionally available in around 200 RAL Classic colours (with the exception of pearl-effect and fluorescent colours) as well as in many NCS and dB colours.

Door leaf construction

Completely foamed

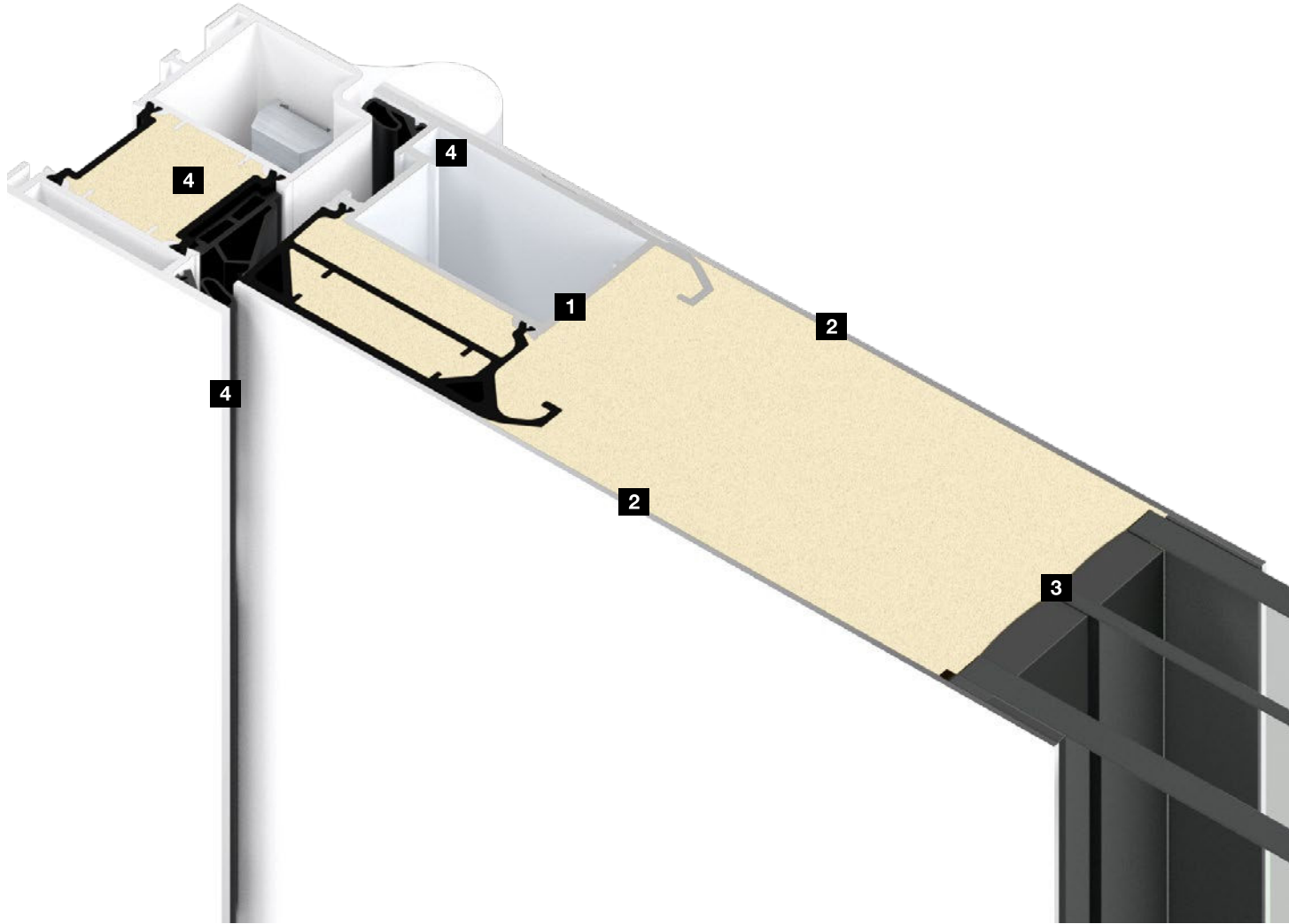

Performance characteristics

ThermoSafe

ThermoSafe Hybrid

Operating forces EN 12217	Up to class 5	Up to class 5
Long-term functionality / mechanical load EN 12400	Up to class 5	Up to class 5
Differential climate behaviour EN 12219	Up to 2d / 2e	Up to 2d / 2e
Air permeability EN 12207	Up to class 4	Up to class 4
Water tightness under heavy rain EN 12208	Up to class 7A	Up to class 7A
Resistance to wind load EN 12210	Up to class C2 / B2	Up to class C2 / B2
Impact resistance EN 13049	Up to class 1	Up to class 1
Mechanical strength EN 1192	Up to class 3	Up to class 3

Notice: The specified performance characteristics indicate the maximum possible performance of the entrance door. This performance may vary according to the equipment of the entrance door.

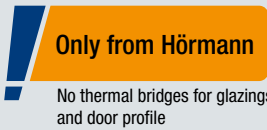

Completely foamed door leaf.

With ThermoSafe, ThermoSafe Hybrid, ThermoPlan Hybrid and ThermoCarbon entrance doors, the PU foam is optimally bonded to the door profile **1**, the internal and external sheets **2** and the glazing **3**. In contrast to other door systems, where the components are only glued together, this elegant construction is characterised by a particularly high dimensional stability and break-in resistance as well as even better thermal insulation, as no thermal bridges are created with glazings.

Multiple sealing system. **4**

Our high-quality seals seal off the leaf, even in case of extreme temperature differences. The interior seal goes all the way around the entire door leaf. The centre and outer door seals are inserted on 3 sides (top and side). All our seals are completely all-round and are not interrupted by the hinge system as with doors from other manufacturers. This sealing system is supplemented by the bottom edge seal, which effectively seals off the threshold. The centre seal impresses visually with its flocking and at the same time ensures that the leaf slides easily into the frame. This also ensures that the lock and cylinder always close smoothly.

ThermoPlan Hybrid	ThermoCarbon	TopComfort	TopComfort Portal
Up to class 5	Up to class 3	Up to class 3	Up to class 5
Up to class 5	Up to class 6	Up to class 5	Up to class 5
Up to 2d / 1e	Up to 2d / 2e	Up to 2d / 2e	Up to 2d / 1e
Up to class 4	Up to class 4	Up to class 4	Up to class 4
Up to class 7A	Up to class 7A	Up to class 5A	Up to class 7A
Up to class C2 / B2	Up to class C2 / B2	Up to class C2	Up to class C2 / B2
Up to class 1	Up to class 5	Up to class 1	Up to class 1
Up to class 3	Up to class 3	Up to class 3	Up to class 3

Door versions

The right profile for any requirement

1 Door profile

2 Door leaf thickness

3 Frame thickness

4 Sealing system

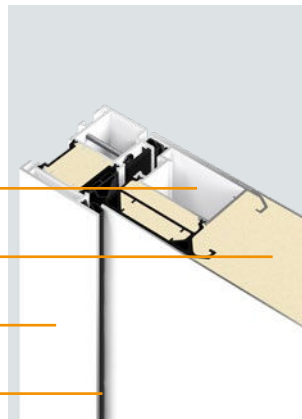

ThermoSafe

ThermoSafe Hybrid

1	Door profile	Interior	Interior
	Material	Aluminium, with thermal break	Aluminium, with thermal break
2	Door leaf thickness	73 mm	73 mm
	External sheet	Aluminium	Stainless steel
	External rebate	Rebated	Rebated
	Internal sheet	Aluminium	Aluminium
	Internal rebate	Flush	Flush
3	Frame thickness	82 mm	82 mm
	Material	Aluminium, with thermal break	Aluminium, with thermal break
	Fitting groove	As standard	As standard
4	Sealing system	triple	triple
	Threshold	Polyamide	Polyamide
	Thermal insulation (U_D-value)*	Up to 0.87 W/(m²·K)	Up to 0.87 W/(m²·K)
	Acoustic insulation	30 dB	30 dB

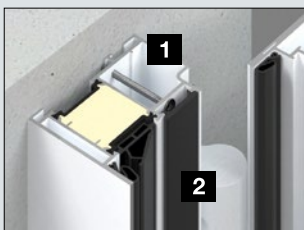

Fitting groove for invisible screwing

Our single-leaf entrance doors without side elements are now equipped as standard with a fitting groove **1** for concealed fitting without any visible screw heads. A high-quality cover strip **2** conceals the groove, creating a beautiful, homogeneous profile view in the rebate area.

* Dependent on door size. Specified values for RAM 1250 × 2200 mm

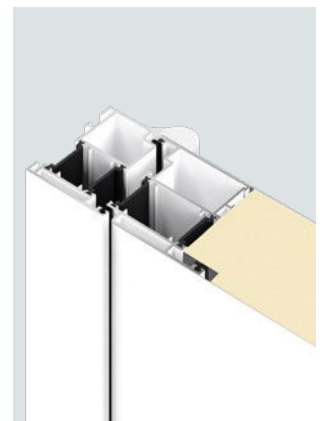
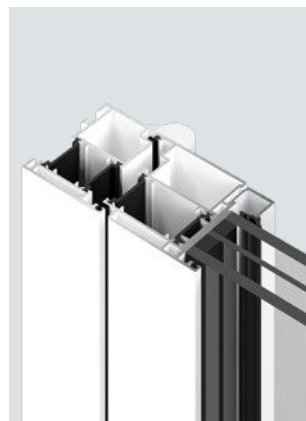
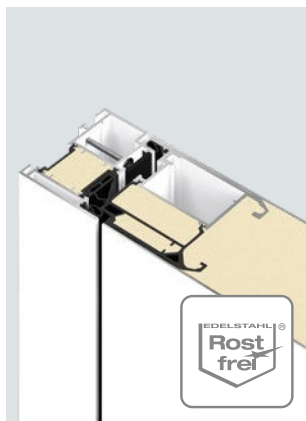

ThermoPlan Hybrid

ThermoCarbon

TopComfort

TopComfort Portal

Interior	Interior	Glazing frame	Interior
Aluminium, with thermal break	Carbon, with thermal break	Aluminium, with thermal break	Aluminium, with thermal break
82 mm	100 mm	80 mm	83 mm
Stainless steel	Aluminium		Aluminium
Flush	Rebated	Flush	Flush
Aluminium	Aluminium		Aluminium
Flush	Rebated	Flush	Flush
82 mm	111 mm	80 mm	80 mm
Aluminium, with thermal break	Aluminium, with thermal break	Aluminium, with thermal break	Aluminium, with thermal break
As standard			
triple	quadruple	double	double
Polyamide	Polyamide	Aluminium / plastic	Aluminium / plastic
Up to 0.78 W/(m²·K)	Up to 0.47 W/(m²·K)	Up to 1.3 W/(m²·K)	Up to 1.2 W/(m²·K)
33 dB	29 dB	29 to 39 dB (depending on glass type)	29 dB



Threshold

The standard threshold **1** is made of high-quality polyamide and creates a bottom edge with thermal break. For a more elegant exterior appearance, we recommend the optional aluminium **2** cover.

Door equipment

For an elegant, functional door design

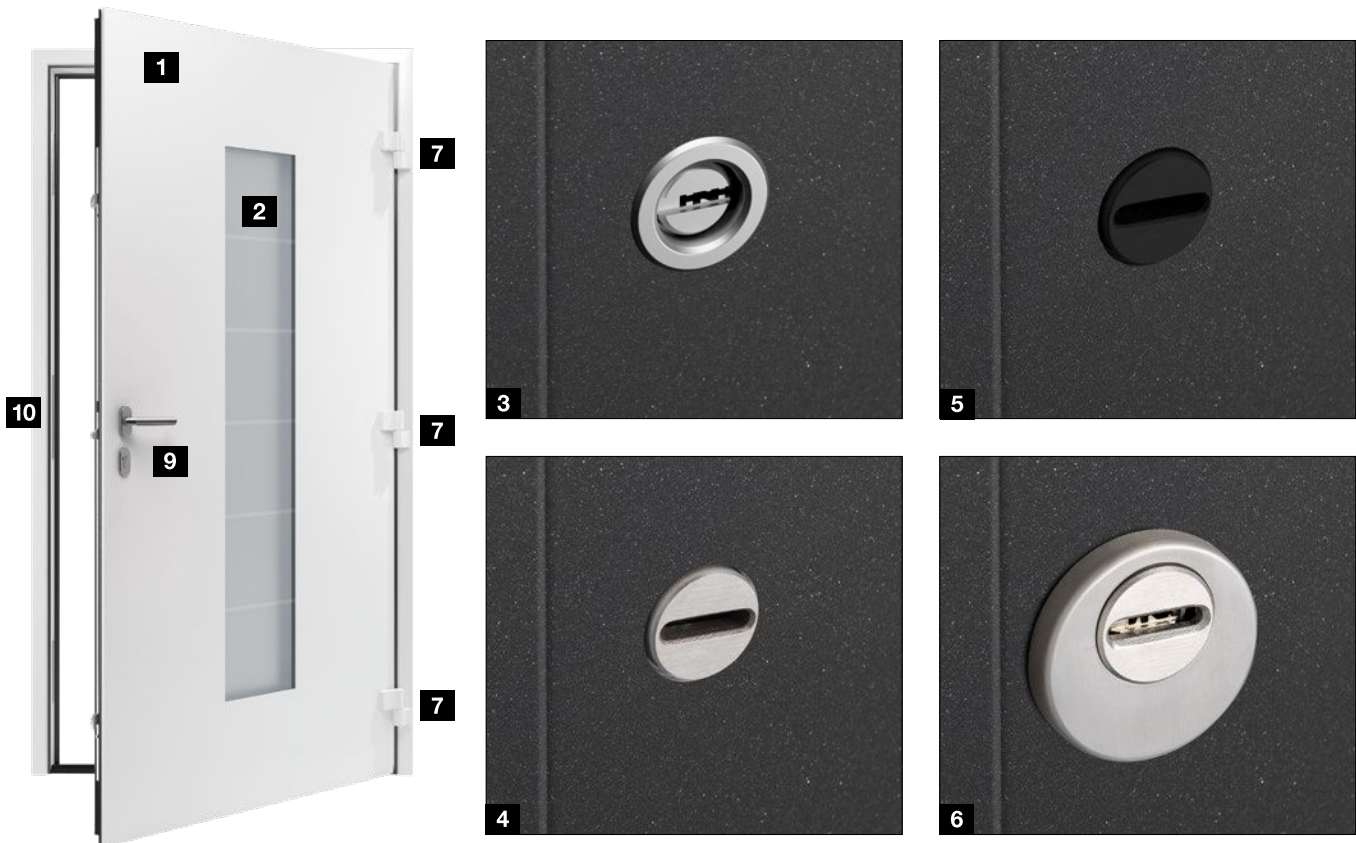

	ThermoSafe	ThermoSafe Hybrid
1 Solid door view from the inside	●	●
2 Insulated glass	Triple glazing	Triple glazing
3 NEW. Profile cylinder with rose escutcheon ring, stainless steel	●	●
4 Profile cylinder with embedded drill-proof panel, stainless steel	○	○
5 NEW. Profile cylinder with embedded drill-proof panel, black	○	○
6 Profile cylinder with surface-mounted security rose escutcheon, stainless steel	-	○ ²⁾
7 3D hinges including leverage protection, Traffic white RAL 9016	●	●
8 Concealed hinges	○	○
9 Interior lever	Stainless steel lever handle CARO	Stainless steel lever handle CARO
10 Stainless steel lock plate	●	●
11 Integrated overhead door closer or overhead door closer HDC 35 (not shown) with mechanical hold-open device	-	-
11 Opening limiter (no figure)	○	○
12 Retractable bottom seal with weather protection	○	○

● = As standard ○ = Optional - = Not available

¹⁾ Style 310 with triple glazing

²⁾ With outward opening version

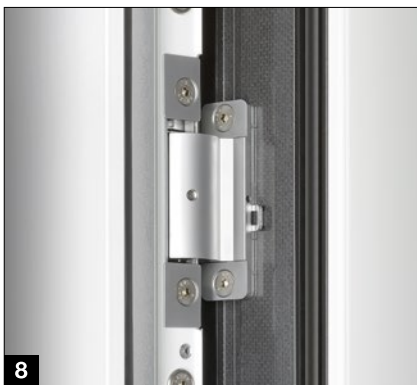
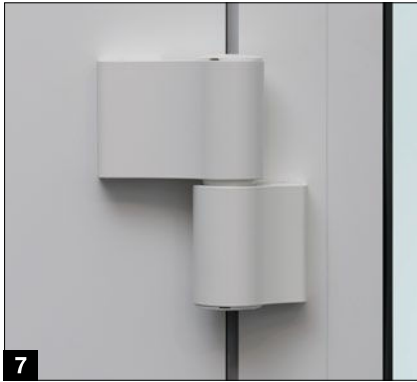

ThermoPlan Hybrid

ThermoCarbon

TopComfort



TopComfort Portal

●	●	●	●
Triple glazing	Quadruple-pane glazing ¹⁾	Triple glazing	Triple glazing
-	-	-	-
●	●	-	-
○	○	-	-
-	-	●	●
●	-	●	●
○	●	○	○
Stainless steel lever handle CARO	Stainless steel lever handle CARO	Aluminium lever handle Rondo, Traffic white RAL 9016	Aluminium lever handle Rondo, Traffic white RAL 9016
●	● (Integrated in rebate)	●	●
-	-	○	○
○	○	○ With scissors limiter	○
-	-	○ Without weather protection	○ Without weather protection

Security features

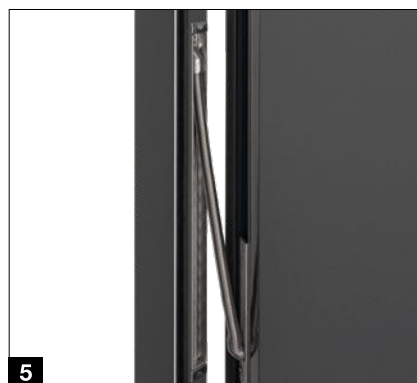
Certified security features as standard



	ThermoSafe	ThermoSafe Hybrid
 RC2 security features	-	-
 RC3 security features	●	●
 RC4 security features	-	● For door styles without glazing and with H5 lock
3 Security lock H5 / H9 with swing bolt and mechanical locking	● H5 with 5-point locking	● H5 with 5-point locking
Electric strike with day / night function	○	○
Electric strike with day / night function and permanently open function	○	○
4 Security lock S5 / S7 Automatic with bolt and mechanical self-locking	■ S5 with 5-point locking	■ S5 with 5-point locking
4 Security lock S5S Automatic with additional locking bar	○ S5S with 5-point locking	○ S5S with 5-point locking
4 Security lock S5 / S7 Comfort / Code / Scan / Smart / BlueSecur with bolt, mechanical self-locking and electrical release	○ S5 with 5-point locking	○ S5 with 5-point locking
5 Electro duct with spiral cable	○	○
6 Electro duct KÜ 240 with short coil cable and fitting groove	-	-
Electro duct with cable duct and vertical / horizontal profile construction	○	○

● = As standard ■ = Optional at no surcharge ○ = Optional - = Not available



RC2 security
Tested and certified

The opportunist burglar attempts to break open the locked door with simple tools within 3 minutes.



RC3 security
Tested and certified

The burglar attempts to break open the locked door with tools, e.g. a crowbar, as well as simple drilling tools within 5 minutes.



RC4 security
Tested and certified

The experienced burglar attempts to break open the locked door with tools, e.g. a crowbar, as well as drilling and striking tools within 10 minutes.



ThermoPlan Hybrid

ThermoCarbon

TopComfort

TopComfort Portal

		<input type="radio"/>	
<input checked="" type="radio"/>	<input checked="" type="radio"/>	<input type="radio"/>	
-	<input type="radio"/>	-	-
<input checked="" type="radio"/> H5 with 5-point locking	<input checked="" type="radio"/> H9 with 9-point locking	<input checked="" type="radio"/> H5 with 5-point locking	<input checked="" type="radio"/> H5 with 5-point locking
<input type="radio"/>	<input type="radio"/>	<input type="radio"/>	<input type="radio"/>
<input type="radio"/>	<input type="radio"/>	<input type="radio"/>	<input type="radio"/>
<input checked="" type="radio"/> S5 with 5-point locking	<input checked="" type="radio"/> S7 with 7-point locking	<input checked="" type="radio"/> S5 with 5-point locking	<input checked="" type="radio"/> S5 with 5-point locking
<input type="radio"/> S5S with 5-point locking	-	<input type="radio"/> S5S with 5-point locking	<input type="radio"/> S5S with 5-point locking
<input type="radio"/> S5 with 5-point locking	<input type="radio"/> S7 with 7-point locking	<input type="radio"/> S5 with 5-point locking	<input type="radio"/> S5 with 5-point locking
<input type="radio"/>	-	<input type="radio"/>	<input type="radio"/>
-	<input type="radio"/>	-	<input type="radio"/>
<input type="radio"/>	-	-	-

Security locks

Smart security

Standard locks

Security lock H5 / H9 (standard)

- Mechanical multiple-point locking with key
- Opening / closing cycle with a single key turn
- Electrical opening via optional electric strike, button or intercom

Security lock S5 / S7 Automatic

(optionally without surcharge)

- Mechanical multiple-point locking:
 - Locks automatically as the door is closed
- Alternatively, manual opening via key or interior lever
- Electric strike not possible

Security lock S5S Automatic (at a surcharge)

- Functions as S5 / S7 Automatic
- Additional integrated locking bar for gap opening



Electrical opening via button or intercom using an optional electric strike

Comfort locks S5 / S7, VdS class B (at a surcharge)

	S5 / S7 Comfort	S5 / S7 Code	S5 / S7 Scan	S5 / S7 BlueSecur	S5 / S7 Smart
Connection to house intercom	●	●	●	●	●
Code switch in the door leaf		●			
Code switch in the lever handle		○			
Finger-scan in the door leaf			●		
Finger-scan in the lever handle			○		
Bluetooth receiver for Hörmann BlueSecur		○	○	●	
BiSecur radio		○	○		●

● = As standard ○ = Optional

S5 = 5-point locking for ThermoSafe, ThermoSafe Hybrid, ThermoPlan Hybrid

S7 = 7-point locking for ThermoCarbon

S5 / S7 Comfort

- Mechanical multiple-point locking: Locks automatically as the door is closed
- **Electrical opening via button or intercom**
- Alternatively, manual opening via key or interior lever



S5 / S7 Code

- Mechanical multiple-point locking: Locks automatically as the door is closed
- **Electrical opening by entering a code (up to 20 codes)**
- **Code keypad (dimensions: 45 x 75 mm) integrated into the door leaf or lever handle HOE 605**
- Alternatively, manual opening via key or interior lever



Brushed stainless steel



Elegantly integrated into the exterior handle HOE 605

Security locks

Smart security

S5 / S7 Scan

- Mechanical multiple-point locking:
Locks automatically as the door is closed
- **Electrical opening by fingerprint**
(up to 80 fingerprints can be stored)
- **NEW. Finger-scan (dimensions: 24 x 52 mm)**
integrated into the door leaf or lever handle
HOE 506-1 / HOE 706-1 / G 850
- **NEW. Concealed solution on the back**
of the G 850 handle
- Alternatively, manual opening via key or interior lever



Brushed stainless steel

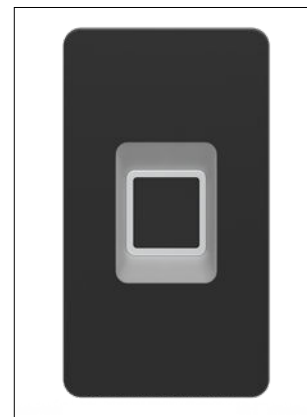

Jet black RAL 9005 matt
fine structure



NEW. Concealed solution
on the back of the G 850 handle



Elegantly integrated into
the exterior handle

S5 / S7 BlueSecur

- Mechanical multiple-point locking:
Locks automatically as the door is closed
- **Electrical opening via smartphone with**
the Hörmann BlueSecur app
- **Hörmann BlueSecur Bluetooth receiver integrated**
into the door frame
- Alternatively, manual opening via key or interior lever

Hörmann BlueSecur App

- User-friendly surface finish
- Transfer user permissions to other smartphones
permanently or temporarily



 **Hörmann BlueSecur**

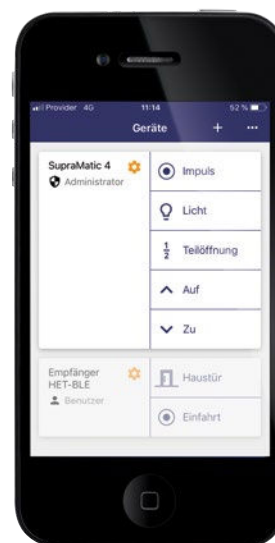

S5 / S7 Smart

- Mechanical multiple-point locking: Locks automatically as the door is closed
- **Electrical opening via hand transmitter, radio switch or Hörmann homee Smart Home system**
- **Hörmann radio receiver 868 Mhz BiSecur integrated into the door frame**
- **Status message via optional latch switching contact in the secondary lock plate**
- Alternatively, manual opening via key or interior lever



Hand transmitter HS 1 BS
1 button function, textured surface matt black



Radio finger-scan FFL 25 BS
2 functions and up to 25 fingerprints, with hinged cover, recessed and surface-mounted fitting possible, plastic housing painted in White aluminium RAL 9006



Radio internal push button FIT 5 BS
4 button functions plus query button for status message, plastic housing in Pure white RAL 9010



Hörmann homee Brain
Basic cube for operating Hörmann garage door and entrance gate operators, entrance door locks, electric devices and perimeter protection systems via the Hörmann homee app



Only from Hörmann

All automatic locks with electric motor can optionally be equipped with the BiSecur radio system, allowing you to conveniently open your entrance door with an optional hand transmitter, radio switch or the Hörmann homee Smart Home system.

Another advantage is that you can use the same hand transmitter to operate your Hörmann garage door or entrance gate. The extremely secure radio system ensures that no unauthorised person can copy your radio signal. All operators, receivers and control elements with the BiSecur radio system are 100% compatible with each other.

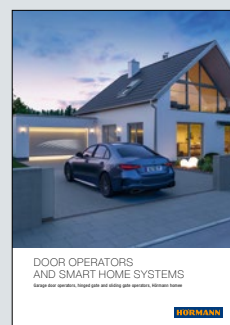

Further information can be found in the "Door operators and Smart Home systems" brochure.

Exterior handles

Tangibly beautiful design



HOE 500
Brushed matt stainless steel
Handle length ¹⁾: 1000 mm

HOE 501 / HOE 739
Brushed stainless steel
Handle length ¹⁾: 1000 mm (HOE 501), 1703 mm (HOE 739)

HOE 501 / HOE 739 black.edition
Jet black RAL 9005 matt fine structure
Handle length ¹⁾: 1000 mm (HOE 501), 1703 mm (HOE 739)

NEW. HOE 506-1
Brushed stainless steel, prepared for a finger-scan
Handle length ¹⁾: 1000 mm

NEW. HOE 506-1 black.edition
Jet black RAL 9005 matt fine structure, prepared for a finger-scan
Handle length ¹⁾: 1000 mm

HOE 600 / 610 / 615
Brushed stainless steel
Handle lengths ¹⁾: 950 mm (HOE 600), 1100 mm (HOE 615), 1250 mm (HOE 610)



NEW. HOE 797
Brushed stainless steel
Handle length ⁷⁾: 1670 mm

HOE 795 / 796
Brushed stainless steel
Handle lengths ²⁾: 1027 mm (HOE 795), 627 mm (HOE 796)

38-1
Polished stainless steel with decorative centre part
Handle length ¹⁾: 1000 mm

38-2
Brushed stainless steel
Handle length ¹⁾: 1000 mm

HOE 800
Polished stainless steel with decorative centre part
Handle length ³⁾: 330 mm

14-1
Polished stainless steel with decorative centre part
Handle length ³⁾: 330 mm

39-1 black.edition
Jet black RAL 9005 matt (not shown)



HOE 605

Brushed stainless steel, prepared for a code switch
Handle length ¹⁾: 1000 mm

HOE 700

Polished stainless steel with decorative centre part
Handle length ¹⁾: 1000 mm

HOE 701

Stainless steel with decorative centre part
Handle length ¹⁾: 1000 mm

NEW. HOE 706-1

Brushed stainless steel, prepared for a finger-scan
Handle length ¹⁾: 1000 mm

HOE 710

Brushed stainless steel
Handle length: adjusted to door height

HOE 730 / HOE 735

Brushed stainless steel
Handle length: 1878 mm⁶⁾ (HOE 730), 1640 mm⁶⁾ (HOE 735)

HOE 740

Brushed stainless steel
Handle length ²⁾: adjusted to door height



14-2

Brushed stainless steel
Handle length ³⁾: 330 mm

14-4

Polished brass
Handle length ³⁾: 330 mm

11-1

Brushed stainless steel
Handle length ³⁾: 290 mm

81-1

Polished brass
Handle length ³⁾: 290 mm

92-2

Brushed stainless steel
Handle length ⁴⁾: 350 mm

94-2

Brushed stainless steel
Handle length ⁵⁾: 300 mm

Spacing of fixings:

¹⁾ 1594 mm / 600 mm

²⁾ 980 mm / 580 mm

³⁾ 210 mm

⁴⁾ 350 mm

⁵⁾ 300 mm

⁶⁾ 1770 mm

⁷⁾ 1630 mm

⁸⁾ 1530 mm

Exterior handles

Design handles, adjusted to the door height



Design handle G 750
Handle bar: Anodised aluminium
or RAL to choose
Handle length: Door height



Design handle G 760
Handle bar: Anodised aluminium
or RAL to choose
Handle application: Anodised aluminium
E6 / EV 1, RAL to choose or MatchDecor
Handle lengths: Door height



NEW. Design handle G 850, 856, 857
Handle bar: RAL to choose
Handle application: RAL to choose
or MatchDecor
Handle lengths: Door height (G 850), 1000 mm
(G 857), height of glazing cut-out (G 856)

Optional lighting in the handle bar



Lever handle sets

Excellent design and security



Stainless steel lever handle CARO

As standard for ThermoCarbon, ThermoSafe, ThermoSafe Hybrid and ThermoPlan Hybrid as well as optionally for TopComfort and TopComfort Portal



Stainless steel lever handle Okto

Optionally for ThermoSafe, ThermoSafe Hybrid, ThermoPlan Hybrid, TopComfort and TopComfort Portal



Aluminium lever handle Rondo

In Traffic white RAL 9016, as standard for TopComfort and TopComfort Portal



Stainless steel lever handle set D-116

Optionally for ThermoSafe, ThermoSafe Hybrid, ThermoPlan Hybrid, TopComfort and TopComfort Portal



Stainless steel lever handle set D-335

Optionally for ThermoSafe, ThermoSafe Hybrid, ThermoPlan Hybrid, TopComfort and TopComfort Portal



Aluminium lever handle D-360

black.edition in Jet black, RAL 9005 matt fine structure, optionally for ThermoSafe, ThermoSafe Hybrid, ThermoPlan Hybrid and ThermoCarbon



Aluminium lever handle D-360

In Traffic white, RAL 9016, optionally for ThermoSafe, ThermoSafe Hybrid, ThermoPlan Hybrid and ThermoCarbon



Stainless steel lever handle D-360

Optionally for ThermoSafe, ThermoSafe Hybrid, ThermoPlan Hybrid and ThermoCarbon



Stainless steel lever handle D-360

Optionally for ThermoSafe, ThermoSafe Hybrid, ThermoPlan Hybrid and ThermoCarbon



Aluminium security handle set 62-1

Optionally for ThermoSafe, ThermoSafe Hybrid, ThermoPlan Hybrid, TopComfort (not for RC3 security features) and TopComfort Portal



Stainless steel security handle set 62-4

In Traffic white RAL 9016, optionally for ThermoSafe, ThermoSafe Hybrid, ThermoPlan Hybrid, TopComfort (not for RC3 security features) and TopComfort Portal



Protective lever handle

Prevent unintentional door opening by pets:

Our protective lever handle opens only after approx.

87° instead of 25° as with conventional lever handles.

This means that door locking is not required. Of course,

our comfort functions such as the electric strike,

code switch or finger-scan stay the same.

→ Available for all aluminium entrance doors



Watch the video on YouTube or www.hoermann.de/mediacenter

Glazing

For door styles and side elements

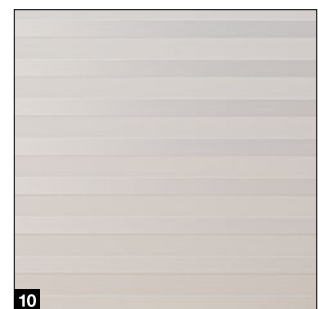
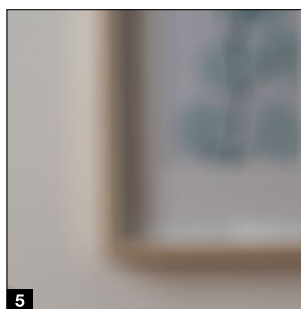
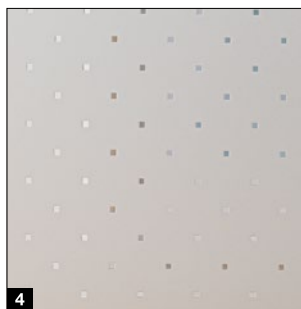
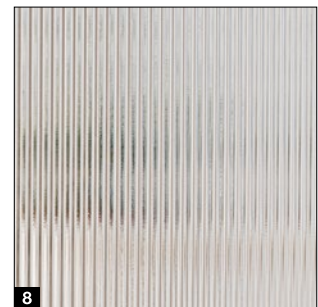
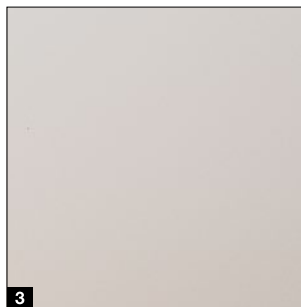
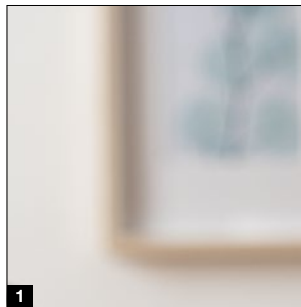

Only from Hörmann

10 mm P5A laminated safety glass and 8 mm laminated safety glass as standard

Safe glazing.

When it comes to industrial safety and burglar protection, Hörmann aluminium entrance doors fulfil the absolute highest demands. The laminated safety glass on the interior and exterior of the triple-pane insulated glazing provides maximum security. In case of glass breakage, the glass splinters are also bound on the inside, virtually eliminating any danger of being injured by the shards. Furthermore, the laminated safety glass offers better burglar protection as it makes reaching through more difficult.

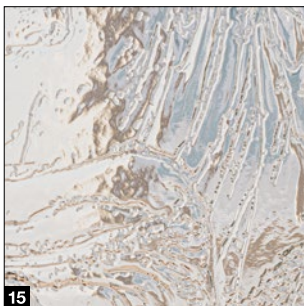
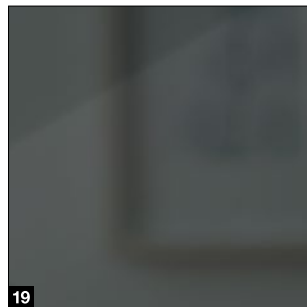
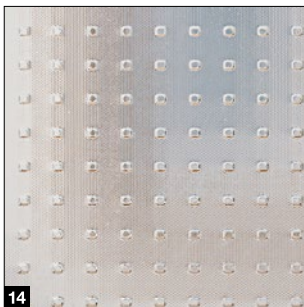
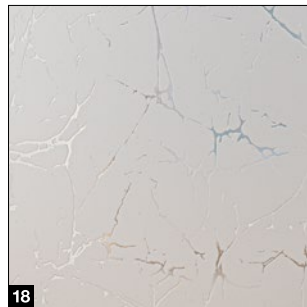
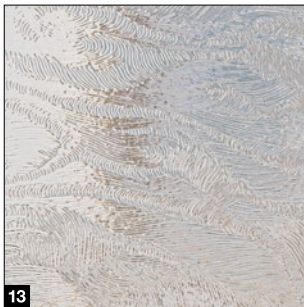
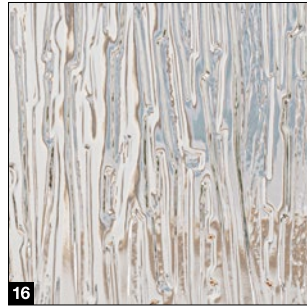

- 1 Float, clear / clear glass
- 2 Float, matt / sand-blasted
- 3 Float satin-finished
- 4 Pave white
- 5 Parsol grey
- 6 Parsol grey, matt
- 7 Ornament 504
- 8 Ornament 553
- 9 Chinchilla
- 10 Micrograin (Madras basic)
- 11 Reflo, clear
- 12 Reflo, matt
- 13 Silk
- 14 Master-Carré
- 15 Baroque white
- 16 Niagara white
- 17 Gothic white
- 18 Uadi white
- 19 Black glass

Dimensions and technical manual

ThermoSafe / ThermoSafe Hybrid

ThermoSafe / ThermoSafe Hybrid entrance door sizes

70 mm frame version	Overall frame dimension* (ordering size)	Structural opening*	Clear frame dimension
Standard	Max. 1250 × 2250	Max. 1270 × 2260	Max. 1110 × 2180
Oversize	Max. 1250 × 2350	Max. 1270 × 2360	Max. 1110 × 2280
XXL	Max. 1250 × 2500	Max. 1270 × 2510	Max. 1110 × 2430

ThermoSafe / ThermoSafe Hybrid side element sizes

Vertical profile construction	Side element height*	TM side element width*	TM entrance door width*
1-sided	Max. 3000	260 – 1600	Max. 1230
2-sided	Max. 3000	260 – 1600	Max. 1210

The maximum transport size of a door assembly (incl. side elements, transom lights and surface-mounted profiles) must not exceed 2700 mm on any side.

Coupling construction	Side element height*	TM side element width*	TM entrance door width*
1- / 2-sided	Max. 3000	300 – 2500	1250

* For 110 mm frames + +40 mm

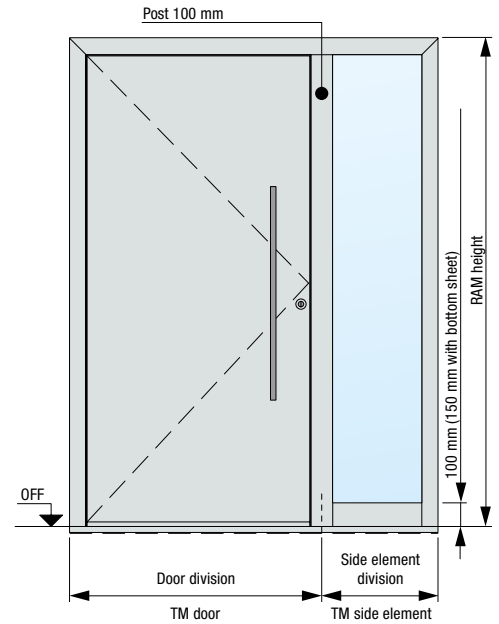

Horizontal view of door

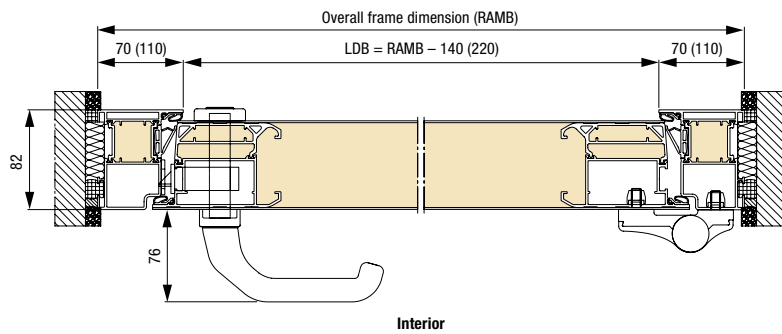

Vertical view of door

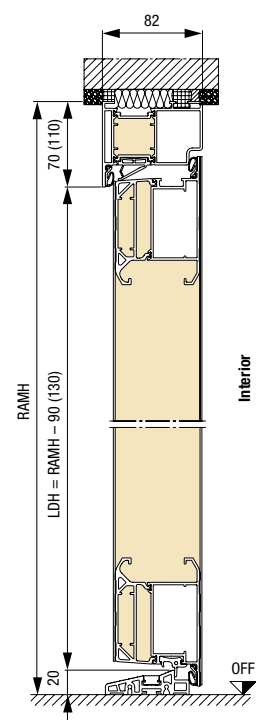

Bottom spacer profile / transport protection

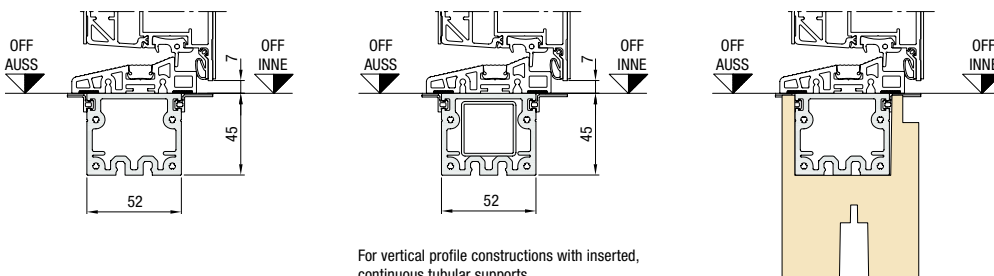

For vertical profile constructions with inserted, continuous tubular supports

Thermo floor recess for higher thermal insulation in the floor area

ThermoPlan Hybrid entrance door sizes

70 mm frame version	Overall frame dimension* (ordering size)	Structural opening*	Clear frame dimension
Standard	Max. 1250 × 2250	Max. 1270 × 2260	Max. 1110 × 2180
Oversize	Max. 1250 × 2350	Max. 1270 × 2360	Max. 1110 × 2280
XXL	Max. 1250 × 2500	Max. 1270 × 2510	Max. 1110 × 2430

ThermoPlan Hybrid side element sizes

Vertical profile construction	Side element height*	TM side element width*	TM entrance door width*
1-sided	Max. 3000	260 – 1600	Max. 1230
2-sided	Max. 3000	260 – 1600	Max. 1210

The maximum transport size of a door assembly (incl. side elements, transom lights and surface-mounted profiles) must not exceed 2700 mm on any side.

Coupling construction	Side element height*	TM side element width*	TM entrance door width*
1- / 2-sided	Max. 3000	300 – 2500	1250

* For 110 mm frames + +40 mm

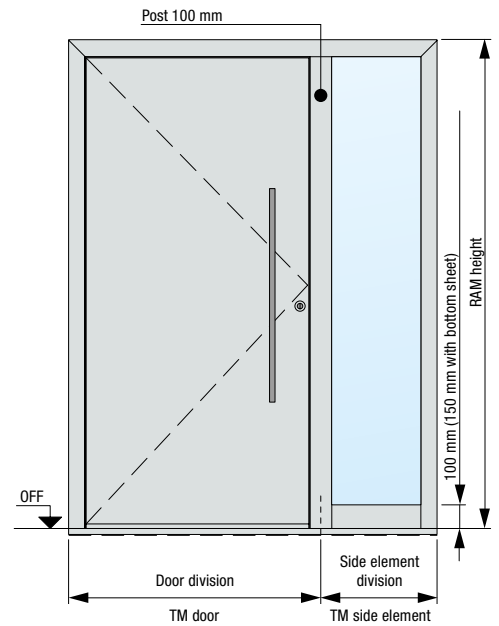

Horizontal view of door

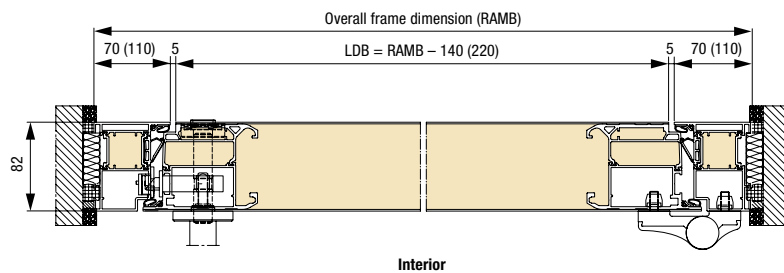

Vertical view of door

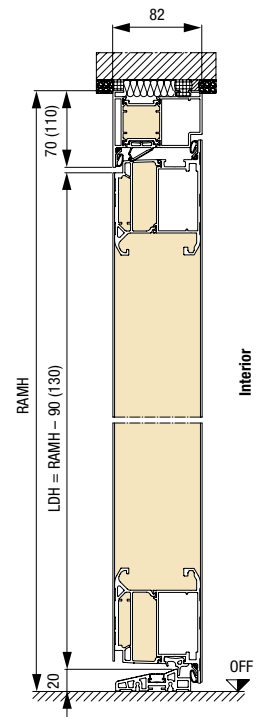

Bottom spacer profile / transport protection

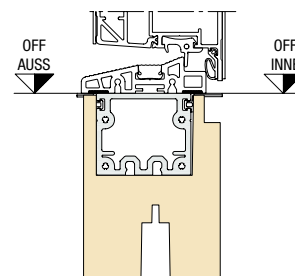
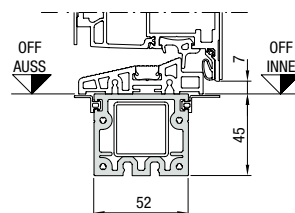
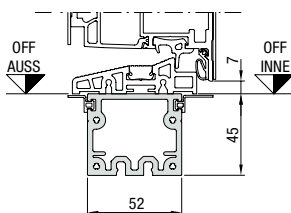

For vertical profile constructions with inserted, continuous tubular supports

Thermo floor recess for higher thermal insulation in the floor area

Dimensions and technical manual

ThermoCarbon

ThermoCarbon entrance door dimensions

Blackline	Overall frame dimension (ordering size)	Structural opening	Clear frame dimension
Standard	Max. 1340 × 2350	Max. 1360 × 2360	Max. 1140 × 2230
XXL	Max. 1340 × 3000	Max. 1360 × 3010	Max. 1140 × 2880

ThermoCarbon side element dimensions

Vertical profile construction	Side element height	TM side element width	TM entrance door width
1-sided	Max. 3000	300 – 1600	Max. 1300
2-sided	Max. 3000	300 – 1600	Max. 1260

The maximum transport size of a door assembly (incl. side elements, transom lights and surface-mounted profiles) must not exceed 2700 mm on any side.

Coupling construction	Side element height	TM side element width	TM entrance door width
1- / 2-sided	Max. 3000	340 – 1600	1340

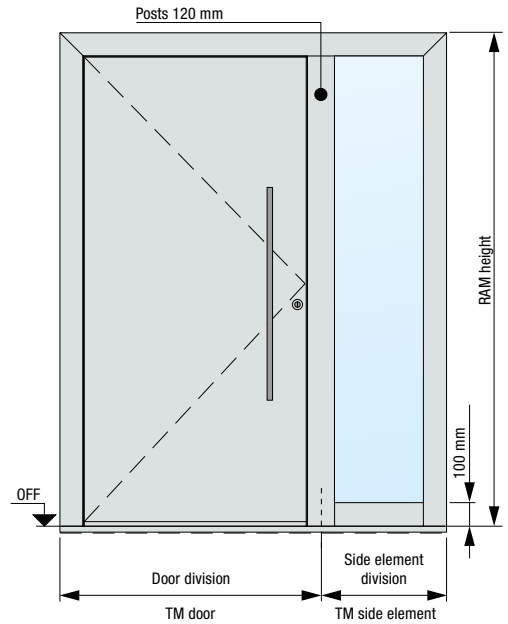

Horizontal view of door

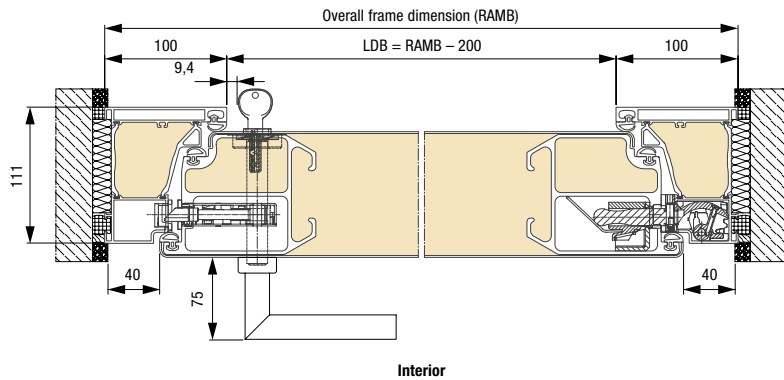

Vertical view of door

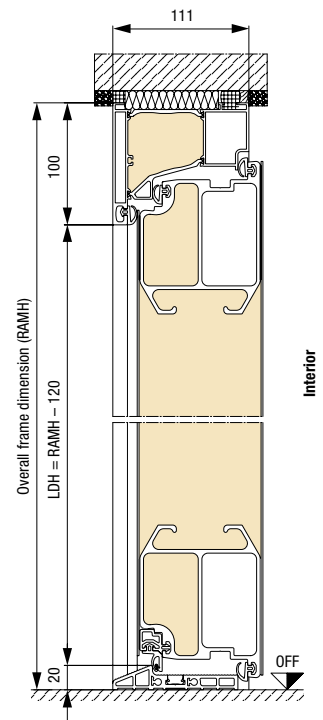

Bottom spacer profile / transport protection

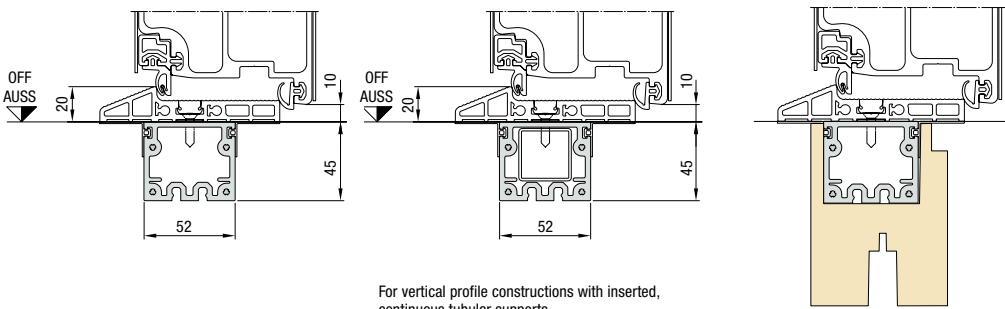

Thermo floor recess for higher thermal insulation in the floor area

TopComfort entrance door sizes

70 mm frame version	Overall frame dimension ¹⁾ (ordering size)	Structural opening ¹	Clear frame dimension
Standard	Max. 1300 × 2500	Max. 1270 × 2510	Max. 1160 × 2430

TopComfort side element sizes

Vertical profile construction	Side element height ¹⁾	TM side element width ¹⁾	TM entrance door width ¹⁾
1-sided	Max. 3000	260 – 1600	Max. 1230
2-sided	Max. 3000	260 – 1600	Max. 1210

The maximum transport size of a door assembly (incl. side elements, transom lights and surface-mounted profiles) must not exceed 2700 mm on any side.

Coupling construction	Side element height ¹⁾	TM side element width ¹⁾	TM entrance door width ¹⁾
1- / 2-sided	Max. 3000	300 – 1600	1250

¹⁾ For 110 mm frames + +40 mm

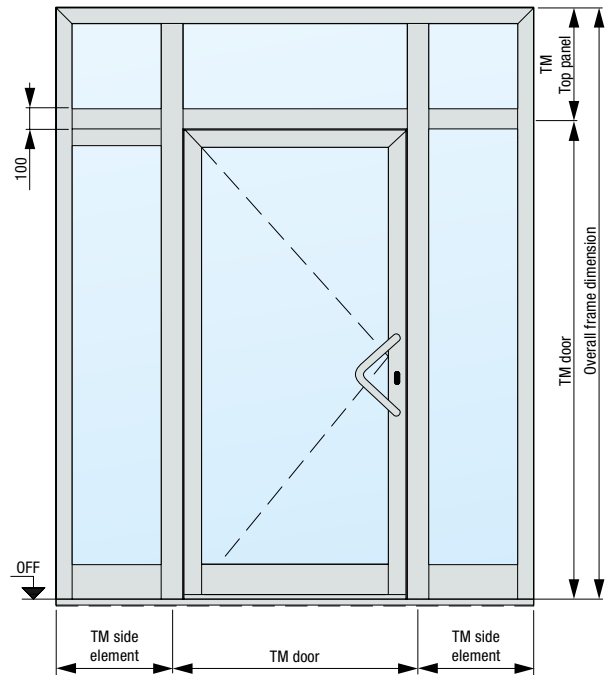

Horizontal view of door

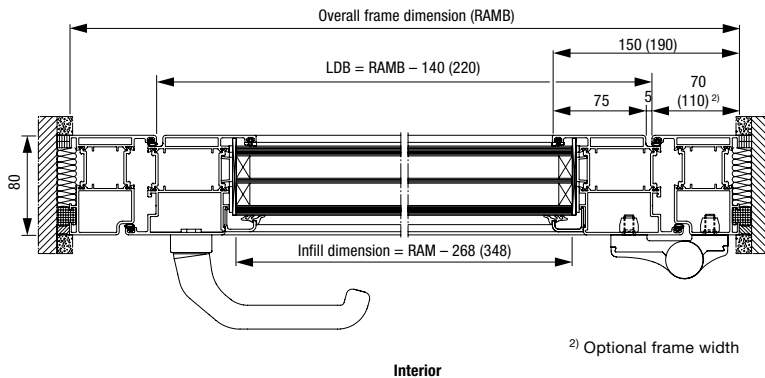

Vertical view of door

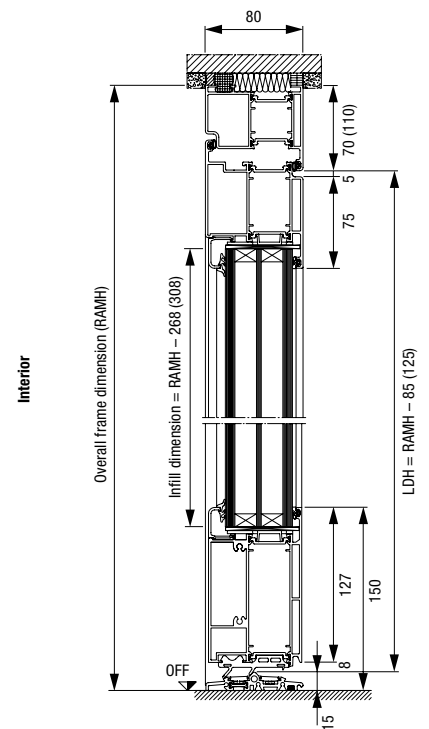

Bottom spacer profile / transport protection

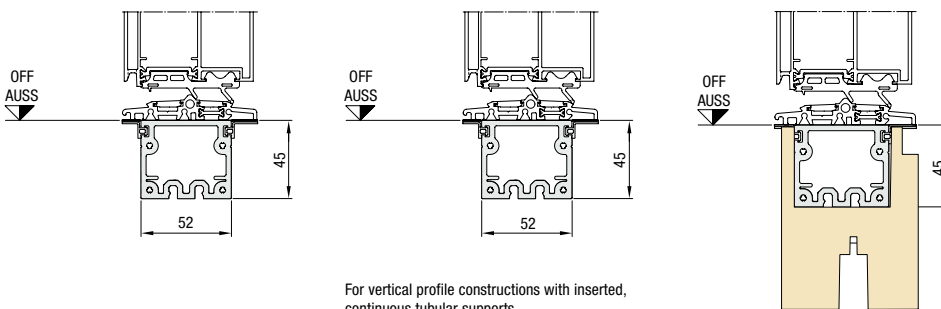

Thermo floor recess for higher thermal insulation in the floor area

Dimensions and technical manual

TopComfort Portal

TopComfort Portal entrance door sizes

Blackline	Overall frame dimension (ordering size)	Structural opening	Clear frame dimension
Standard	Max. 2600 × 2500	Max. 2620 × 2510	Max. 2400 × 2400

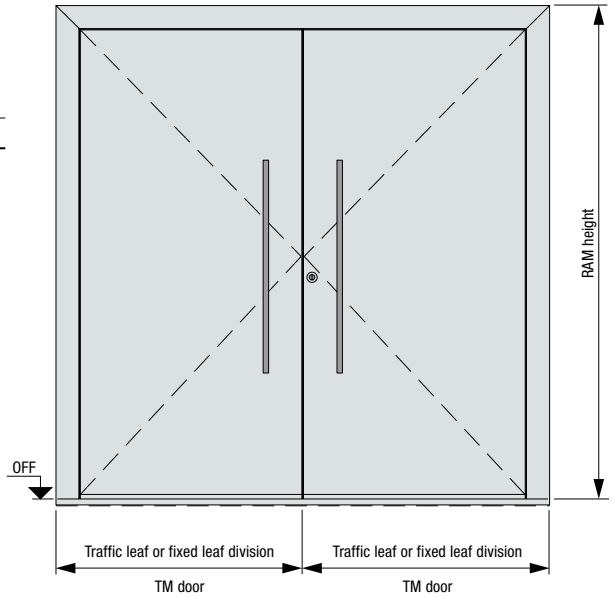

Horizontal view of door

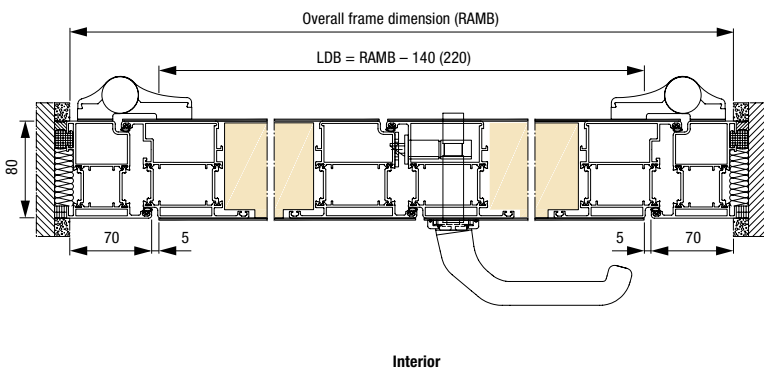

Vertical view of door

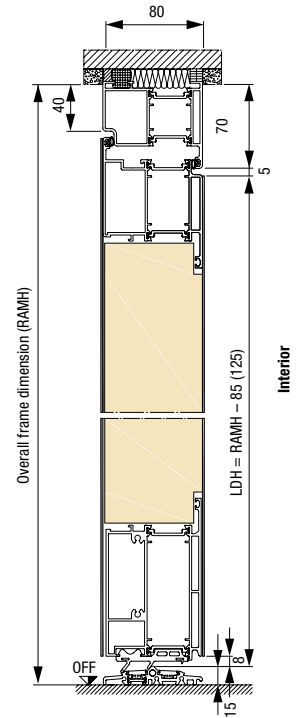

Bottom spacer profile / transport protection

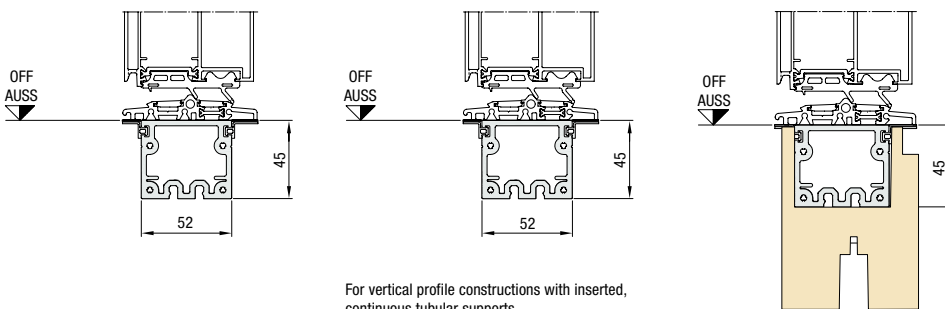

For vertical profile constructions with inserted, continuous tubular supports

Thermo floor recess for higher thermal insulation in the floor area



Hörmann. For Life.

Whether you are building your home or modernising it, you desire a place full of joy, security and relaxation. Thanks to their sustainable and particularly durable quality, Hörmann products will become a reliable part of your home – made to last for generations.

GARAGE DOORS. GATE AND DOOR OPERATORS. SMART HOME SYSTEMS. ENTRANCE DOORS. RESIDENTIAL INTERNAL DOORS. LOFT DOORS. STEEL DOORS. DOOR FRAMES. STORAGE SPACE SYSTEMS.

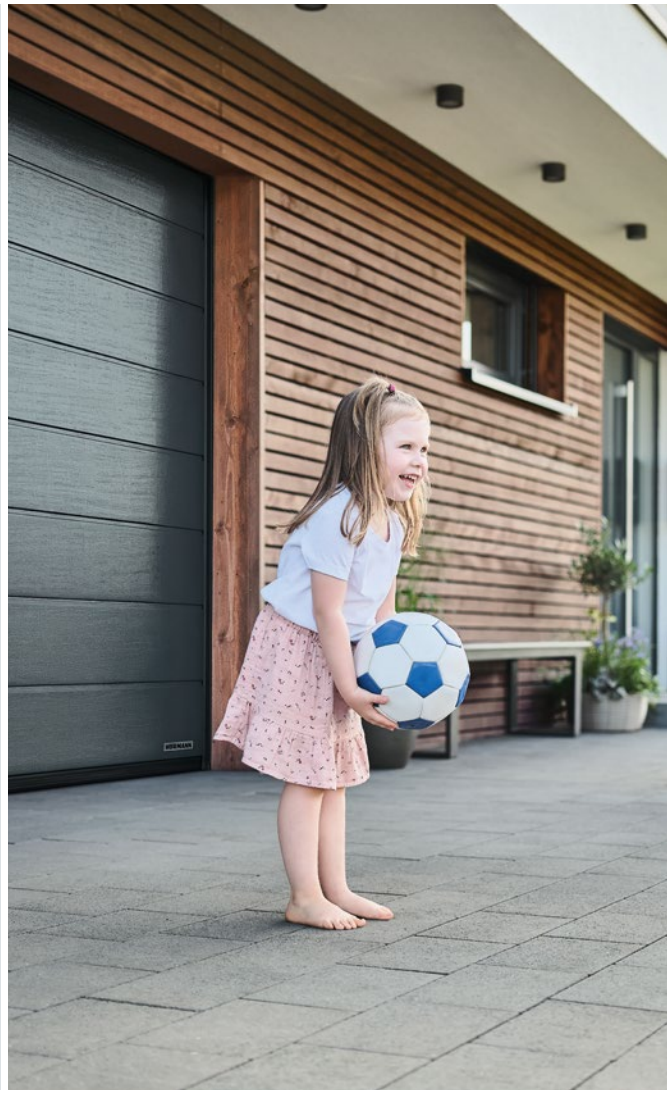

Some of the products shown are equipped with special equipment and do not always correspond to the standard versions. The surface finishes and colours shown are subject to the limitations of the printing process and cannot be regarded as binding. Protected by copyright. No part may be reproduced without our prior permission. Subject to changes.